



**RadioShack**

[www.radioshack.com](http://www.radioshack.com)



# PRO-92 Handheld Scanner

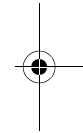
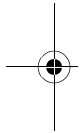

**Owner's Manual**  
Please read before using this equipment.

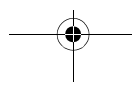

## Contents

<b>Features .....</b>	<b>5</b>
FCC Notice .....	8
Scanning Legally .....	8
<b>Preparation .....</b>	<b>9</b>
Power Sources .....	9
Using Batteries .....	10
Charging Rechargeable Batteries .....	12
Using AC Power .....	13
Using Vehicle Power .....	14
Connecting the Antenna .....	15
Connecting an Optional Antenna .....	15
Connecting an Earphone/Headphones .....	16
Listening Safely .....	16
Traffic Safety .....	17
Connecting an Extension Speaker .....	17
Using the Belt Clip .....	17
Connecting the Clone Cable .....	18
<b>About Your Scanner .....</b>	<b>18</b>
A Look at the Keypad .....	19
A Look at the Display .....	21
Understanding Banks .....	22
Channel Storage Banks .....	22
Search Banks .....	23
Understanding CTCSS/DCS .....	23
PL Codes .....	23
DPL Codes .....	23
Understanding Your Scanner's Modes .....	24
Open and Closed Modes .....	24
AM Mode .....	25
FM Mode .....	26
LTR (E. F. Johnson) Mode .....	26
Motorola Mode .....	27
EDACS Mode .....	28

© 2000 Tandy Corporation.  
All Rights Reserved.

RadioShack, RadioShack.com, and Adaptaplug are registered trademarks used by Tandy Corporation. Hypersearch and Hyperscan are trademarks used by Tandy Corporation.

LTR is a registered trademark of EF Johnson. Motorola, Smartnet and Privacy Plus are registered trademarks of Motorola Inc.

EDACS is a registered trademark of GE/Ericsson Inc.



**Operation ..... 29**

- Turning on the Scanner and Setting Squelch .... 29
- Storing Known Frequencies into Channels ..... 30
- Storing Text Tags ..... 31
  - Assigning a Text Tag to a Channel ..... 31
  - Assigning a Text Tag to a Bank ..... 32
  - Text Input Chart ..... 33
- Finding and Storing Active Frequencies ..... 34
  - Searching a Preprogrammed Frequency Range ..... 34
  - Storing a Frequency While Searching for a Specified Channel ..... 36
  - Changing a Search Range with a Preprogrammed Range ..... 36
  - Manually Changing a Search Range ..... 37
- Scanning the Channels ..... 37
  - Turning Channel-Storage Banks Off and On ..... 38
- Manually Tuning a Frequency ..... 38
- Deleting Frequencies from Channels ..... 39
- Listening To the Weather Band ..... 39
  - Listening to a Weather Channel ..... 39
  - Displaying Weather Messages ..... 39

**Special Features ..... 40**

- Using the Delay Function ..... 40
- Locking Out Channels or Frequencies ..... 41
  - Locking Out Channels ..... 41
  - Reviewing the Lock-Out Channels ..... 41
  - Locking Out Frequencies ..... 41
  - Reviewing Locked-Out Frequencies ..... 42
  - Clearing a Locked-Out Frequency ..... 42
  - Clearing All Lock Out Frequencies in a Search Bank ..... 42
- Priority ..... 43
- Changing the Receive Mode ..... 45
- Changing the Frequency Step ..... 45
- Using the Attenuator ..... 46
- Using the Display Backlight ..... 47
- Turning the Key Tone On and Off ..... 47
- Using the Keylock ..... 47
- Changing the Display Contrast ..... 47
- Cloning the Programmed Data from Scanner to Scanner ..... 48

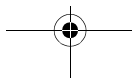
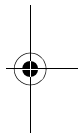
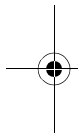



**Trunking Operation ..... 48**

- Understanding Trunking ..... 49
- Setting Squelch for the Trunking Mode ..... 50
- Programming Trunking Frequencies ..... 50
  - Programming Motorola Trunking Systems (UHF-Lo) ..... 51
- Programming Fleet Maps ..... 53
- Talk Group IDs ..... 54
  - Storing Talk Group IDs ..... 55
  - Talk Group ID Hold ..... 55
  - Locking Out Talk Group IDs ..... 56
  - Reviewing Locked-Out Talk Group IDs ..... 56
  - Clearing Talk Group IDs ..... 56
  - Clearing All Talk Group IDs in One Bank ... 56
- Open and Closed Modes ..... 57
  - Changing the Open/Closed Mode ..... 58

**A General Guide to Scanning ..... 58**

- Guide To Frequencies ..... 59
  - US Weather Frequencies ..... 59
  - Ham Radio Frequencies ..... 59
  - Birdie Frequencies ..... 59
- Guide to the Action Bands ..... 61
  - Typical Band Usage ..... 61
  - Primary Usage ..... 61
- Band Allocation ..... 62
- Frequency Conversion ..... 65

**Troubleshooting ..... 66**

- Resetting/Initializing the Scanner ..... 67
  - Resetting the Scanner ..... 67
  - Initializing the Scanner ..... 68

**Care ..... 68**

**Specifications ..... 69**

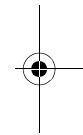
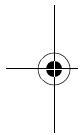



---

---

## **Features**

Your RadioShack Handheld Scanner is one of a new generation of scanners designed to track Motorola® Type I and Type II (such as Smartnet® and Privacy Plus®) and hybrid analog trunking systems, plus GE/Ericsson (EDACS®) and EF Johnson (LTR®) type systems, which are extensively used in many communication systems.

Trunking communications systems let a large group of 2-way radio users (or even different groups of 2-way radio users) efficiently use a set of frequencies. Instead of selecting a specific frequency for a transmission, the user simply selects a talk group. The trunking system automatically transmits the call on the first available frequency, and also sends a code that uniquely identifies that transmission.

Since the trunking system might send a call and its response on different frequencies, it is difficult to listen to trunked communications using a regular scanner. The scanner monitors the data sent with a 2-way radio transmission, so you can hear the call and response for that user and more easily “follow” the conversation.

The scanner also lets you scan conventional transmissions, and is preprogrammed with service search banks for convenience. By pressing a single button, you can quickly search those frequencies most commonly used by public service and other agencies without tedious and complicated programming.

This scanner gives you direct access to over 33,000 frequencies including those used by police and fire departments, ambulance services, government agencies, air, and amateur radio services.

Your scanner includes these features:

**Simultaneous Trunking Operation** — tracks three trunking systems (LTR, Motorola, and EDACS) and conventional systems at the same time.

**10 Channel-Storage Banks** — let you store 50 channels in each bank (500 channels) to group channels so calls are easier to identify.





**12-Character, 4-Line, Dot-Matrix Display** — shows you detailed operating information and lets you easily program the scanner.



**Weather Alert** — automatically sounds the alarm tone to advise of hazardous weather conditions when it detects the alert signal on the local National Oceanic and Atmospheric Administration (NOAA) weather channel during priority operation.

**Digital Weather Alert** — displays the weather event text so you can see the reason for the alert.

**Preprogrammed Frequency Ranges** — let you search for transmissions within preset frequency ranges or within ranges you set, to reduce search time and select interesting frequencies more quickly.

**Subaudible Tone Decode** — decodes and displays the Continuous Tone Coded Squelch System (CTCSS) tone signal being transmitted.

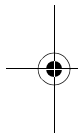

**Digital Subaudible Tone Decode** — decodes and displays the Digital Coded Squelch (DCS) being received.

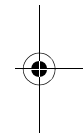

**Data Cloning** — lets you transfer the programmed data to another PRO-92 scanner. You can also upload or download the programmed data to or from a PC using an optional interface kit.

**Triple Conversion Superheterodyne Receiver** — virtually eliminates any interference from intermediate frequency (IF) images, so you hear only the frequency you select.

**Hyperscan™ and Hypersearch™** — the scanner scans at up to 25 channels per second and searches at up to 50 steps per second, to help you quickly find interesting transmissions.

**Scan Delay** — delays scanning for about 2 seconds before moving to another channel in conventional mode, so you can hear more replies that are made on the same channel.

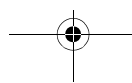



**Priority Channel** — you can set the scanner to check one channel every 2 seconds so you do not miss important calls.

**Signal Attenuation (Attenuate)** — lets you program each memory location to reduce the scanner's sensitivity to strong local signals, to reduce interference or noise caused by these signals.

**Text Input** — lets you input a text label for each channel, talk group ID, bank, or other memory location so you can easily know about the transmission you are hearing.

**Lock Out Function** — lets you set your scanner to skip over specified channels or frequencies when scanning or searching, and skip over IDs when tracking trunked systems.

**Key Lock** — lets you lock the scanner's keys to help prevent accidentally changing the scanner's programming.

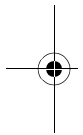

**Flexible Antenna with BNC Connector** — provides excellent reception and is designed to help prevent antenna breakage.

**Memory Backup** — keeps the frequencies stored in memory for an extended time even without internal batteries.

**Three Power Options** — let you power the scanner with internal batteries (non-rechargeable batteries or rechargeable batteries). You can also use an AC adapter (not supplied) or power the scanner in a vehicle using a DC adapter (not supplied).

**Supplied Police Call Trunking Guide** — provides a quick reference to public safety trunking radio systems in the United States.

Your scanner can receive these frequencies:

- 29–54 MHz
- 108–136.9875 MHz
- 137–174 MHz

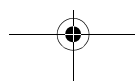
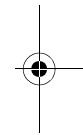



- 380–512 MHz
- 806–823.9875 MHz
- 849–868.9875 MHz
- 894–960 MHz



This Owner's Manual also includes the section "A General Guide to Scanning" on Page 58 to help you target frequency ranges in your service area so you can search for a wide variety of transmissions.

## FCC NOTICE

Your scanner might cause TV or radio interference even when it is operating properly. To determine whether your scanner is causing the interference, turn off your scanner. If the interference goes away, your scanner is causing the interference. Try the following methods to eliminate the interference.

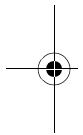

- Move your scanner away from the TV or radio.
- Connect your scanner to an outlet that is on a different electrical circuit from the TV or radio.
- Contact your local RadioShack store for help.

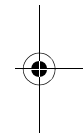

If you cannot eliminate the interference, the FCC requires that you stop using your scanner.

This device complies with Part 15 of the *FCC Rules*. Operation is subject to the following conditions: (1) this device must not cause harmful interference, and (2) this device must accept any interference received, including interference that may cause undesired operation.

**Note:** Mobile use of this scanner is unlawful or requires a permit in some areas. Check the laws in your area.

## SCANNING LEGALLY

Scanning is a fun and interesting hobby. You can hear police and fire departments, ambulance services, government agencies, private companies, amateur radio services, aircraft, and military operations. It is legal to lis-

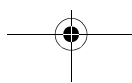



ten to almost every transmission your scanner can receive. However, there are some electronic and wire communications that are illegal to intentionally intercept. These include:

- telephone conversations (cellular, cordless, or other private means of telephone signal transmission)
- pager transmissions
- scrambled or encrypted transmissions

According to the *Federal Electronic Communications Privacy Act (ECPA)*, as amended, you could be fined and possibly imprisoned for intentionally listening to, using, or disclosing the contents of such a transmission unless you have the consent of a party to the communication (unless such activity is otherwise illegal). These laws change from time to time and there might be state or local laws that also affect legal scanner usage.

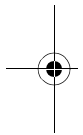

---

---

## **Preparation**

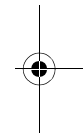

### **POWER SOURCES**

You can power your scanner from any of three sources:

- internal non-rechargeable batteries or rechargeable batteries (not supplied — see “Using Batteries” on Page 10)
- standard AC power (with an optional AC adapter — see “Using AC Power” on Page 13)
- vehicle power (with an optional DC adapter — see “Using Vehicle Power” on Page 14)

#### **Notes:**

- Connecting an AC or DC adapter to the scanner disconnects internal batteries when you use the supplied non-rechargeable battery holder, but it does not disconnect internal batteries when you use the supplied rechargeable battery holder.

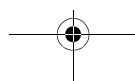



- If you install the rechargeable battery holder, you can operate the scanner and recharge the rechargeable batteries at the same time. See “Using Batteries” below and “Charging Rechargeable Batteries” on Page 12.
- If the scanner stops working properly after connecting it to power, try resetting it. See “Resetting/Initializing the Scanner” on Page 67.

## Using Batteries

You can power the scanner with six AA batteries. For the longest operation and best performance, we recommend alkaline batteries, available at your local RadioShack store.

You can use either the supplied non-rechargeable black battery holder, or the supplied rechargeable yellow battery holder. If you use the rechargeable battery holder, we recommend RadioShack nickel-cadmium or nickel-metal hydride batteries.

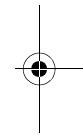
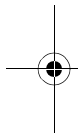

**Warning:** Never install non-rechargeable batteries in the rechargeable yellow battery holder. Non-rechargeable batteries can get hot or explode if you try to recharge them.

**Note:** You must charge rechargeable batteries before you use them the first time. See “Charging Rechargeable Batteries” on Page 12.

Follow these steps to install the batteries.

1. Press down on the battery compartment cover on the bottom of the scanner and slide the cover in the direction of the arrow to remove it.

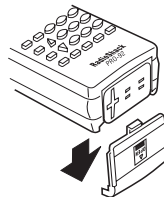

2. Pull out and slide the battery holder out of the battery compartment.



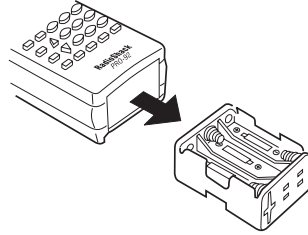

3. Insert six AA batteries in the battery holder as indicated by the polarity symbols (+ and -) marked on the holder.

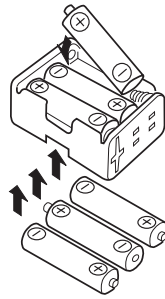

**Cautions:**

- Use only fresh batteries of the required size and recommended type.
- Always remove old or weak batteries. Batteries can leak chemicals that destroy electronic circuits.
- Do not mix old and new batteries, different types of batteries (alkaline or rechargeable), or rechargeable batteries of different capacities.

4. Slide the battery holder into the compartment.

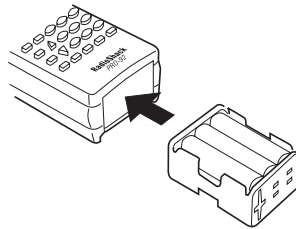



**Caution:** The battery holder fits only one way. Do not force it.



5. Replace the cover.

When battery power is low, **Low Battery!** appears and the scanner beeps continuously. When battery power is depleted, the scanner turns itself off. Replace all six non-rechargeable batteries, or recharge the rechargeable batteries. See “Charging Rechargeable Batteries.”

**Warning:** Always dispose of old batteries promptly and properly. Do not bury or burn them.

**Caution:** If you do not plan to use the scanner with batteries for a month or longer, remove the batteries. Batteries can leak chemicals that can destroy electronic parts.

### Charging Rechargeable Batteries

Your scanner has a built-in charging circuit that lets you charge rechargeable batteries (not supplied) while it is in the scanner. To charge rechargeable batteries connect an appropriate AC or DC adapter to the **PWR DC 9V** jack. We recommend RadioShack rechargeable batteries.

**Note:** To charge batteries with a DC adapter from a DC power source, you must use RadioShack Cat. No. 273-1825 and a size H Adaptaplug (neither supplied) available at your local RadioShack store. Make sure the adapter's voltage is set to 10V.

It takes between 14–16 hours to recharge rechargeable batteries that are fully discharged. You can operate the scanner while recharging the rechargeable batteries, but charging takes longer.

#### Notes:

- The scanner can charge Ni-MH batteries, however, these batteries require more than 24 hours to charge. We recommend using an external quick charger for Ni-MH batteries.
- Additional charging time is required for high-capacity rechargeable batteries.

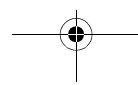
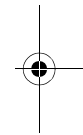
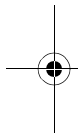



- Rechargeable batteries last longer and deliver more power if you let them fully discharge once a month. To do this, use the scanner until **Low Battery!** appears. Then fully charge the rechargeable batteries.



**Important:** The EPA certified RBRC<sup>®</sup> Battery Recycling Seal on the nickel-cadmium (Ni-Cd) battery indicates RadioShack is voluntarily participating in an industry program to collect and recycle these batteries at the end of their useful life, when taken out of service in the United States or Canada. The RBRC program provides a convenient alternative to placing used Ni-Cd batteries into the trash or the municipal waste stream, which may be illegal in your area. Please call 1-800-THE-SHACK (1-800-843-7422) for information on Ni-Cd battery recycling and disposal bans/restrictions in your area. RadioShack's involvement in this program is part of the company's commitment to preserving our environment and conserving our natural resources.

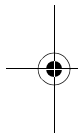

### Using AC Power

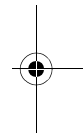

You can power the scanner using an 9V, 300 mA AC adapter and a size H Adaptaplug (neither supplied). We recommend RadioShack Cat. No. 273-1767 (available at your local RadioShack store).

#### Cautions:



You must use a Class 2 power source that supplies 9V DC and delivers at least 300 mA. Its center tip must be set to negative and its plug must fit the scanner's **PWR DC 9V** jack. Using an adapter that does not meet these specifications could damage the scanner or the adapter.

- Always connect the AC adapter to the scanner before you connect it to AC power. When you finish, disconnect the adapter from AC power before you disconnect it from the scanner.

Follow these steps to connect the adapter.

1. Connect the Adaptaplug to the adapter's cord with the tip set to negative.

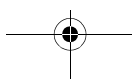



2. Plug the adapter's barrel plug into the scanner's **PWR DC 9V** jack.
3. Plug the adapter into a standard AC outlet.

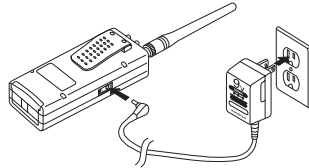

### Using Vehicle Power

You can power the scanner from a vehicle's 12V power source (such as a cigarette-lighter socket) using a 9V, 300 mA DC adapter and a size H Adaptaplug (neither supplied). We recommend RadioShack Cat. No. 273-1810 (available at your local RadioShack store).

**Note:** For charging batteries with an optional DC adapter from a DC power source, use RadioShack Cat. No. 273-1825 and a size H Adaptaplug (available at your local RadioShack store). Make sure the adapter's voltage is set to 10V.

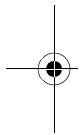

#### Cautions:



You must use a power source that supplies 9V DC and delivers at least 300 mA. Its center tip must be set to negative and its plug must fit the scanner's **PWR DC 9V** jack. Using an adapter that does not meet these specifications could damage the scanner or the adapter.

- Always connect the DC adapter to the scanner before you connect it to the power source. When you finish, disconnect the adapter from the power source before you disconnect it from the scanner.

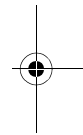

Follow these steps to connect the adapter.

1. Connect the Adaptaplug to the adapter's cord with the tip set to negative.
2. Plug the adapter's barrel plug into the scanner's **PWR DC 9V** jack.

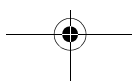

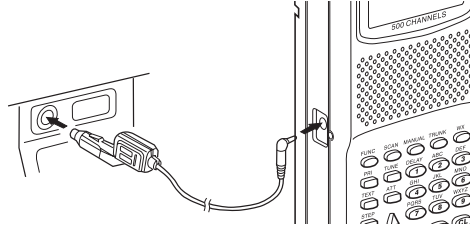

3. Plug the adapter's cigarette-lighter plug into your vehicle's cigarette-lighter socket.

**Note:** If the scanner does not operate properly when you connect a DC adapter, unplug the DC adapter from the cigarette-lighter socket and clean the socket to remove ashes and other debris.

### CONNECTING THE ANTENNA

Follow these steps to attach the supplied flexible antenna to the **ANT** jack on the top of your scanner.

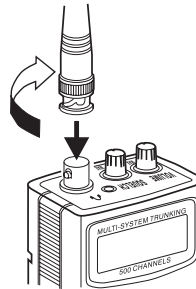

1. Align the slots around the antenna's connector with the tabs on the **ANT** jack.
2. Press the antenna down over the jack and turn the antenna's base clockwise until it locks into place.

### Connecting an Optional Antenna

The antenna connector on your scanner makes it easy to use the scanner with a variety of antennas, such as an external mobile antenna or outdoor base station antenna. Your local RadioShack store sells a variety of antennas.



Always use 50-ohm coaxial cable, such as RG-58 or RG-8, to connect an outdoor antenna. For lengths over 50 feet, use RG-8 low-loss dielectric coaxial cable. If your antenna's cable does not have a BNC connector, you will also need a BNC adapter (also available at your local RadioShack store).



Follow the installation instructions supplied with the antenna, route the antenna cable to the scanner, then connect it to the **ANT** jack.

**Warning:** Use extreme caution when installing or removing an outdoor antenna. If the antenna starts to fall, let it go! It could contact overhead power lines. If the antenna touches a power line, contact with the antenna, mast, cable or guy wires can cause electrocution and death! Call the power company to remove the antenna. Do not attempt to do so yourself.

## CONNECTING AN EARPHONE/ HEADPHONES

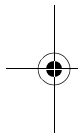

For private listening, you can plug an earphone or mono/stereo headphones (not supplied), available at your local RadioShack store, into the  jack on top of your scanner. This automatically disconnects the internal speaker.

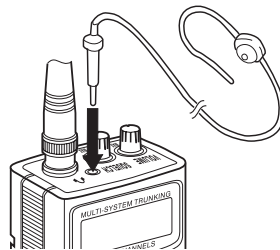
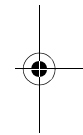

## Listening Safely

To protect your hearing, follow these guidelines when you use an earphone or headphones:

- Do not listen at extremely high volume levels. Extended high-volume listening can lead to permanent hearing loss.

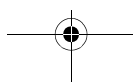



- Set the volume to the lowest setting before you begin listening. After you begin listening, adjust the volume to a comfortable level.
- Once you set the volume, do not increase it. Over time, your ears adapt to the volume level, so a volume level that does not cause discomfort might still damage your hearing.





### Traffic Safety

Do not wear an earphone or headphones while you drive a vehicle or ride a bicycle. This can create a traffic hazard and can be illegal in some areas.

Even though some earphones and headphones let you hear some outside sounds when you listen at normal levels, they still can present a traffic hazard.

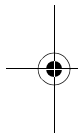
### CONNECTING AN EXTENSION SPEAKER



In a noisy area, an amplified speaker (not supplied), available at your local RadioShack store, might provide more comfortable listening. Plug the speaker cable's  $\frac{1}{8}$ -inch (3.5-mm) mini-plug into your scanner's  jack.

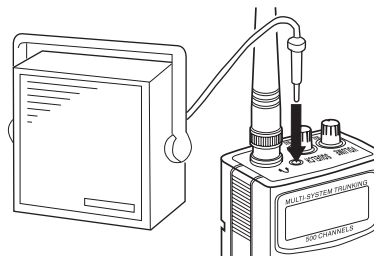
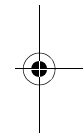

**Note:** You must use an amplified speaker with this scanner. Non-amplified speakers do not provide sufficient volume for comfortable listening.

### USING THE BELT CLIP

You can use the belt clip attached to the back of the scanner for hands-free carrying when you are on the go. Slide the belt clip over your belt or waistband.

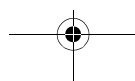



## CONNECTING THE CLONE CABLE



You can transfer the programmed data to and from another PRO-92 or PRO-2067 using the supplied clone cable. Connect the cable between each scanner's PC/IF jacks. See "Cloning the Programmed Data from Scanner to Scanner" on Page 48. You can also upload or download the programmed data to or from a PC using an optional PC interface kit available by special order from your local RadioShack store.

---

---

## **About Your Scanner**

Once you understand a few simple terms used in this manual and familiarize yourself with your scanner's features, you can put the scanner to work for you. You simply determine the type of communications you want to receive, then set the scanner to scan them.

A *frequency* is the receiving signal location (expressed in kHz or MHz). To find active frequencies, you can use the search function.

You can also search the SEARCH banks, which are pre-programmed frequencies in the scanner's memory (see "Searching a Preprogrammed Frequency Range" on Page 34 for the frequency list). You can change the SEARCH frequency ranges.

When you find a frequency, you can store it into a programmable memory location called a *channel*, which is grouped with your other channels in a *channel-storage bank*. You can then scan the channel-storage banks to see if there is activity on the frequencies stored there. Each time the scanner finds an active frequency, it stays on that channel until the transmission ends. See "Trunking Operation" on Page 48 for terms related to trunking systems.

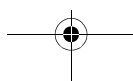
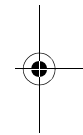
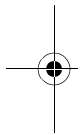

## A LOOK AT THE KEYPAD

Your scanner's keys might seem confusing at first, but this information should help you understand each key's function.



**FUNC (function)** — lets you use various functions by pressing this key along with other keys.

**SCAN** — scans through the programmed channels.

**MANUAL** — stops scanning and lets you directly enter a channel number.

**TRUNK** — stores the trunking ID code or holds the trunking ID while scanning.

**WX** — scans through the 7 preprogrammed weather channels.

**PRI (Priority)** — sets and turns the priority function on or off.

**TEXT** — lets you input text.

**STEP** — changes the frequency step or displays step frequency during search, or selects PL or DPL codes when programming.

**MODE** — changes the receive mode (AM, FM, PL, DL, LT, MO, ED). See "Changing the Receive Mode" on Page 45.

**LIT /LIT (Light)** — turns on/off the display's backlight or locks/unlocks the keypad to prevent accidental entries.



**TUNE** — lets you input a frequency and allows you to fine tune a frequency along with ▲ or ▼.



**ATT (Attenuate)** — turns attenuation on to reduce the scanner's sensitivity, or turns it off to increase it.

▲ or ▼ — selects the search direction during frequency search or tuning.

**SEARCH** — lets you search the ten search banks.

**L/OUT (Lock Out)** — lets you lock out a selected channel, skip a specified frequency during search, or lock out a selected ID code.

**PGM** — programs frequencies into channels.

**ENTER** — lets you complete the entry of frequencies and text.

**1/DELAY** — enters a 1, or programs a 2-second delay for the selected channel/search bank, or inputs characters 0 through 9.

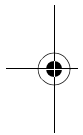

**2/ABC** — enters a 2, or inputs characters A, B, or C.

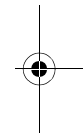

**3/DEF** — enters a 3, or inputs characters D, E, or F.

**4/GHI** — enters a 4, or inputs characters G, H, or I.

**5/JKL** — enters a 5, or inputs characters J, K, or L.

**6/MNO** — enters a 6, or inputs characters M, N, or O.

**7/PQRS** — enters a 7, or inputs characters P, Q, R, or S.

**8/TUV** — enters a 8, or inputs characters T, U, or V.

**9/WXYZ** — enters a 9, or inputs characters W, X, Y, or Z.

**0** — enters a zero, or inputs characters ., -, #, \_, @, +, \*, &, /, ', \$, %, !, ^, (, ), ?, →, ` , and ^.

● — enters a decimal point (necessary when programming frequencies), space, or hyphen (in Motorola type I code setting).

**CL** — clears an incorrect entry.

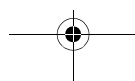

## A LOOK AT THE DISPLAY

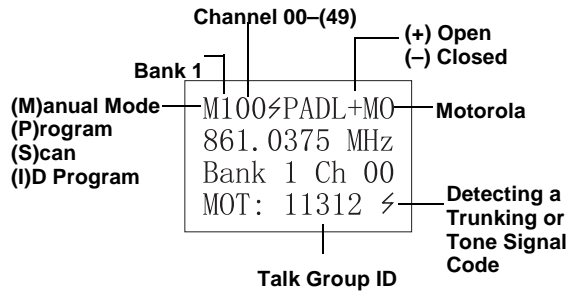
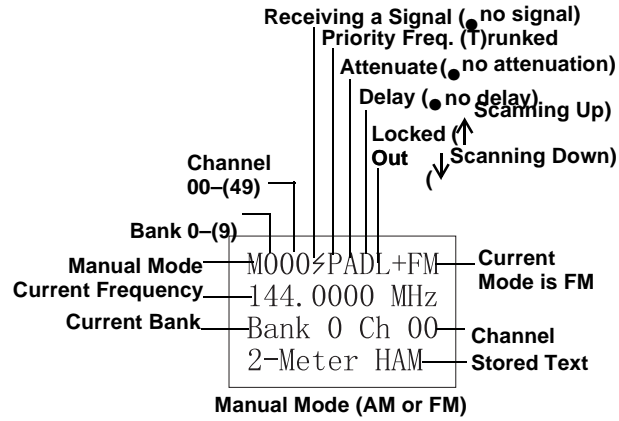

Note: If you enter the ID text tag in an ID code, the scanner displays it instead of the ID code and ↯.

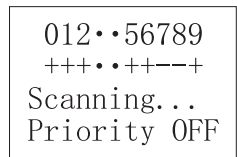

Scan Mode

- Bank Off
- Selected for Scanning
- + in Open Mode
- Selected for Scanning in Closed Mode

012345••89  
Search up...  
Priority OFF

6 and 7 are turned off

Search Mode

Searching Frequency for Range in Bank 3

Delay Scanning Up

Search Mode — SR-3↵••D↑•AM — AM

Current Frequency — 122.4500 MHz

Stepping — 25.0 kHz

Aircraft

Search Bank 5

Search Mode — SR-5↵••D↑•MO — Motorola

866.1250 MHz

12.5 kHz

MOT: 13456 ↵

## UNDERSTANDING BANKS

### Channel Storage Banks

To make it easier to identify and select the channels you want to listen to, channels are divided into 10 banks (0–9) of 50 (00 to 49) channels each. Use each channel-storage bank to group frequencies, such as those used by the police department, fire department, ambulance services, or aircraft (see “Typical Band Usage” on Page 61). For example, the police department might use four frequencies, one for each side of town. You could program the police frequencies starting with 000 (the 1st channel in bank 0) and program the fire department frequencies starting with 100 (the 1st channel in bank 1).



The 1st digit identifies the bank (0–9). The 2nd and 3rd digits identify the channel within the bank (00–49).



## Search Banks

This scanner is able to search 10 search banks. You can also replace a bank with one of the pre-programmed service bands. (For the default setting, see “Searching a Preprogrammed Frequency Range” on Page 34.)

**Note:** You can increase the number of preprogrammed frequency ranges your scanner can receive (up to 100) using an optional PC interface kit (available at your local RadioShack store).

## UNDERSTANDING CTCSS/DCS

Continuous Tone Coded Squelch System (CTCSS) and Digital Coded Squelch (DCS) are two methods used to prevent interference by other radio communications. Your scanner can receive transmissions that use these codes.

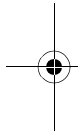

When your scanner receives a CTCSS transmission, **PL** (private line) appears. When your scanner receives a DCS transmission, **DPL** (digital private line) and a 3-digit code appear.

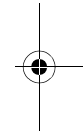

### PL Codes

PL codes are low-frequency audio tones that are used to differentiate different users on the same channel. PL codes appear according to the EIA standard CTCSS tones, and range from 67.0 Hz to 254.1 Hz. PL codes are displayed directly as a frequency.

### DPL Codes

DPL codes are similar to PL codes, except they might be transmitted as either tones or digital codes. Although there are as many as 4096 DPL codes, only about 100 are actually used.

DPL codes appear in the format **Dxxx**, where **xxx** is an octal code.

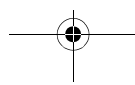



## UNDERSTANDING YOUR SCANNER'S MODES



You can program each channel with any of seven receive modes. Each mode affects how your scanner operates when scanning and receiving transmissions, and also affects what transmissions you receive when you set the scanner to the closed mode (see "Open and Closed Modes" on Page 57). The following sections describe each mode and how they affect your scanner's operation. See "Changing the Receive Mode" on Page 45.

PL, DPL and trunking systems all use some form of *coded squelch*. Coded squelch techniques involve the transmission of a special "code" signal along with the audio of a radio transmission. A receiver with coded squelch only activates when the received signal has the correct "code." This lets many users share a single frequency, and decreases interference caused by distant transmitters on the same channel.

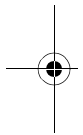

In all major metropolitan areas of the United States, every available radio channel is assigned to more than one user. Public safety radio systems on the same frequency are usually set up at a distance of 40 miles apart, or more. This means that you may hear transmissions from a distant system when your local system is not transmitting. By entering the PL for a local system, and operating the bank in closed mode, the scanner will not stop on transmissions from the distant system.

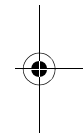

With few exceptions, such as the VHF Aircraft and Marine bands, almost every other VHF or UHF radio system uses some form of coded squelch. By far, PL is the most popular mode among non-trunked systems. For most scanning use, try setting PL mode for all non-trunked channels. If you operate the bank in open mode, the scanner will display the appropriate code.

### Open and Closed Modes

You can set your scanner to change the way it receives signals. These settings, called *open mode* and *closed mode*, affect how the scanner receives signals from communications systems that use some type of closed squelch (such as PL, DPL, LTR, MOT, and ED systems).

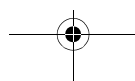



You can set each of the scanner's channel storage banks to open or closed mode.



In open mode, the scanner scans signals transmitted in all systems. In closed mode, the scanner scans signals transmitted only under the following conditions:

- When the signals are in the FM mode.
- When the signals are in the LT, MO, or ED mode *and* the signal's ID code matches the programmed ID code.
- When the signals are in the PL or DPL mode *and* the signal's ID code matches the programmed ID code.

**Note:** When the signals are in the PL or DPL mode, the scanner receives all signals on a channel when the ID code is set to NONE.

You can also select the users or talk groups you want the scanner to receive in closed mode.

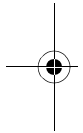

When you set a channel storage bank to open mode, + (open) appears under the bank's number while scanning. When you set a channel storage bank to closed mode, - (closed) appears under the channel storage bank's number while scanning. Or, **OPEN** or **CLOSED** appears while the scanner is in manual mode or while the scanner is receiving a signal during scanning.

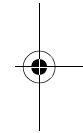

See "Changing the Open/Closed Mode" on Page 58 for more information about setting the open and closed modes.

## AM Mode

This sets the scanner to receive transmissions using amplitude modulation (AM). AM is used for aircraft, military, some amateur radio, and some government transmissions. When the scanner receives a transmission on a channel set to the AM mode, it always stops on the transmission.

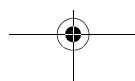



## FM Mode

This sets the scanner to receive transmissions using frequency modulation (FM). FM is used for most public safety transmissions, as well as broadcast, business, and amateur radio transmissions. When the scanner receives a transmission on a channel set to the FM mode, it always stops on the transmission.



## LTR (E. F. Johnson) Mode

You can set your scanner so it decodes the talk group IDs used with LTR systems. This setting is called the *LTR mode*.

LTR systems are trunking systems used primarily by business or private communications service providers, such as taxicabs, delivery trucks, and repair services. These systems encode all trunking information as digital subaudible data that accompanies each transmission. Users on an LTR system are assigned to specific talk groups, which are identified by the radio as six-digit numbers. These numbers are in the form **AHHUUU**, where:

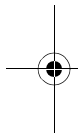

**A** = Area code (0 or 1)

**H** = Home repeater (01 through 20)

**U** = User ID (000 through 254)

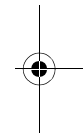

When the scanner receives a transmission on a channel set to the LTR mode, it first decodes the LTR data included with the transmission. In the open mode, the scanner stops on the transmission and displays the talk group ID on the bottom line of the display. In the closed mode, the scanner only stops on the transmission if the LTR data matches a talk group ID that you have stored in the bank's talk group ID list and have not locked out.

LTR systems are frequently programmed so that each radio has a unique ID code.

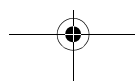



## Motorola Mode



You can set your scanner so it decodes the talk group IDs used with Motorola trunking systems. This setting is called the *Motorola mode*.

Motorola systems are trunking systems used primarily by business and public safety groups to efficiently allocate a small number of frequencies (as few as 5) to many groups of users (as many as several thousand). To do this, each group of users in the system is assigned to a specific talk group. For example, the east side patrol officers might all be assigned to talk group 2160. One channel in the system is continuously transmitting data that identifies which talk groups are active on which channel. In addition, this talk group information is also transmitted as subaudible data on each active channel.

When the scanner receives a transmission on a channel set to the Motorola mode, it first decodes the talk group ID data included with the transmission. In the open mode, the scanner stops on the transmission and displays the talk group ID on the bottom line of the display. In the closed mode, the scanner only stops on the transmission if the talk group ID matches a talk group ID that you have stored in the bank's talk group ID list and have not locked out.

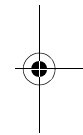
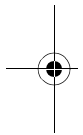

Motorola trunking systems come in three categories: *Type I*, *Type II*, and *Type III Hybrid*. Each category displays and uses talk group IDs in slightly different ways.

Motorola Type I IDs are in the form **FFF-SS**, where:

**FFF** = Fleet ID

**SS** = Subfleet ID

Type I systems are usually organized with different user groups assigned to different fleets. For example, a valid fleet/subfleet ID identifying all detectives within a police department might be **000-12**, where **000** identifies all police users and **12** identifies the Detective division.

To properly map the raw Type I data to the correct fleet-subfleet format, you must program the correct fleet map into the scanner. Fleet map information is

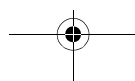



widely available on the Internet for most Type I systems in use.



Type II system talk groups are identified by a 5-digit number. Valid talk group IDs are divisible by 16. If you try to enter an invalid talk group ID, the scanner rounds the ID down to the next valid ID.

Type I/II hybrid systems use both fleet-subfleet and 5-digit formats for talk group IDs.

**Note:** If the scanner decodes control channel data while receiving transmissions from a Motorola trunking system, **CNTRL** appears on the bottom line of the display.

### EDACS Mode

You can set your scanner so it decodes the talk group IDs used with EDACS (GE/Ericsson) trunking systems. This setting is called the *EDACS mode*.

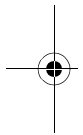

EDACS systems are trunking systems used primarily by business or private communications service providers, as well as by some public safety organizations. EDACS systems transmit active talk group information only on a dedicated control channel.

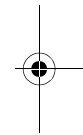

EDACS frequencies are organized in a specific order. Each frequency is assigned a Logical Channel Number (LCN). For the scanner to correctly switch to an active frequency, you must program the frequencies in LCN order, starting with Memory 01. EDACS talk group IDs are entered as a 4-digit decimal number from 0000 to 4095.

When there is activity on an EDACS system, that information is sent out on the control channel. The scanner decodes the ID for the active talk group. In the open mode, the scanner then goes to the transmission and displays the talk group ID on the bottom line of the display. In the closed mode, the scanner only goes to transmissions with IDs that match talk group IDs you have stored in the bank's talk group ID list which are not locked out.

Because EDACS scanning requires clear reception of the control channel at all times, EDACS systems tend to have a smaller usable area. An external antenna can

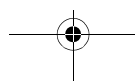

greatly improve EDACS scanning in a fringe area. If you are having trouble scanning an EDACS system, try manually selecting the data channel. If you are getting good reception, the scanner will indicate talk group **CTL-01**. Try changing your location or using an outdoor antenna to improve reception.

---

---

## □ *Operation*

### TURNING ON THE SCANNER AND SETTING SQUELCH

1. Turn **SQUELCH** fully counterclockwise until the indicator points to **MIN** before you turn on the scanner.

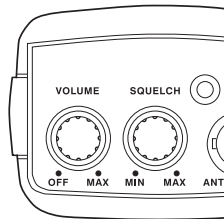

2. To turn on the scanner, turn **VOLUME** clockwise. **Welcome To Multi-System Trunking** appears. After about 3 seconds, you hear a hissing sound.
3. Turn **SQUELCH** clockwise, just until the hissing sound stops.
4. To turn off the scanner when you finish, turn **VOLUME** counterclockwise to **OFF**.

#### **Notes:**

- The scanner does not scan if there are no frequencies stored in channels. If the scanner does not scan and you have already stored frequencies in channels, turn **SQUELCH** further clockwise.
- If the scanner picks up unwanted, partial, or very weak transmissions, turn **SQUELCH** clockwise to decrease the scanner's sensitivity to these sig-



nals. If you want to listen to a weak or distant station, turn **SQUELCH** counterclockwise.

- If **SQUELCH** is adjusted so you always hear a hissing sound, the scanner will not scan properly.
- To ensure the scanner operates properly while in the trunking mode, we suggest you set **SQUELCH** using the above steps, even if the scanner is automatically muted.

## STORING KNOWN FREQUENCIES INTO CHANNELS

Good references for active frequencies are RadioShack's *Police Call*, *Aeronautical Frequency Directory*, and *Maritime Frequency Directory*. We update these directories every year, so be sure to get a current copy. Also see the supplied *Police Call Trunking Guide*.

Follow these steps to store frequencies into channels.

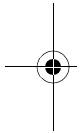

1. Press **MANUAL**, enter the channel number where you want to store a frequency, then press **MANUAL** again. **M** and the channel number appears at the upper left corner of the display (for example: M100).

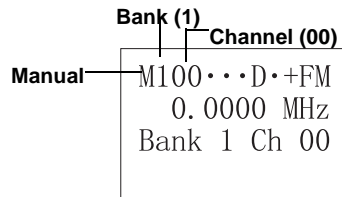
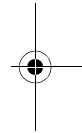

2. Press **PGM**. **M** changes to **P**.
3. Use the number keys and **•** to enter the frequency (including the decimal point) you want to store.

If you make a mistake, hold down **CL** for about 1 second to delete a single digit and about 2 seconds to delete all digits.

4. Press **ENTER** to store the frequency into the channel. The blinking cursor disappears.

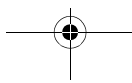



#### Notes:

- If you made a mistake in Step 3, **Invalid Freq** briefly appears and the scanner beeps when you press **ENTER**. Start again from Step 3.
- Your scanner automatically rounds the entered frequency to the nearest valid frequency. For example, if you enter a frequency of 151.473, your scanner accepts it as 151.470.
- Press **FUNC** then **DELAY/1** to turn the delay function on or off. To have the scanner pause for 2 seconds on this channel after a transmission before proceeding to the next active transmission, see "Using the Delay Function" on Page 40. The scanner stores this setting in the channel.
- If you are storing frequencies for an EDACS system, you must store them in logical channel number order, with the first frequency in channel 1 for the current bank.

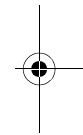
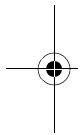

5. If necessary, press **MODE** to change the receiving mode. If you select **P/L** or **DPL**, enter the PL or DPL code by pressing **STEP** (to move up through the codes) or **FUNC** then **STEP** (to move down through the codes).
6. If desired, program a text tag for the channel (see "Assigning a Text Tag to a Channel").
7. The next channel in sequence is ready for programming. Press **PGM** and then repeat Steps 3 through 5.

## STORING TEXT TAGS

You can customize your scanner by storing text tags (up to 12 characters) for easy identification of channel transmissions, trunk IDs, or banks.

### Assigning a Text Tag to a Channel

1. Press **MANUAL**, enter the channel number where you want to enter the text, then press **MANUAL** again. **M** and the channel number appear at the upper left corner of the display (for example: **M100**).

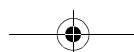



2. Press **PGM**. **M** changes to **P**.
3. Press **TEXT**. The cursor appears at the 3rd line.
4. Enter the text using the numeral keys (see "Text Input Chart" on Page 33).

**Note:** If you make a mistake, press **▼** or **▲** to move to the character you want to change.

For example input "HAM 6m" as follows:

- "H" is the second letter associated with 4 on the keypad. Press **4** then **2**.
- "A" is the first letter associated with 2 on the keypad. Press **2** then **1**.
- "M" is the first letter associated with 6 on the keypad. Press **6** then **1**.
- "Space." Press **•**.
- "6" is the sixth number associated with 1 on the keypad. Press **1** then **6**.
- "m" is the first letter associated with 6 on the keypad. Press **6** and **FUNC** (for the lower case set), then press **1**.

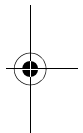
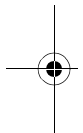

5. Press **ENTER** to input the text.

### Assigning a Text Tag to a Bank

1. Press **PGM**.
2. Select a channel within the desired bank by pressing **MANUAL** and entering the bank number (000 for bank 0 or 200 for bank 2, for example). Press **MANUAL** again, then press **PGM**.
3. Press **FUNC** then **6**. The cursor appears at the 3rd line of the display. Enter the text using the keypad and press **ENTER**.

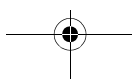
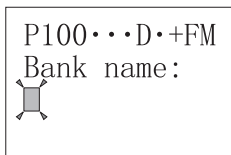

**Note:** If the channel is programmed for P/L, DPL, LTR, MOT or ED mode, the scanner displays the mode information on the 4th line.

### Text Input Chart

**Notes:**

- To access the numbers, after you press **FUNC** and **6**, press **1**, then press the desired number you want to enter.
- To enter a lowercase character or a character from the second set for key **0**, press **FUNC** after pressing the first numeral key.

Press	To Enter a Character from this Group
1	1 2 3 4 5 6 7 8 9 0
2	A B C
FUNC 2	a b c
3	D E F
FUNC 3	d e f
4	G H I
FUNC 4	g h i
5	J K L
FUNC 5	j k l
6	M N O
FUNC 6	m n o
7	P Q R S
FUNC 7	p q r s
8	T U V
FUNC 8	t u v

Press	To Enter a Character from this Group
9	W X Y Z
FUNC 9	w x y z
0	. - # _ @ + * & / '
FUNC 0	\$ % ! ^ ( ) ? → ` ^
.	Space
CL	Back Space

## FINDING AND STORING ACTIVE FREQUENCIES

You can search for transmissions within ten ranges of frequencies, called search banks. The search bank is divided into 10 search bands. You can change the bands with the preprogrammed search bands in the scanner (see "Search Banks" on Page 23). You can also change the search bank's search ranges manually.

### Notes:

- You can use the scanner's delay feature while searching the service bank. See "Using the Delay Function" on Page 40.
- The scanner does not search locked-out frequencies while searching ranges.

## Searching a Preprogrammed Frequency Range

The scanner contains these preprogrammed search ranges, stored in search banks (0-9).

Search Bank	Search Range (MHz)	Description
0	460-460.625	Police
1	153.725-156.000	Police/Fire
2	462.925-463.175	Medical

Search Bank	Search Range (MHz)	Description
3	118.000–136.00	Aircraft
4	156.250–157.425	Marine
5	866.000–868.9875	800 MHz
6	50.000–54.000	6 Meter Ham
7	144.000–148.000	2 Meter Ham
8	440.000–450.000	70 cm Ham
9	462.550–462.725	User Bank

Follow these steps to select preprogrammed search ranges and search them for active frequencies.

1. Press **SEARCH**. The scanner searches the active search bank.

Current  
Search  
Bank

0123456789  
Search up...

Priority OFF

**Note:** To reverse a search direction, press ▲ or ▼.

2. Using the number keys, enter the search bank number for each search range you want to select or remove.
3. When the scanner finds an active frequency, it stops searching. To save the frequency into a channel in the channel storage bank (bank 9 only), press **FUNC** then **ENTER**. **Stored @ 9xx** appears (xx: channel number). Press ▼ or ▲ to continue searching for additional active frequencies.

**Notes:**

- During search, you can manually change the band mode or frequency step. See “Changing the Receive Mode” on Page 45 or “Changing the Frequency Step” on Page 45.



- If bank 9 in the channel storage banks does not contain any empty channels, **Bank 9 full.** appears on the display's lower line.



### Storing a Frequency While Searching for a Specified Channel

1. When the scanner stops on the frequency, press **FUNC** then **TUNE**.
2. Press **MANUAL**. Select the specified channel using a number key, then press **MANUAL** again.
3. Press **PGM**.
4. Press **FUNC** then **TUNE** to store the frequency.
5. If desired, press **SEARCH** to resume searching.

### Changing a Search Range with a Preprogrammed Range

You can replace the search range with one of the preprogrammed ranges.

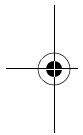

1. Press **FUNC** then **SEARCH** to enter search program mode. **PSR** and the search bank number of the current range appear at the display's upper left corner.

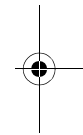

PSR0...D•+PL
460.0000 MHz
460.6250 MHz
25.0 kHz

2. Press **▲** or **▼** to select the search bank you want to replace.
3. Press **FUNC** then **5. ?SR** and the search bank number appear at the display's upper left corner.

?SR0...D•+AM
118.0000 MHz
136.9750 MHz
Air Band

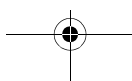



**Note:** After you press **FUNC**, press **5** within about 3 seconds. Otherwise, begin over at Step 1.

4. Press **▲** or **▼** to select the preprogrammed search range.
5. Press **ENTER** to replace the search range, then press **SEARCH** to begin searching.

### Manually Changing a Search Range

1. Press **FUNC** then **SEARCH** to enter search program mode. **PSR** and a search bank number appear at the display's upper left corner.
2. Press **▲** or **▼** to select the search bank number.
3. Use the number keys to enter the lower range you want to search and store, then press **ENTER** to store the frequency.
4. Use the number keys to enter the higher range you want to search and store, then press **ENTER** again to store the frequency.

**Notes:**

- If you enter a higher frequency first then enter a lower frequency, the scanner automatically exchanges the frequencies on the display. It displays the lower frequency first and the higher frequency second.
  - You cannot span across frequency bands. When manually setting search ranges, if you enter frequencies on different bands, the scanner does not accept the entry.
5. To assign a new name to the search range, press **TEXT** twice then enter the name. If you want to edit existing text, repeatedly press **▲** or **▼** to move the cursor across the text. Enter the appropriate text and press **ENTER**, then press **SEARCH** to resume searching.

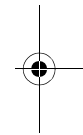
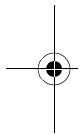

### SCANNING THE CHANNELS

To begin scanning channels or to start scanning again after monitoring a specific channel, press **SCAN**.

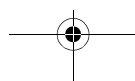



**Note:** You must store frequencies into channels before the scanner can scan them. The scanner does not scan empty channels.



The scanner scans through all channels (except those you have locked out) in the active banks (see "Turning Channel-Storage Banks Off and On" and "Locking Out Channels or Frequencies" on Page 41).

### Turning Channel-Storage Banks Off and On

To turn off banks while scanning, press the bank's number key until the bank's number disappears. The scanner does not scan any of the channels within the banks you have turned off.

**Notes:**

- You cannot turn off all banks. There must be at least one active bank.
- You can manually select any channel in a bank, even if the bank is turned off.

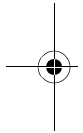

To turn on banks while scanning, press the number key until the bank's number appears.

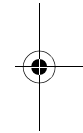

### MANUALLY TUNING A FREQUENCY

1. Press **TUNE**.
2. Use the number keys to enter the frequency.
3. Press **ENTER**.
4. Press **▲** to move up one tuning step. Press **▼** to move down one tuning step. To move up or down in 1 MHz increments, press **FUNC** then **▲** or **▼** for each increment.

To save the frequency into a channel (bank 9 only), press **FUNC** then **ENTER**. **Stored @ 9xx** appears (xx is the channel number).

When the scanner stops on a frequency while searching, press **FUNC** then **TUNE**.

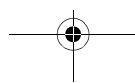



**Notes:**

- You cannot change the step frequency while tuning.
- You can change the receiving mode while tuning.

**DELETING FREQUENCIES FROM CHANNELS**

1. Press **MANUAL**.
2. Use the number keys to enter the channel with the frequency you want to delete.
3. Press **MANUAL** again.
4. Press **PGM** to enter the program mode. **M** changes to **P**.
5. Press **FUNC**.
6. Press **CL**. The frequency number changes and **0.0000 MHz** appears.

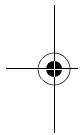

**LISTENING TO THE WEATHER BAND**

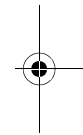

The FCC (Federal Communications Commission) has allocated channels for use by the National Oceanic and Atmospheric Administration (NOAA). Regulatory agencies in other countries have also allocated channels for use by their weather reporting authorities.

NOAA and your local weather reporting authority broadcast your local forecast and regional weather information on one or more of these channels.

**Listening to a Weather Channel**

To hear your local forecast and regional weather information, press **WX**. Your scanner scans through the weather band then stops within a few seconds on the strongest weather broadcast.

**Displaying Weather Messages**

The weather service precedes each weather alert with a digitally-encoded SAME signal, then a 1050 Hz tone. You can set the scanner so, if you are monitoring a

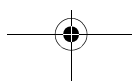



weather channel with a digitally-encoded SAME signal when an alert is broadcast, the scanner will decode and display the SAME message, showing the type of alert being broadcast (or **Unknown Message** if it does not recognize the event code).



To set the scanner to decode and display SAME messages, press **FUNC** then **WX** while you listen to the weather channel. **DIG WX STBY** and **Cancel : F+WX** appear.

To set the scanner out of the SAME standby mode, press **FUNC** then **WX** again. **DIG WX STBY** disappears.

**Notes:**

- The scanner does not display the actual location referenced by SAME messages. It uses only the message portion of the SAME signal.
- Your scanner can also receive weather alert tones (see "Priority" on Page 43).

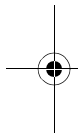

---

---

## **Special Features**

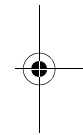

### **USING THE DELAY FUNCTION**

**Note:** Delay is automatically set as the default for each channel when you turn on the scanner.

Many conversations might have a pause of several seconds between a query and a reply. To avoid missing a reply, you can program a 2-second delay into any of your scanner's channels. Then, when the scanner stops on the channel, **D** appears and the scanner continues to monitor the channel for 2 seconds after the transmission stops before it resumes scanning or searching.

To turn delay on or off, press **FUNC** then **DELAY**.

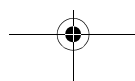



## LOCKING OUT CHANNELS OR FREQUENCIES



You can scan existing channels or search frequencies faster by locking out channels or frequencies that have a continuous transmission, such as a weather channel.

### Locking Out Channels

To lock out a channel while scanning, press **L/OUT** when the scanner stops on the channel. To lock out a channel manually, select the channel then press **L/OUT** until **L** appears.

#### Notes:

- You can still manually select locked-out channels.
- If you lock out a channel that is set to a Motorola trunking mode while using the subaudible decoding mode, you can remove the lockout by removing then reapplying power to the scanner. This makes it easy to temporarily lock out trunking data channels.

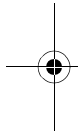

To remove the lockout from a channel, manually select the channel and press **L/OUT** until **L** disappears.

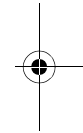

### Reviewing the Lock-Out Channels

To review all channels that are locked out, press **MANUAL**, then repeatedly press **FUNC** then **L/OUT** to view each locked-out channel. When you finish reviewing locked-out channels, press **MANUAL**.

### Locking Out Frequencies

To lock out a frequency during a search, press **L/OUT** when the scanner stops on the frequency. The scanner locks out the frequency, then continues searching.

#### Notes:

- The scanner does not store locked out frequencies during a search.

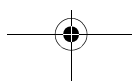



- You can lock out as many as 50 frequencies in each bank. If you try to lock out more, **Memory full!** appears.
- If you lock out all frequencies in one search bank and only this search bank is activated, **Search up... All ranges locked out!** appears and the scanner does not search.



### Reviewing Locked-Out Frequencies

Follow these steps to review the frequencies within a search bank that you locked out.

1. Press **SEARCH** to start search.
2. Press **FUNC** then **L/OUT**. The locked-out frequency appears. If the search bank has no locked-out frequencies, **L/O list is empty.** appears.
3. Press **FUNC** then **▲** to select a search bank and begin the search for locked out channels within that bank.

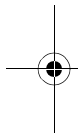

Each time you press **▲**, the scanner displays all locked-out frequencies within a bank.

**Locked-out**

SL-1...D...+PL  
155.5800 MHz

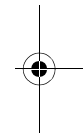

### Clearing a Locked-Out Frequency

To clear a locked-out frequency, select that frequency in order to use the locked-out frequencies review function, then press **CL**.

The frequency is unlocked and **Unlocked** appears for about 2 seconds. Then the next locked-out frequency appears. If all locked out frequencies are cleared within a bank, **L/O list is empty.** appears.

### Clearing All Lock Out Frequencies in a Search Bank

1. Press **SEARCH**.
2. Turn on only one search bank, the one in which you want to clear all locked-out frequencies.

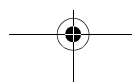



3. Turn **SQUELCH** fully counterclockwise until the indicator points to **MIN**.
4. Press **FUNC** then **4. Confirm list clear? 1=YES Press other key for NO.** appears. Press **1** to clear all lock-out frequencies and **List cleared** appears for about 2 seconds. Press any key other than **1**, to cancel clear.

**Note:** You cannot clear all lock-out frequencies if all frequencies in the selected bank are locked out.

5. Turn **SQUELCH** clockwise and leave it set to a point just until the hissing sound stops.

## PRIORITY

With the priority feature, you can scan through programmed channels and still not miss an important or interesting call on a specific channel. When a channel is selected as the priority channel and priority is turned on, the scanner checks that channel every 2 seconds, and stays on the channel if there is activity until the activity stops.

The scanner is preset to select Channel 00 in Bank 8 as the priority channel. You can program a different channel as the priority channel. Also, you can program a weather channel as the priority channel.

### Notes:

- The priority feature does not operate while the scanner receives trunking frequencies.
- If you program a weather channel as the priority channel, the scanner stays in the priority channel only when the scanner detects the weather alert tone.

Follow these steps to program a channel as the priority channel.

1. Press **MANUAL**.
2. Use the number keys to enter the channel number you want to program as the priority channel. Then press **MANUAL** again.

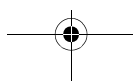



M008z••D•+FM  
146.8000 Pri  
Bank 0 Ch 08

3. Press **FUNC** then **PRI**. **Pri** appears to the right of the frequency.

**Note:** This scanner cannot set a channel as the priority channel if the channel's receive mode is **LTR**, **MOT**, or **ED**.

Follow these steps to program a weather channel as the priority channel.

1. Press **WX**.
2. Select the weather channel you want to program as the priority channel.
3. Press **FUNC** then **PRI**. **Pri** appears to the right of the frequency.

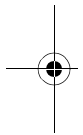

To turn on the priority feature, press **PRI** while scanning. **Priority ON** (or **Priority WX** if you set the priority to a weather channel) appears for about 3 seconds, then **P** appears. The scanner checks the priority channel every 2 seconds. It stays on the channel if there is activity (or if it detects a weather alert tone in Priority WX mode), **Pri** appears and **S** or **M** changes to **P**.

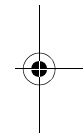

**Notes:**

- Priority WX is only for receiving a weather alert.
- When the scanner detects a 1050 Hz tone, Priority WX activates and you receive a weather alert.

To turn off the priority feature, press **PRI**. **Priority OFF** appears and **P** disappears.

**Notes:**

- If you program a weather frequency into the priority channel and the scanner detects a weather alert tone on that frequency, the scanner sounds the alert tone.

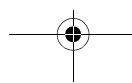



- The scanner always monitors the priority channel even if it is in a bank that is set to closed mode (see “Changing the Open/Closed Mode” on Page 58).



## CHANGING THE RECEIVE MODE

The scanner is preset to the most common AM or FM receive mode for each frequency range. The preset mode is correct in most cases. However, some amateur radio transmissions and trunked systems do not operate in the preset mode. If you try to listen to a transmission when the scanner is not set to the correct receive mode, the transmission might sound weak or distorted.

If you want to listen to private line or trunking transmissions in closed mode, you might have to change the receive mode.

To change the receive mode, repeatedly press **MODE**. The receive mode changes as follows:

Display	Description
<b>AM</b>	AM Mode
<b>FM</b>	FM Mode
<b>PL</b>	FM Mode, Private Line (with 67.0–254.1 Hz PL code)
<b>DL</b>	FM Mode, Digital Private Line (with 3-digit DPL code)
<b>LT</b>	FM Mode, LTR Trunking System (with 6-digit ID code)
<b>MO</b>	FM Mode, Motorola Trunking System (with a 4- or 5-digit ID code)
<b>ED</b>	FM Mode, EDACS Trunking System (with 4-digit ID code)

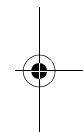
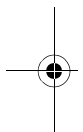

## CHANGING THE FREQUENCY STEP

The scanner searches at a preset frequency step for each frequency range. Press **STEP** to change the step increment when moving between frequencies of a

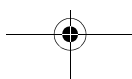



search band or follow these steps to change steps in a specific bank.



1. Press **SEARCH**.
2. Press **FUNC** then repeatedly press **▲** to select a bank.
3. Turn **SQUELCH** fully counterclockwise until the indicator points to **MIN**.
4. Press **STEP** continuously until you reach the desired step.
5. Turn **SQUELCH** clockwise and leave it set to a point just after the hissing sound stops.

These are the changeable frequency steps your scanner uses for each frequency range.

Range (MHz)	Search Step (kHz)
29.000-54.000	5, 10, 15, 20, 25, 30, 50, 100
108.000-136.9875	12.5, 25, 50, 100
137.000-174.000	5, 10, 15, 20, 25, 30, 50, 100
380.000-512.000	12.5, 25, 50, 100
806.000-823.9875	12.5, 25, 50, 100
849.000-868.9875	12.5, 25, 50, 100
894.000-960.000	12.5, 25, 50, 100

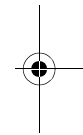
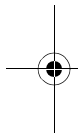

## USING THE ATTENUATOR

To reduce interference or noise caused by strong signals, you can reduce the scanner's sensitivity to these signals. Press **ATT** until **A** appears to reduce the scanner's sensitivity on the current channel.

**Note:** If you turn on this feature, the scanner might not receive weak signals.

To turn off the attenuator, press **ATT** again. **A** disappears.

This setting is stored for each channel.

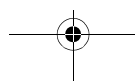



## USING THE DISPLAY BACKLIGHT

You can turn on the display's backlight for easy viewing in dimly lit areas. Press **LIT** to turn on the display light for 5 seconds. To turn off the light before it automatically turns off, press **LIT** again.



## TURNING THE KEY TONE ON AND OFF

Each time you press any of the scanner's keys, the scanner sounds a tone. Follow these steps to turn the scanner's key tone off or on.

1. If the scanner is on, turn **VOLUME OFF/MAX** counter-clockwise until it clicks to turn the scanner off.
2. Turn **VOLUME OFF/MAX** clockwise to turn the scanner on. **Welcome To Multi-System Trunking** appears.
3. While **Welcome To Multi-System Trunking** appears, press **1** to turn on the key tone or **2** to turn it off.

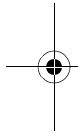

## USING THE KEYSLOCK

Once you program your scanner, you can protect it from accidental program changes by turning on the keylock feature. When the keypad is locked, the only controls that operate are **FUNC**, **↔ /LIT**, **SQUELCH**, and **VOLUME**.

**Note:** You cannot activate the keylock when in the middle of programming.

To turn on the keylock, press **FUNC** then **↔ /LIT**. **Keyboard Locked** appears for about 1 second. **Keyboard Locked** appears when you press any key after locking the keypad.

To turn off the keylock, press **FUNC** then **↔ /LIT**. The scanner beeps once and **Keyboard Unlocked** appears about 1 second.

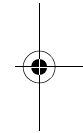

## CHANGING THE DISPLAY CONTRAST

1. Press **MANUAL**.

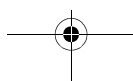



2. Press **FUNC** then **9**. Use **Up/Down keys** to set **contrast**. appears.
3. Press **▲** or **▼** to select the contrast.
4. Press **ENTER** to set the display contrast.



## **CLONING THE PROGRAMMED DATA FROM SCANNER TO SCANNER**

You can transfer the programmed data to and from another RadioShack Cat. No. 20-522A or Cat. No. 20-196 scanner using the supplied clone cable. To clone the data, follow these steps.

1. Turn on both scanners.
2. Connect the supplied clone cable to each scanner's **PC/IF** jack. **CLONE MODE UP to send, remove cable to exit** appears.
3. Press **▲**. **Confirm send data? 1=Yes Press other key for No.** appears.
4. Press **1** to send the data to the other unit or press any other key to cancel the operation.

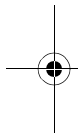

The scanner sends the data. To exit the clone mode, remove the cable.

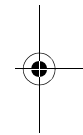

---

---

## **Trunking Operation**

The scanner tracks transmissions that use the Motorola<sup>®</sup> Type I and Type II (such as Smartnet and Privacy Plus) and hybrid analog trunking systems, plus GE/Ericsson (EDACS) and EF Johnson (LTR) type systems, which are extensively used in many communication systems.

Trunking systems allocate a few frequencies to many different users. When the mobile unit transmits a signal, one frequency is chosen from among the allocated frequencies in that trunking system. The user's **ID talk group** is sent with the signal.

To receive trunking signals, you must store all the trunking group frequencies in one bank (see "Storing Known Frequencies into Channels" on Page 30) and input ID

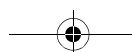



codes in the ID memory (see “Storing Talk Group IDs” on Page 55). To listen to the transmission, the mode of the programmed channel must be the same as that of the trunking channel (LT, MO, or ED).



When an ID code is received, the ID list for the bank is searched, and if found, the text name stored for the ID appears. If not found, scanning resumes immediately unless the bank is in open trunking mode.

**Note:** There might be more than one talk group transmitting at a time in some Motorola trunking systems. If you set the scanner to manually tune in Motorola trunking mode, you will hear the talk group on that channel, but the display will alternate between all active IDs.

Trunking group frequencies are included in the supplied *Police Call Trunking Guide*. Frequency fleet map and talk group information is also widely available on the Internet, at [www.trunkscanner.com](http://www.trunkscanner.com) for example.

## UNDERSTANDING TRUNKING

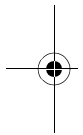

In the past, groups that transmit frequently, such as police departments, could transmit on only a few frequencies. This resulted in heavy traffic and often required 2-way radio users to wait for a specific frequency to clear before transmitting. Trunked systems allow more groups of 2-way radio users to use fewer frequencies. Instead of selecting a specific frequency to transmit on, a trunked system chooses one of several frequencies when the 2-way radio user transmits. The system automatically transmits the call on that frequency, and also sends a code that identifies that 2-way radio user’s transmission on a control channel.

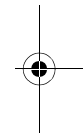

This scanner lets you easily hear both the call and response transmissions for that 2-way radio user and therefore follow the conversation. For EDACS and Motorola (above 806 MHz range), the scanner monitors the control channel between each transmission to identify talk groups. For some Motorola (under 512 MHz range) and LTR systems, the scanner uses the subaudible data sent with each transmission to identify talk groups.

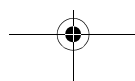



## SETTING SQUELCH FOR THE TRUNKING MODE



Your scanner automatically mutes the audio during trunk scanning when it decodes control channel data. However, we recommend you turn **SQUELCH** clockwise and leave it set to a point just after the hissing sound stops. This lets the scanner quickly acquire the data channel.

## PROGRAMMING TRUNKING FREQUENCIES

You program trunking frequencies just like non-trunked frequencies, except that you must store the appropriate mode (MO, ED, or LT) with each frequency.

### Notes:

- You can store only one trunked EDACS and Motorola channel in a bank. You can, however, mix LTR and conventional channels in a bank.
- If you are scanning UHF trunking frequencies under the 512 MHz range using subaudible data and are not using a base frequency and offset, lock out all data channels. See "Programming Motorola Trunking Systems (UHF-Lo)" on Page 51 and "Locking Out Channels or Frequencies" on Page 41. Turn off the scanner to remove the lockouts.
- If you are programming trunked frequencies for Motorola Type I and hybrid systems, you must first program the fleet map (see "Programming Fleet Maps" on Page 53).
- You must store frequencies using the subaudible trunking method in banks, mode by mode.

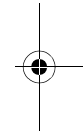
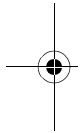

Follow these steps to program trunked frequencies.

1. Press **PGM** and select the bank, then press **TRUNK** to enter the ID program mode.
2. Repeatedly press **MODE** to select **LT** for EF Johnson, **MO** for Motorola, or **ED** for the EDACS (GE/Ericsson) system to scan. This sets the talk group ID decoding method to be used for the bank.

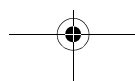



**Notes:**

- If you select -- instead of **LT**, **MO**, or **ED**, the scanner does not scan trunked frequencies. Instead, you see:

I000<.....--  
 Not trunked.  
 Press mode.

- If you programmed a Motorola Type I or Hybrid system, see “Programming Fleet Maps” on Page 53.

3. Press **PGM** to enter the program mode.
4. Store the trunking frequencies into subsequent channels in the same bank (see “Storing Known Frequencies into Channels” on Page 30).
5. Repeatedly press **MODE** to select the trunking mode — **LT** for EF Johnson, **MO** for Motorola, or **ED** for the EDACS (GE/Ericsson) system.
6. Press **SCAN**. If the scanner’s receive mode matches the ID mode, **T** appears and the scanner scans the frequencies.

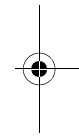
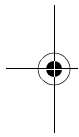

**Programming Motorola Trunking Systems (UHF-Lo)**

You can program the scanner to receive transmissions in the UHF-Lo band (380–512 MHz) of the Motorola trunking system. You can receive these transmissions by:

- Checking the trunking system’s control channel. You must program the system’s base frequency and offset frequency to do this.
- Decoding the subaudible data transmitted with the signals. When you do this, the scanner might detect wrong IDs but you can easily receive trunking frequencies without programming the base and offset frequencies.

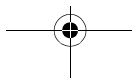



**Notes:**

- Base and offset frequencies vary for each type of trunking system. You can get information about these frequencies for the trunking system you want to scan using *www.trunkscanner.com*, other Internet sources, or locally-published guidebooks.
- The scanner automatically decodes subaudible data it receives in the VHF band.
- If you try to enter an offset frequency in the VHF and UHF-Hi bands (137–174 and 806–960 MHz), the scanner will ignore the entry.

Follow these steps to program Motorola trunking frequencies in the UHF-Lo band.

1. Select the bank, then press **PGM** to enter the program mode.
2. Store the base frequency into channel 00 of the bank you selected, then store the trunking frequencies into subsequent channels in the same bank.
3. Press **TRUNK** then repeatedly press **MODE** to select **MO** (Motorola).
4. Press **FUNC** then **9**. **12.5 kHz** (the default offset frequency) appears.

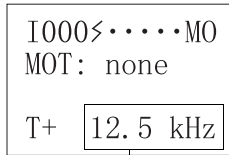
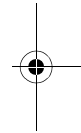
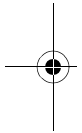

**Offset Frequency**

5. Repeatedly press **FUNC** then **9** to select the offset frequency you want (**12.5 kHz**, **25.0 kHz**, or **50 kHz**).

**Note:** Offset frequencies above 50 kHz do not appear and are used only for subaudible decoding mode.

6. Program the trunking frequencies (see “Programming Trunking Frequencies” on Page 50).



## PROGRAMMING FLEET MAPS

You must set the fleet map if you want to receive a Motorola Type I system. Fleet maps are included along with other information about Motorola Type I systems at [www.trunkscanner.com](http://www.trunkscanner.com).

Follow these steps to program a fleet map.

1. Press **PGM** then **TRUNK**.
2. For each bank you want to program, repeatedly press **FUNC**, **▲**, or **▼** to select the bank.
3. Press **FUNC**.
4. Press **8**. The following display appears:

Block 0 size  
code. Use 15  
for type II.  
S-00

5. Enter the size code supplied with the Type I system information, referring to the instruction that appears on the display. If the information was not supplied, try the following common fleet maps.

B L O C K	Size Code							
	1	2	3	4	5	6	7	8
0	S11	S4	S4	S12	S4	S3	S10	S1
1	S11	S4	S4	—	S4	S10	S10	S1
2	S11	S4	S4	S4	S12	S4	S11	S2
3	S11	S4	S4	S4	—	S4	S4	S2
4	S11	S4	S4	S4	S4	S12	S4	S3
5	S11	S4	S4	S4	S4	—	S4	S3
6	S11	S4	S12	S4	S4	S12	S4	S4
7	S11	S4	—	S4	S4	—	S4	S4

B L O C K	Size Code							
	9	10	11	12	13	14	15	16
0	S4	S0	S4	S0	S3	S4	S4	S3
1	S4	S0	S0	S0	S3	S3	S4	S10
2	S0	S0	S0	S0	S11	S10	S4	S10
3	S0	S0	S0	S0	S4	S4	S11	S11
4	S0	S0	S0	S0	S4	S4	S11	S0
5	S0	S0	S0	S0	S0	S4	S0	S0
6	S0	S4	S0	S0	S0	S12	S12	S12
7	S0	S4	S0	S4	S0	—	—	—

6. Press **ENTER** for each entry. If you make a mistake, press **CL** and enter the correct size code.

**Note:** The default setting of the bank is for Motorola Type II. However, if you set Type I and you want to return to Type II, enter **15** at Step 5.

7. To confirm the input, repeat Steps 1–5 and press **ENTER**. Each time you press **ENTER**, you confirm the size code. If you find an error, press **CL** and begin again at Step 1.
8. Press **SCAN** to start scanning.

## TALK GROUP IDS

You can program up to 100 talk group IDs in each bank. When the scanner stops on a transmission in the LTR, Motorola, or EDACS mode, it checks to see if the ID has been stored. In the closed mode, the scanner only stops on the transmission and displays its text tag if you have stored and not locked out the ID. In the open mode, the scanner always stops on a transmission, but it displays the ID's text tag if you have stored the ID.



## Storing Talk Group IDs

To store a talk group ID when scanning, press **TRUNK** when the scanner stops on a transmission. The bottom line changes to **ID#XXXX**, indicating that the ID is stored.

**Note:** When you try to store more than 100 talk group IDs in a bank, **Memory full!** appears. Clear some talk group IDs in order to store new ones (see "Clearing Talk Group IDs" on Page 56).

Follow these steps to manually store talk group IDs or to edit a stored ID.

1. Press **PGM**.
  2. Press **TRUNK**.
  3. To select the bank where you want to store the ID, press **FUNC** then **▲** or **▼**.
  4. Press **MODE** to select **LT**, **MO**, or **ED**.
  5. Enter the talk group ID and press **ENTER**. If necessary, use the decimal point for a hyphen.
- Note:** If you made a mistake in Step 4, **Invalid ID.** appears and the scanner beeps when you press **ENTER**. Start again at Step 3.
6. Press **TEXT** and enter the text tag for the ID, then press **ENTER**.
  7. To store the next ID memory in sequence, press **▲** and repeat Steps 4 and 5 to enter more IDs.
  8. Press **SCAN** to start scanning.

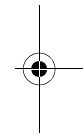
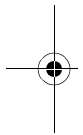

## Talk Group ID Hold

You can set your scanner to follow a trunking signal that you want to track during scanning. Hold down **TRUNK** for more than 2 seconds. **ID hold ON.** appears.

S2084.0D+M0
850.6625 MHz
Bank 2 Ch 08
ID hold ON.

To release ID hold, press **SCAN** or **TRUNK**.





## Locking Out Talk Group IDs

**Note:** You can only lock out talk group IDs when the scanner is in the closed mode (see “Open and Closed Modes” on Page 57).

1. Press **PGM**.
2. Press **TRUNK**.
3. Press **FUNC**, **▲** or **▼** to move the desired bank.
4. Press **▲** or **▼** to select the ID memory.
5. Press **L/OUT** to lock out the ID. **L** appears.
6. To remove the lockout from a trunking ID, manually select the ID memory, and press **L/OUT** until **L** disappears.

## Reviewing Locked-Out Talk Group IDs

**Note:** You cannot clear all lockouts from a talk group at the same time.

1. Press **PGM** then **TRUNK**.
2. Press **FUNC** then **L/OUT**. The locked out ID appears. If the ID memory bank has no locked out ID, you hear the low beep tone.
3. Press **FUNC** then **▲** or **▼** to select a search bank. Or, just press **▲** or **▼** to search for any locked out IDs in a bank.

## Clearing Talk Group IDs

1. Press **PGM** then **TRUNK**.
2. Press **FUNC**, **▲** or **▼** to select ID memory.
3. Press **FUNC** then **CL**.

## Clearing All Talk Group IDs in One Bank

You can clear all talk group IDs within a bank. This lets you quickly delete all talk group IDs from a bank (for example, if you want to use the bank to store a different set of talk group IDs).

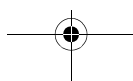



1. Press **PGM**.
2. Press **TRUNK** to enter a talk group ID memory mode.
3. Select a talk group ID bank using **FUNC**, **▲** or **▼**.
4. Press **FUNC** then **3**. **Confirm list clear ?1=YES Press other key for NO.** appears.
5. Press **1** to clear the all talk group IDs within a bank. **Please Wait** then **List Cleared** appears.

**Note:** To cancel the deletion, press any key except **1**. The scanner returns to the talk group ID memory mode.

## OPEN AND CLOSED MODES

When set to the open mode, the scanner only uses the ID list to look up ID text tags and stops on any ID code.

When set to the closed mode, the scanner stops only on signals that have an ID code which is found in the ID list for the bank.

**Note:** When you select a channel manually, any transmission opens squelch, regardless of the current mode.

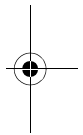
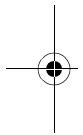

### Closed Mode

S005~~z~~·D·-FM  
 146.5000 MHz  
 Bank 0 Ch 05

The open or closed mode is set in each channel storage bank. **+** or **-** appears under the channel storage bank's number while scanning. Or, the status display shows the OPEN/CLOSED mode at the top line while the scanner is in manual mode or receiving a signal during scanning.

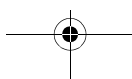



When no ID code is programmed into the scanner, it receives the signal in PL, DPL, LTR, MOT, or ED mode.



Mode	Open	Closed
PL and DPL	Accepts any PL and DPL.	Accepts only the PL or DPL stored in the channel.
MOT/ED/LTR	Stops on any transmission. If the ID is stored, displays the text tag. Otherwise, displays the talk group ID.	Only stops on a transmission if the ID is stored. Displays the text tag.

### Changing the Open/Closed Mode

1. Press **MANUAL**.
2. Press **FUNC** then **▲** or **▼** to select the channel storage bank.
3. Press **FUNC** then **2**. **Bank OPEN** or **Bank CLOSED** appears. After that message disappears, the 10th digit on the top line of the display changes from **+** to **-** or vice versa.
4. Repeat Steps 2–3 for each bank.

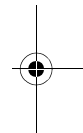
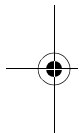

## **A General Guide to Scanning**

Reception of the frequencies covered by your scanner is mainly “line-of-sight.” That means you usually cannot hear stations that are beyond the horizon.

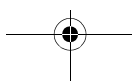



## GUIDE TO FREQUENCIES



### US Weather Frequencies

162.400	162.425	162.450	162.475
162.500	162.525	162.550	

### Ham Radio Frequencies

Ham radio operators often transmit emergency information when other means of communication break down. The chart below shows the frequencies the scanner receives that ham radio operators normally use:

Wavelength	Frequencies (MHz)
10-Meter	29.000–29.700
6-Meter	50.000–54.000
2-Meter	144.000–148.000
70-cm	420.000–450.000
33-cm	902.000–928.000

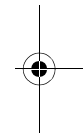
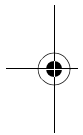

### Birdie Frequencies

Every scanner has birdie frequencies. Birdies are signals created inside the scanner's receiver. These operating frequencies might interfere with transmissions on the same frequencies. If you program one of these frequencies, you hear only noise on that frequency. If the interference is not severe, you might be able to turn **SQUELCH** clockwise to cut out the birdie.

This scanner's birdie frequencies (in MHz) are:

29.0000	147.7650	415.3375	475.2375
31.9500	150.1500	419.3375	479.2375
32.1000	151.7600	423.3250	483.2250
35.9400	155.7500	427.3125	487.2250
38.4000	159.7450	429.0500	491.2125

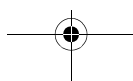



42.9750	163.7400	431.3125	495.2125
43.9300	167.7300	435.3000	499.2000
47.9250	171.5500	439.3000	503.2000
49.9200	383.3875	443.2875	507.1875
51.9150	387.3750	447.2875	511.1875
54.0000	391.3750	451.2750	814.7000
108.0000	395.3750	455.2750	818.0125
115.8125	399.3625	459.2625	820.1125
123.8000	403.3625	463.2625	823.2625
131.7875	407.3500	467.2500	944.0500
139.7750	411.3500	471.2500	960.0000
143.7700			

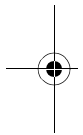

To find the birdies in your scanner, begin by disconnecting the antenna and moving it away from the scanner. Make sure that no other nearby radio or TV sets are turned on near the scanner. Use the search function and scan every frequency range from its lowest frequency to the highest. Occasionally, the searching will stop as if it had found a signal, often without any sound. This is a birdie. Make a list of all the birdies in your scanner for future reference.

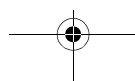
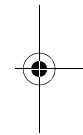



## GUIDE TO THE ACTION BANDS

### Typical Band Usage

#### VHF Band

Low Range	29.00–50.00 MHz
6-Meter Amateur	50.00–54.00 MHz
U.S. Government	137.00–144.00 MHz
2-Meter Amateur	144.000–148.00 MHz
High Range	148.00–174.00 MHz

#### UHF Band

Military Aircraft	380.00–384.00 MHz
U.S. Government	406.00–420.00 MHz
70-cm Amateur	420.00–450.00 MHz
Low Range	450.00–470.00 MHz
FM-TV Audio Broadcast, Wide Band	470.000–512.00 MHz
800 Band Law Enforcement	806.00–824.00 MHz
Conventional Systems	851.00–856.00 MHz
Conventional/Trunked Systems	856.00–861.00MHz
Public Safety	866.00–869.00 MHz
Trunked Private/General	894.00–960.00 MHz

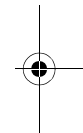
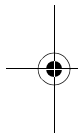

### Primary Usage

As a general rule, most of the radio activity is concentrated on the following frequencies:

#### VHF Band

Activities	Frequencies
Government, Police, and Fire	153.785–155.980 MHz
Emergency Services	158.730–159.460 MHz
Railroad	160.000–161.900 MHz

#### UHF Band

Activities	Frequencies
Land-Mobile "Paired" Frequencies	450.000–470.000 MHz
Base Stations	451.025–454.950 MHz
Mobile Units	456.025–459.950 MHz
Repeater Units	460.025–464.975 MHz
Control Stations	465.025–469.975 MHz

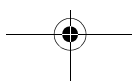



**Note:** Remote control stations and mobile units operate at 5 MHz higher than their associated base stations and relay repeater units.

## BAND ALLOCATION

To help decide which frequency ranges to scan, use the following listing of the typical services that use the frequencies your scanner receives. These frequencies are subject to change, and might vary from area to area. For a more complete listing, refer to *Police Call Radio Guide including Fire and Emergency Services*, available at your local RadioShack store.

### Abbreviations Services

AIR	Aircraft
BIFC	Boise (ID) Interagency Fire Cache
BUS	Business
CAP	Civil Air Patrol
CCA	Common Carrier
CSB	Conventional Systems
CTSB	Conventional/Trunked Systems
FIRE	Fire Department
HAM	Amateur (Ham) Radio
GOVT	Federal Government
GMR	General Mobile Radio
GTR	General Trunked
IND	Industrial Services (Manufacturing, Construction, Farming and Forest Products)
MAR	Military Amateur Radio
MARI	Maritime Limited Coast (Coast Guard, Marine Telephone, Shipboard Radio and Private Stations)
MARS	Military Affiliate Radio System
MED	Emergency/Medical Services
MIL	U.S. Military
MOV	Motion Picture/Video Industry
NEW	New Mobile Narrow
NEWS	Relay Press (Newspaper Reporters)
OIL	Oil/Petroleum Industry
POL	Police Department
PUB	Public Services (Public Safety, Local Government and Forestry Conservation)
PSB	Public Safety
PTR	Private Trunked
ROAD	Road & Highway Maintenance
RTV	Radio/TV Remote Broadcast Pickup
TAXI	Taxi Services
TELB	Mobile Telephone
TELM	Telephone Maintenance
TOW	Tow Trucks
TRAN	Transportation Services (Trucks, Tow Trucks, Buses, Railroad, Other)
TSB	Trunked Systems
TVn	FM-TV Audio Broadcast
USXX	Government Classified
UTIL	Power & Water Utilities

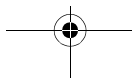



WTNR ..... Weather



**HIGH FREQUENCY (HF)**

**10-Meter Amateur Band**

29.000–29.700 ..... HAM

**VERY HIGH FREQUENCY (VHF)**

**VHF Low Band—(29–50 MHz—in 5 kHz steps)**

29.900–30.550 ..... GOVT, MIL  
 30.580–31.980 ..... IND, PUB  
 32.000–32.990 ..... GOVT, MIL  
 33.020–33.980 ..... BUS, IND, PUB  
 34.010–34.990 ..... GOVT, MIL  
 35.020–35.980 ..... BUS, PUB, IND, TELM  
 36.000–36.230 ..... GOVT, MIL  
 36.250 ..... Oil Spill Cleanup  
 36.270–36.990 ..... GOVT, MIL  
 37.020–37.980 ..... PUB, IND  
 38.000–39.000 ..... GOVT, MIL  
 39.020–39.980 ..... PUB  
 40.000–42.000 ..... GOVT, MIL, MARI  
 42.020–42.940 ..... POL  
 42.960–43.180 ..... IND  
 43.220–43.680 ..... TELM, IND, PUB  
 43.700–44.600 ..... TRAN  
 44.620–46.580 ..... POL, PUB  
 46.600–46.990 ..... GOVT  
 47.020–47.400 ..... PUB  
 47.420 ..... American Red Cross  
 47.440–49.580 ..... IND, PUB  
 49.610–49.990 ..... MIL

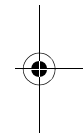
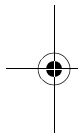

**6-Meter Amateur Band—(50–54 MHz)**

50.000–54.000 .....HAM

**Aircraft Band—(108–137 MHz)**

108.00–121.490 .....AIR  
 121.500 ..... AIR Emergency  
 121.510–136.975 ..... AIR

**U.S. Government Band (137–144 MHz)**

137.000–144.000 .....GOVT, MIL

**2-Meter Amateur Band (144–148 MHz)**

144.000–148.000 .....HAM

**VHF High Band (148–174 MHz)**

148.050–150.345 ..... CAP, MAR, MIL  
 150.775–150.790 ..... MED  
 150.815–150.980 ..... TOW, Oil Spill Cleanup  
 150.995–151.475 ..... ROAD, POL  
 151.490–151.955 ..... IND, BUS  
 151.985 ..... TELM  
 152.0075 .....MED

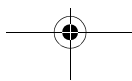



152.030–152.240	TEL
152.270–152.480	IND, TAXI, BUS
152.510–152.840	TEL
152.870–153.020	IND, MOV
153.035–153.725	IND, OIL, UTIL
153.740–154.445	PUB, FIRE
154.490–154.570	IND, BUS
154.585	Oil Spill Cleanup
154.600–154.625	BUS
154.655–156.240	MED, ROAD, POL, PUB
156.255–157.425	OIL, MARI
157.450	MED
157.470–157.515	TOW
157.530–157.725	IND, TAXI
157.740	BUS
157.770–158.100	TEL
158.130–158.460	BUS, IND, OIL, TELM, UTIL
158.490–158.700	TEL
158.730–159.465	POL, PUB, ROAD
159.480	OIL
159.495–161.565	TRAN
161.580–162.000	OIL, MARI, RTV
162.0125–162.350	GOVT, MIL, USXX
162.400–162.550	WTHR
162.5625–162.6375	GOVT, MIL, USXX
162.6625	MED
162.6875–163.225	GOVT, MIL, USXX
163.250	MED
163.275–166.225	GOVT, MIL, USXX
166.250	GOVT, RTV, FIRE
166.275–169.400	GOVT, BIFC
169.445–169.505	Wireless Mikes, GOVT
169.550–169.9875	GOVT, MIL, USXX
170.000–170.150	BIFC, GOVT, RTV, FIRE
170.175–170.225	GOVT
170.245–170.305	Wireless Mikes
170.350–170.400	GOVT, MIL
170.425–170.450	BIFC
170.475	PUB
170.4875–173.175	GOVT, PUB, Wireless Mikes
173.225–173.5375	MOV, NEWS, UTIL, MIL
173.5625–173.5875	MIL, Medical/Crash Crews
173.600–173.9875	GOVT



**ULTRA HIGH FREQUENCY (UHF)**

**U. S. Government Band (406–420 MHz)**

406.125–419.975 . . . . . GOVT, USXX

**70-cm Amateur Band (420–450 MHz)**

420.000–450.000 . . . . . HAM

**Low Band (450–470 MHz)**

450.050–450.925	RTV
451.025–452.025	IND, OIL, TELM, UTIL
452.0375–453.00	IND, TAXI, TRAN TOW, NEWS
453.0125–454.000	PUB, OIL
454.025–454.975	TEL
455.050–455.925	RTV
457.525–457.600	BUS
458.025–458.175	MED





460.0125–460.6375	FIRE, POL, PUB
460.650–462.175	BUS
462.1875–462.450	BUS, IND
462.4625–462.525	IND, OIL, TELM, UTIL
462.550–462.925	GMR, BUS
462.9375–463.1875	MED
463.200–467.925	BUS



**FM-TV Audio Broadcast, UHF Wide Band (470–512 MHz)  
(Channels 14 through 69 in 6 MHz steps)**

475.750	Channel 14
481.750	Channel 15
487.750	Channel 16
493.750	Channel 17
499.750	Channel 18
505.750	Channel 19
511.750	Channel 20

**Note:** Some cities use the 470–512 MHz band for land/mobile service.

**Conventional Systems Band – Locally Assigned**

851.0125–855.9875	CSB
-------------------	-----

**Conventional/Trunked Systems Band – Locally Assigned**

856.0125–860.9875	CTSB
-------------------	------

**Trunked Systems Band – Locally Assigned**

861.0125–865.9875	TSB
-------------------	-----

**Public Safety Band – Locally Assigned**

866.0125–868.9875	PSB
-------------------	-----

**33-Centimeter Amateur Band (902–928 MHz)**

902.000–928.000	HAM
-----------------	-----

**Private Trunked Band**

935.0125–939.9875	PTR
-------------------	-----

**General Trunked Band**

940.0125–940.9875	GTR
-------------------	-----

**FREQUENCY CONVERSION**

The tuning location of a station can be expressed in frequency (kHz or MHz) or in wavelength (meters). The following information can help you make the necessary conversions.

1 MHz (million) = 1,000 kHz (thousand)

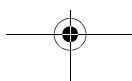



To convert MHz to kHz, multiply the number of megahertz by 1,000:

$$30.62 \text{ (MHz)} \times 1000 = 30,620 \text{ kHz}$$

To convert from kHz to MHz, divide the number of kilohertz by 1,000:

$$127,800 \text{ (kHz)} \div 1000 = 127.8 \text{ MHz}$$

To convert MHz to meters, divide 300 by the number of megahertz:

$$300 \div 50 \text{ MHz} = 6 \text{ meters}$$



## **Troubleshooting**

If you have problems with your scanner, here are some suggestions that might help you eliminate the problem. If they do not, take your scanner to your local RadioShack store for assistance.

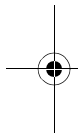

Problem	Possible Cause	Remedy
Scanner is on but will not scan.	<b>SQUELCH</b> is not adjusted correctly.	Turn <b>SQUELCH</b> clockwise. See "Turning on the Scanner and Setting Squelch" on Page 29.
Poor or no reception.	An antenna is not connected or connected incorrectly.	Make sure an antenna is connected to the scanner.
	Programmed frequencies are the same as birdie frequencies.	Avoid programming birdie frequencies or only select them manually. See "Birdie Frequencies" on Page 59.
In the scan mode, the scanner locks on frequencies that have an unclear transmission.	Stored frequencies are the same as "birdie" frequencies.	Avoid storing birdie frequencies or only select them manually. See "Birdie Frequencies" on Page 59.

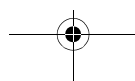
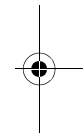

Problem	Possible Cause	Remedy
Scanner is totally inoperative.	No power.	Check the batteries or make sure the AC adapter or DC adapter is connected properly.
		Recharge the rechargeable batteries or replace the non-rechargeable batteries.
	The AC adapter or DC adapter is not connected.	Be sure the adapter's barrel plug is fully plugged into the <b>PWR DC 9V</b> jack.
	The batteries may be improperly installed.	Make sure the batteries are properly installed according to polarity markings on the battery holder.
Keypad does not work.	Keylock is turned on.	Turn off keylock.
Keys do not work or display changes.	Undetermined error.	Turn the scanner off then on again, or reset the scanner. See "Resetting/Initializing the Scanner."

## RESETTING/INITIALIZING THE SCANNER

If the scanner's display locks up or does not work properly after you connect a power source, you might need to reset or initialize it.

**Important:** If you have problems with the scanner, first try to reset it to retain all memory. If that does not work, you can initialize the scanner; however, initializing clears all information stored in the scanner's memory.

### Resetting the Scanner

1. Turn off the scanner, then turn it on again.

2. Insert a pointed object, such as a straightened paper clip, into the reset opening on the side of the scanner. Then gently press and release the reset button inside the opening and the backlight lights.

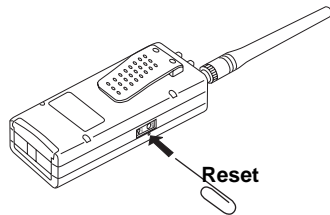

**Note:** Pressing **RESET** does not clear the scanner's memory.

### Initializing the Scanner

**Important:** This procedure clears all information you stored in the scanner's memory. Initialize the scanner only when you are sure the scanner is not working properly.

1. Turn off the scanner, then turn it on again. **Welcome To Multi-System Trunking** appears.
2. Press **0** then **1** while **Welcome To Multi-System Trunking** appears. **Initializing Please Wait.** appears for about 25 seconds.

**Note:** Do not turn off the scanner until the initialization is complete and **Welcome To Multi-System Trunking** appears again.

---

---

## Care

To enjoy your RadioShack Handheld Scanner for a long time:

- Keep the scanner dry. If it gets wet, wipe it dry immediately.
- Use and store the scanner only in normal temperature environments.



- Handle the scanner gently and carefully. Do not drop it.
- Keep the scanner away from dust and dirt.
- Wipe the scanner with a damp cloth occasionally to keep it looking new.



Modifying or tampering with the scanner's internal components can cause a malfunction and might invalidate its warranty and void your FCC authorization to operate it. If your scanner is not performing as it should, take it to your local RadioShack store for assistance.

## Specifications

### Frequency Coverage:

Ham .....	29–30 MHz (in 5 kHz steps)
VHF Lo .....	30–50 MHz (in 5 kHz steps)
Ham .....	50–54 MHz (in 5 kHz steps)
Aircraft .....	108–136.9875 MHz (in 12.5 kHz steps)
Government .....	137–144 MHz (in 5 kHz steps)
Ham .....	144–148 MHz (in 5 kHz steps)
VHF Hi .....	148–174 MHz (in 5 kHz steps)
Ham/Government .....	380–450 MHz (in 12.5 kHz steps)
UHF Lo .....	450–470 MHz (in 12.5 kHz steps)
UHF T .....	470–512 MHz (in 12.5 kHz steps)
UHF Hi .....	806–823.9875 MHz (in 12.5 kHz steps)
	849–868.9875 MHz (in 12.5 kHz steps)
	894–960 MHz (in 12.5 kHz steps)

Channels of Operation ..... 500  
(50 Channels x 10 Banks, 1000 Trunking ID Memories)

Number of Banks ..... 10

### Sensitivity (20dB S/N):

#### FM:

29–54 MHz .....	0.3 $\mu$ V
108–136.9875 MHz .....	0.3 $\mu$ V
137–174 MHz .....	0.5 $\mu$ V
380–512 MHz .....	0.5 $\mu$ V

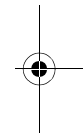
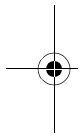



806–960 MHz ..... 0.7  $\mu$ V

AM:

29–54 MHz ..... 1  $\mu$ V  
 108–136.9875 MHz ..... 1  $\mu$ V  
 137–174 MHz ..... 1.5  $\mu$ V  
 380–512 MHz ..... 2  $\mu$ V  
 806–960 MHz ..... 2  $\mu$ V

Selectivity:

–6 dB .....  $\pm$ 10 kHz  
 –50 dB .....  $\pm$ 18 kHz

Spurious Rejection (at 154 MHz FM) ..... 40 dB

Scanning Rate ..... Up to 25 Channels per Second

Search Rate ..... Up to 50 Steps per second

Delay Time ..... 2 seconds

Intermediate Frequencies (IF):

1st ..... 257.5 MHz  
 2nd ..... 21.4 MHz  
 3rd ..... 455 kHz

Priority Sampling ..... 2 seconds

Operating Temperature ..... 14°–140°F  
 (–10°–60°C)



IF Rejection:

257.5 MHz at 154 MHz ..... 60 dB  
 21.4 MHz at 154 MHz ..... 100 dB

Squelch Sensitivity:

Threshold (FM and AM) ..... 0.5  $\mu$ V  
 Tight (FM) ..... 25 dB  
 Tight (AM) ..... 20 dB

Antenna Impedance ..... 50 Ohms

Audio Output Power (10% THD) ..... 240 mW

Built-in Speaker ..... 1<sup>3</sup>/<sub>8</sub> Inches  
 (36 mm)  
 (8-Ohm, Dynamic Type)

Power Requirements:

9V DC  
 6 AA Alkaline Batteries  
 or 6 AA Rechargeable Ni-Cd Batteries

Current Drain (Squelched) ..... 90 mA





Dimensions (HWD) .....  $6\frac{1}{4} \times 2\frac{3}{8} \times 1\frac{3}{4}$  Inches  
(160 × 61 × 45 mm)



Weight (without antenna and batteries) ..... 9.9 oz  
(280 g)

Specifications are typical; individual units might vary.  
Specifications are subject to change and improvement  
without notice.

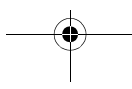
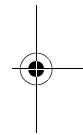
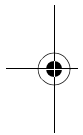

### Limited One-Year Warranty

This product is warranted by RadioShack against manufacturing defects in material and workmanship under normal use for one (1) year from the date of purchase from RadioShack company-owned stores and authorized RadioShack franchisees and dealers. EXCEPT AS PROVIDED HEREIN, RadioShack MAKES NO EXPRESS WARRANTIES AND ANY IMPLIED WARRANTIES, INCLUDING THOSE OF MERCHANTABILITY AND FITNESS FOR A PARTICULAR PURPOSE, ARE LIMITED IN DURATION TO THE DURATION OF THE WRITTEN LIMITED WARRANTIES CONTAINED HEREIN. EXCEPT AS PROVIDED HEREIN, RadioShack SHALL HAVE NO LIABILITY OR RESPONSIBILITY TO CUSTOMER OR ANY OTHER PERSON OR ENTITY WITH RESPECT TO ANY LIABILITY, LOSS OR DAMAGE CAUSED DIRECTLY OR INDIRECTLY BY USE OR PERFORMANCE OF THE PRODUCT OR ARISING OUT OF ANY BREACH OF THIS WARRANTY, INCLUDING, BUT NOT LIMITED TO, ANY DAMAGES RESULTING FROM INCONVENIENCE, LOSS OF TIME, DATA, PROPERTY, REVENUE, OR PROFIT OR ANY INDIRECT, SPECIAL, INCIDENTAL, OR CONSEQUENTIAL DAMAGES, EVEN IF RadioShack HAS BEEN ADVISED OF THE POSSIBILITY OF SUCH DAMAGES.

Some states do not allow limitations on how long an implied warranty lasts or the exclusion or limitation of incidental or consequential damages, so the above limitations or exclusions may not apply to you.

In the event of a product defect during the warranty period, take the product and the RadioShack sales receipt as proof of purchase date to any RadioShack store. RadioShack will, at its option, unless otherwise provided by law: (a) correct the defect by product repair without charge for parts and labor; (b) replace the product with one of the same or similar design; or (c) refund the purchase price. All replaced parts and products, and products on which a refund is made, become the property of RadioShack. New or reconditioned parts and products may be used in the performance of warranty service. Repaired or replaced parts and products are warranted for the remainder of the original warranty period. You will be charged for repair or replacement of the product made after the expiration of the warranty period.

This warranty does not cover: (a) damage or failure caused by or attributable to acts of God, abuse, accident, misuse, improper or abnormal usage, failure to follow instructions, improper installation or maintenance, alteration, lightning or other incidence of excess voltage or current; (b) any repairs other than those provided by a RadioShack Authorized Service Facility; (c) consumables such as fuses or batteries; (d) cosmetic damage; (e) transportation, shipping or insurance costs; or (f) costs of product removal, installation, set-up service adjustment or reinstallation.

This warranty gives you specific legal rights, and you may also have other rights which vary from state to state.

RadioShack Customer Relations, 200 Taylor Street,  
6th Floor, Fort Worth, TX 76102

*We Service What We Sell*

12/99

RadioShack  
A Division of  
Tandy Corporation  
Fort Worth, Texas 76102

20-522 **B**  
GE-99D-3314B  
06A00  
Printed in China