



Scanning - Shortwave - Ham Radio - Equipment  
Internet Streaming - Computers - Antique Radio

# Monitoring Times

A Publication of Grove Enterprises

Volume 31, No. 9  
September 2012  
U.S. \$6.95  
Can. \$6.95  
Printed in the  
United States

## Amateur Radio in the Classroom



### In this issue:

- W9GRS: From Room 104 to the World!
- KC4WQ: Train Your Replacement
- School Club Roundup 2012
- MT Reviews: Degen DE321





# MTXpress

THE Magazine for every radio enthusiast is now fully digital!

FULL COLOR!



**Portable Ham Station in a Briefcase**  
By Bob Hutchins K0JZE  
(Photos by author unless otherwise noted)

**The Case for Briefcases**  
The case for your portable ham station is a critical component of your setup. It needs to be durable, lightweight, and easy to carry. The case should also have a secure locking mechanism to protect your equipment from theft or damage. Many cases are made of heavy-duty plastic or metal, and some have built-in handles and straps for easy carrying. The case should also have a secure locking mechanism to protect your equipment from theft or damage. Many cases are made of heavy-duty plastic or metal, and some have built-in handles and straps for easy carrying.

**Choosing the Right Radio**  
When choosing a portable ham radio, there are several factors to consider. The first is the power output of the radio. Most portable radios have a power output of 5 to 10 watts. The next factor to consider is the frequency range of the radio. Most portable radios are designed to operate in the 1.8 to 30 MHz range. The final factor to consider is the size and weight of the radio. A smaller, lighter radio is easier to carry, but it may not have as many features as a larger, heavier radio.

**The Other Stuff**  
In addition to your radio and case, you will need several other items to make your portable ham station complete. These include a power source, such as a battery or a power pack, and a microphone. You will also need a headset if you plan to use the radio for extended periods of time. Finally, you will need a good antenna for your radio. A good antenna can make a big difference in the range and quality of your communications.

**Headphones for the QRP**  
Headphones are an essential part of any ham station. They allow you to hear the signals you are transmitting and receiving. For QRP operators, headphones are especially important because they allow you to hear the signals more clearly and accurately. There are many different types of headphones available, and you should choose one that is comfortable and durable. Some headphones are designed specifically for use with ham radios, and they have a high impedance and a wide frequency response. Other headphones are designed for general use, and they may not be as well-suited for ham radio use.

**A Choice of Antennas**  
Antennas are another essential part of any ham station. They allow you to transmit and receive signals over long distances. There are many different types of antennas available, and you should choose one that is suitable for your operating frequency and power level. Some antennas are designed for use with QRP stations, and they are small and lightweight. Other antennas are designed for use with higher power stations, and they are larger and heavier. You should also consider the location of your antenna. A good antenna location can make a big difference in the range and quality of your communications.

ENTIRE LIBRARY ON ONE DEVICE!

Instead of a stack of paper copies, you can have your entire library of Monitoring Times on one device! Whether it's your desktop, notebook or tablet, every issue is right there at your fingertips!



INSTANT SEARCHES THROUGH THE ENTIRE MAGAZINE!

Only \$19.95 per year or only \$11 in addition to your print subscription!

✓ FAST DELIVERY

Every issue is delivered right to your computer every month. No need to wait for the Post Office any longer!

✓ PRINTABLE

If you want a hard copy of any or all of the issue, you can print it in high-resolution right to your own printer. It's even in full-color! (if you have a color-capable printer)

✓ AFFORDABLE

I have been a long time subscriber--off and on--since the early eighties when your format was newsprint. Through the years your staff and contributing writers have done a great job in producing some very informative articles. -Mark C.

Have downloaded my first copy of MTXpress. The clarity of the pages is breathtaking; very easy to read. This is a brilliant idea: Wish I had known about it earlier. - Barry, UK

www.grove-ent.com

800-438-8155

order@grove-ent.com

The time to go digital is NOW! ORDER TODAY!



# With a WiNRADiO receiver, you are always onto a winner.

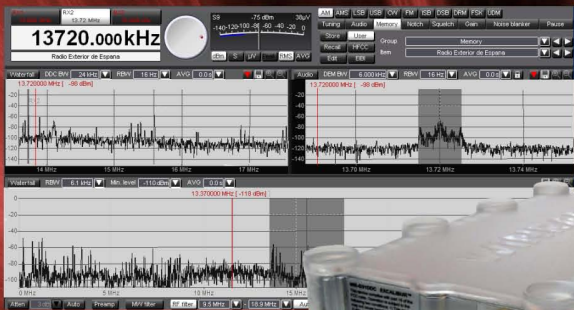

## WinRadio Excalibur Pro

towards set-up measurement protocols but it is abundantly clear that the Excalibur Pro is better than anything we have hitherto encountered. To be able to connect a full-size 6/7MHz dipole to a receiver on an autumn evening and be able to observe the sideband sets of individual broadcasters down to virtually the receiver's noise floor is – to put it mildly – an unusual position for a reviewer to find himself in! Certainly the Excalibur Pro was not remotely troubled at any time by anything our various antennas could throw at it.

### CONCLUSION

The Excalibur Pro is the best SDR we have used – in some ways it is the best receiver we have used regardless of the underlying architecture –

[www.wrth.com](http://www.wrth.com)

Overall rating ★★★★★



## review

Mike Richards takes a look at the WiNRADiO G39DDC Excelsior, a receiver that some might consider the best software defined radio currently available.

If there's one thing that is likely to be at the top of a radio enthusiast's wish list, it's a system that can find signals quickly. The WINRADiO G39DDC Excelsior certainly has the ability to do this and it must be something close to a dream receiver.

### summary

ew, the WiNRADiO G39DDC Excelsior is a stunning receiver and a dream for me, I have only really covered the most interesting aspects of its performance.

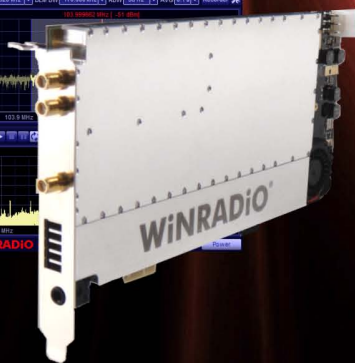
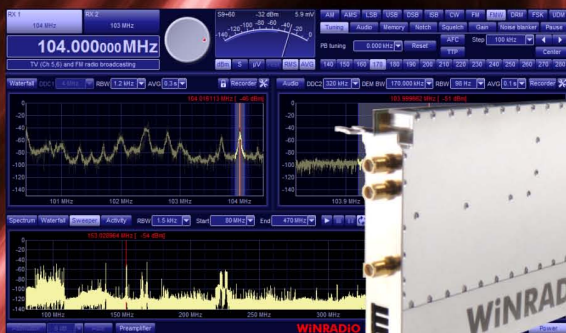

## FIRST LOOK

MT Takes a Look at the Latest Tech

By Bob Grove, W8JHD

This is the most amazing receiver I've ever encountered. It employs the latest proven SDR architecture, operates well beyond the spectral range that most of us would ever think of trying to hear, and demodulates all conventional modes.

I ordinarily find something to complain about in my reviews, but trying to find something I don't like about the G39DDC has left me at a loss, and that's a gain for this winner.

We have lots of good gear. Take a look:  
[www.winradio.com/gear](http://www.winradio.com/gear)

WiNRADiO® by RADIXON®: Great receivers ahead of their time.™





**W9GRS: From Room 104 to the World! ..... 8**

**By Troy J. Simpson W9KVR**

Troy Simpson had no intention of becoming a ham. He thought of himself as a teacher who taught Earth Science at Glenn Raymond School, a middle school with some 300 students in rural southern Illinois. But, his father-in-law had other ideas. Now an Extra Class licensee, Volunteer Examiner and Vice-president of the local amateur radio club in Watseka, Illinois, Troy makes amateur radio part of his students' daily activities.

In this month's cover story, Troy tells the rest of us how he motivates students at an otherwise difficult age to enjoy the world of amateur radio. With the help of the local amateur radio club, Troy's class is a clear voice during the semi-annual School Club Roundup.

These kids know what they're doing; the "Morning DX Crew" at the school's amateur radio station has even achieved DXCC! He tells his students, "The world is just a wave-length away and you never know what part of the world you'll reach today."

*On Our Cover*

The W9GRS Morning DX Crew from Room 104 display their DXCC certificate. First row - Amanda Musselman, Jake Anderson KC9OQN, Jesse Hurst. Second row - Madi Hebert, Mariah Yelenick, Toby Jones, Troy J. Simpson W9KVR science teacher

C O N T E N T S

**A Decade of Amateur Radio in the Classroom..... 11**

**By Buddy Sohl KC4WQ**

"All great things start with a dream and so does this story," says Buddy Sohl KC4WQ. The story is about Buddy's decade long efforts to bring amateur radio to the students of St. Aloysius School in Shepardsville, Kentucky. From the dream of Buddy's uncle to have someone in the family continue the ham tradition, to the reality of Buddy's philosophy of "Train Your Replacement," this story has taken Buddy on an unexpected journey.



**2012 School Club Roundup ..... 13**

**By Ken Reitz KS4ZR**

It's the opposite of what you've come to expect from an amateur radio contest: Instead of taking place over a two day weekend, School Club Roundup takes place during school hours on weekdays and you're not allowed to operate more than 24 hours for the duration! How is that fun? You'll be talking with the future of amateur radio and you may be surprised at how good it sounds.

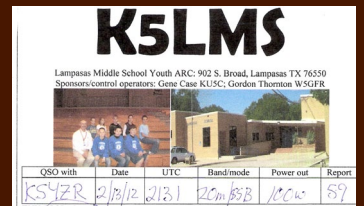

**A Quest to Find the Disappearing Sunspots ..... 15**

**By Russ Steele KF6TAR**

A life-long interest in shortwave listening, careers in the U.S. Air Force and as a concept developer for aerospace company TRW, led Russ Steele KF6TAR to study amateur radio astronomy and the solar cycle. Recently his interest in sunspots brought him to a technical paper written for the National Solar Observatory (NSO) by William Livingston and Matthew Penn. The paper indicates an extreme minimum in the next solar cycle. With a trip planned to the Kitt Peak McMath-Pierce Solar Telescope, Russ found himself on a quest to find out more about the disappearing sunspots.

**Opposition and Clandestine Broadcasts Target Sudan and Darfur ..... 18**

**By Steven Handler**

Granted independence from the British in 1955, Sudan has seen little more than war since. Now officially two countries, the air waves over Sudan are filled with the voices of competing interests on all sides. Steven Handler details the return to shortwave of the exotic local music and languages from this troubled region.

R E V I E W S

**Digital Dave's Delightful Degen DSP Disclosure..... 70**

**By Dave Schmarler N2DS**

Dave Schmarler has knocked around the world of radio long enough to recognize a bargain when he sees one. And, at \$21 (including shipping!) Dave couldn't resist the Degen DE321 AM/FM/SW radio. Could anything cheaper than the total cost to return it actually be useful as a radio? Dave dives into the insides of this little radio to find out.





# AR5001D Wide Coverage Professional Grade Communications Receiver

## The Legend Lives On!



**The AR5001D delivers amazing performance in terms of accuracy, sensitivity and speed.**

Available in both professional and consumer versions, the AR5001D features wide frequency coverage from 40 KHz to 3.15 GHz\*, with no interruptions.

Developed to meet the monitoring needs of security professionals and government agencies, the AR5001D can be controlled through a PC running Windows XP or higher. Up to three channels can be monitored simultaneously. Fast Fourier Transform algorithms provide a very fast and high level of signal processing, allowing the receiver to scan through large frequency segments quickly and accurately. AR5001D standard features include storage of up to 2000 frequencies, 45 MHz IF digital signal processing, direct digital sampling, a high performance analog RF front-end, a DDS local oscillator and advanced signal detection capabilities which can detect hidden transmitters. With its popular analog signal meter and large easy-to-read digital spectrum display, the AR5001D is destined to become the choice of federal, state and local law enforcement agencies, the military, emergency managers, diplomatic service, news-gathering operations, and home monitoring enthusiasts.

Discover the next generation in AOR's legendary line of professional grade desktop communications receivers.

- Multimode receives AM, wide and narrow FM, upper and lower sideband and CW
- Up to 2000 alphanumeric memories (50 channels X 40 banks) can be stored
- Analog S-meter
- Fast Fourier Transform algorithms
- Operated by a Windows XP or higher computer through a USB interface using a provided software package that controls all of the receiver's functions
- An SD memory card port can be used to store recorded audio
- Analog composite video output connector
- CTCSS and DCS squelch operation
- Two selectable Type N antenna input ports
- Adjustable analog 45 MHz IF output with 15 MHz bandwidth
- Triple-conversion receiver exhibits excellent sensitivity
- Powered by 12 volts DC (AC Adapter included), it can be operated as a base or mobile unit
- Professional (government) version is equipped with a standard voice-inversion monitoring feature

**Add to the capabilities of the AR5001D with options:**

- Optional APCO-25 decoder
- Optional LAN interface unit enables control via the internet
- Optional I/Q output port allows capture of up to 1 MHz onto a computer hard drive or external storage device
- Optional AR-I/Q Windows software facilitates the easy storage and playback of transmissions captured within the selected spectrum in conventional modes, or, signals can be subjected to further analysis
- Optional GPS board can be used for an accurate time base and for time stamping digital I/Q data



® The Serious Choice in Advanced Technology Receivers

**AOR U.S.A., Inc.**  
20655 S. Western Ave., Suite 112  
Torrance, CA 90501, USA  
Tel: 310-787-8615 Fax: 310-787-8619  
info@aorusa.com • www.aorusa.com

\*Cellular blocked for US consumer version. Unblocked version available to qualified purchasers with documentation. Specifications subject to change without notice or obligation





**MONITORING TIMES**  
(ISSN: 0889-5341;  
Publishers Mail Agree-  
ment #1253492) is  
published monthly by  
Grove Enterprises, Inc.,  
Brasstown, North Caro-  
lina, USA.

Copyright © 2012 Grove Enterprises, Inc. Periodicals postage paid at Brasstown, NC, and additional mailing offices. Short excerpts may be reprinted with appropriate credit. Complete articles may not be reproduced without permission.

Address: 7540 Highway 64 West,  
Brasstown, NC 28902-0098  
Telephone: (828) 837-9200  
Fax: (828) 837-2216 (24 hours)  
Internet Address: [www.grove-ent.com](http://www.grove-ent.com) or  
[www.monitoringtimes.com](http://www.monitoringtimes.com)  
Editorial e-mail: [editor@monitoringtimes.com](mailto:editor@monitoringtimes.com)  
Subscriptions: [order@grove-ent.com](mailto:order@grove-ent.com)

Subscription Rates: \$32.95 in US; \$42.95 Canada; and \$58.95 foreign elsewhere, US funds. Label indicates number of issues left. Renewal notice is cover sheet 3 months before expiration. See page 76 for subscription information.

**WRITE FOR MONITORING TIMES:**  
Learn how at  
[www.monitoringtimes.com/html/write\\_for\\_mt.html](http://www.monitoringtimes.com/html/write_for_mt.html) or  
write to [editor@monitoringtimes.com](mailto:editor@monitoringtimes.com)

Postmaster:  
Send address changes to *Monitoring Times*, 7540 Highway 64 West, Brasstown, NC 28902-0098.

**Disclaimer:**  
While *Monitoring Times* makes an effort to ensure the information it publishes is accurate, it cannot be held liable for the contents. The reader assumes any risk for performing modification or construction projects published in *Monitoring Times*. Opinion or conclusions expressed are not necessarily the view of *Monitoring Times* or Grove Enterprises. Unsolicited manuscripts are accepted. SASE if material is to be returned.

**Subscription Questions?**  
[belinda@grove-ent.com](mailto:belinda@grove-ent.com)

**Owners**  
Bob and Judy Grove  
[judy@grove-ent.com](mailto:judy@grove-ent.com)

**Publisher**  
Bob Grove, W8JHD  
[bobgrove@monitoringtimes.com](mailto:bobgrove@monitoringtimes.com)

**Managing Editor**  
Rachel Baughn, KE4OPD  
[editor@monitoringtimes.com](mailto:editor@monitoringtimes.com)

**Assistant and Reviews Editor**  
Larry Van Horn, N5FPW  
[larryvanhorn@monitoringtimes.com](mailto:larryvanhorn@monitoringtimes.com)

**Features Editor**  
Ken Reitz  
[kenreitz@monitoringtimes.com](mailto:kenreitz@monitoringtimes.com)

**Art Director**  
Bill Grove

**Advertising Services**  
Judy Grove  
(828) 837-9200  
[judy@grove-ent.com](mailto:judy@grove-ent.com)

## TABLE OF CONTENTS

### Departments:

|                        |    |
|------------------------|----|
| Communications .....   | 6  |
| Letters .....          | 74 |
| Stock Exchange.....    | 76 |
| Advertisers Index..... | 76 |

### First Departments

|   |    |
|---|----|
| <b>Getting Started</b>                                  |    |
| Scanning Report .....                                   | 20 |
| By Dan Veeneman<br><i>Adapting an AOR8000 to Change</i> |    |

|  |    |
|--|----|
| Ask Bob .....  | 23 |
| By Bob Grove W8JHD<br><i>Correction and oversight; Horizontal loop details; Earth SW broadcasts on ISS; Using two SW receivers on the same antenna; Grounding a wire antenna; Drugstore tube-testers; Who keeps track of space debris?</i> |    |

|  |    |
|--|----|
| Utility World .....  | 24 |
| By Hugh Stegman NV6H<br><i>Dutch Spy Bust Fuels New "Numbers" Intrigue</i> |    |

|   |    |
|---|----|
| Digital Digest.....                                 | 27 |
| By Mike Chace<br><i>Digital Spotlight on Brazil</i> |    |

|  |    |
|--|----|
| On the Ham Bands .....   | 28 |
| By Kirk Kleinschmidt NT0Z<br><i>Antenna Secrets I Wish I'd Known</i> |    |

|   |    |
|---|----|
| Beginner's Corner .....   | 30 |
| By Ken Reitz KS4ZR<br><i>Beginner's Update: Antenna Lead-in</i> |    |

|  |    |
|--|----|
| Programming Spotlight.....                                 | 32 |
| By Fred Waterer<br><i>Revisiting the Former Yugoslavia</i> |    |

### Second Departments

|  |    |
|--|----|
| QSL Report .....   | 34 |
| By Gayle Van Horn W4GVH<br><i>QSLing from the "Most Wanted" List</i> |    |

|                                 |    |
|---------------------------------|----|
| English Language SW Guide ..... | 34 |
|---------------------------------|----|

|                                     |  |
|-------------------------------------|--|
| MTXtra.Shortwave Broadcast Guide 47 |  |
| <i>Chinese and Spanish Language</i> |  |

|  |    |
|--|----|
| Milcom .....   | 52 |
| By Larry Van Horn N5FPW<br><i>Is the Cold War Really Over?</i> |    |

|   |    |
|---|----|
| Fed Files .....   | 54 |
| By Chris Parris<br><i>A Fed Files Radio Safari: Southern Nevada</i> |    |

|  |    |
|--|----|
| Boats, Planes, TRAINS .....            | 56 |
| By Ernest Robl<br><i>Stepping Back</i> |    |

|   |    |
|---|----|
| Globalnet .....   | 58 |
| By Loyd Van Horn W4LVH<br><i>The Future of Internet Radio: Could it come at a cost?</i> |    |

|  |    |
|--|----|
| Below 500 kHz .....                                    | 60 |
| By Kevin Carey WB2QMY<br><i>Summertime, Summertime</i> |    |

### Technical Departments

|  |    |
|--|----|
| Radio Restorations.....                                      | 62 |
| By Marc Ellis N9EWJ<br><i>Finishing up the Arvin Project</i> |    |

|   |    |
|---|----|
| Antenna Topics .....  | 64 |
| By Dan Farber AC0LW<br><i>Receiving-Only Antennas: A Shortwave Listener's Perspective</i> |    |

|   |    |
|---|----|
| Sky Surfing: Radio Astronomy .....                  | 66 |
| By Stan Nelson KB5VL<br><i>Spying on Exoplanets</i> |    |

|   |    |
|---|----|
| On the Bench.....   | 68 |
| By Mario Filippi, N2HUN<br><i>Setting Up a Ku-Band FTA Radio System</i> |    |

|   |    |
|---|----|
| First Look .....  | 70 |
| By Dave Schmarder N2DS<br><i>Digital Dave's Delightful Degen DE321 DSP Disclosure</i> |    |

|  |    |
|--|----|
| What's New .....   | 72 |
| By Larry Van Horn N5FPW<br><i>ARRL's Low Power Communication; Short Antennas for 160 Meters; ARRL Extra Class License Manual; ARRL's Extra Q&amp;A 3rd Edition; DX Engineering 160 Meter Vertical Antenna; Wavcom Releases New Updates; New Features for inReach Communicator.</i> |    |

You may contact any MT staff writer by email by combining their **first and last name @ monitoringtimes.com**. By postal mail, you may write them in care of MT Headquarters in Brasstown. Please enclose a self-addressed, stamped envelope if you wish the columnist to reply.



**Study with the best!**  
**License Study Materials by**

# Gordon West, WB6NOA & the W5YI Group



## TECHNICIAN CLASS



**Technician Class book** for the 2010-2014 entry level exam! Gordo reorganizes the Q&A into logical topic groups for easy learning! Key words are highlighted in his explanations to help you understand the material for test success. Web addresses for more than 125 helpful, educational sites. Includes *On The Air CD*

demonstrating Tech privileges. **GWTM \$20.95**

### Tech Book & Software Package

Gordo's book with W5YI software allows you to study at your computer and take practice exams. Explanations from Gordo's book are on the software - answer a question wrong and his explanation appears to reinforce your learning. Includes free Part 97 Rule Book. **NCS \$29.95**

### Tech Audio Course on CD

*Welcome to Gordo's classroom!* Technician audio theory course recorded by Gordo talks you through the Element 2 question pool. Follows the order of his *Technician Class* book, and is full of the sounds of ham radio operating excitement! An excellent study aid if you spend a lot of time in your car or pick-up! On 4 audio CDs. **GWTW \$29.95**

## GENERAL CLASS



**General Class book** Upgrade to the HF bands with Gordo & W5YI! Gordo's manual for 2011-2015 reorganizes all the questions into logical topic groups for easier learning. His explanations include highlighted key words to help you remember the material for test success. Companion CD is full of great operating tips! Available about May 1st. **GWGM \$24.95**

### General Book & Software Package

Study at your computer and take practice exams. Software includes explanations from Gordo's book, scores your results and highlights areas that need further study. Includes free Part 97 Rule Book. **GUS \$34.95**

### General Audio Course on CD

General Theory Course recorded by Gordo is full of the sounds that bring ham radio to life! He talks you through the Element 3 theory to help you understand the material and get you ready for your upcoming exam. On 4 audio CDs. **GWGW \$29.95**

## EXTRA CLASS



**Extra Class book** Go to the top with Gordo! 2008-2012 book includes all Element 4 Q&A reorganized into logical topic groups. Gordo's fun, educational explanations with highlighted keywords, and great memory tricks for those tough theory questions! Wait 'til you meet "Eli the Ice Man!" **GWEM \$24.95**

### Extra Book & Software Package

Study at your computer and take practice exams as the W5YI software scores your results and highlights areas that need further study. Includes explanations from Gordo's book. Free Part 97 Rule Book. **ECS \$39.95**

### Extra Audio Course on CD

Extra Class Theory Course recorded by Gordo talks you through the difficult Element 4 theory to help you understand the material and get you ready for your upgrade to the top. On 6 audio CDs. **GWEE \$39.95**

### Ham Operator Software has All Exams

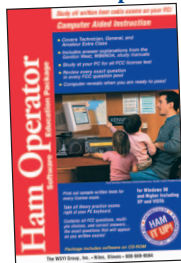

**Want to study at your computer without tying up your internet connection?** This value pack includes the Tech, General and Extra class exams (Elements 2, 3, and 4) along with a free Part 97 Rule Book. Software includes Gordo's answer explanations from his books! Everything you need to go all the way to the top!

Software only **HOS \$29.95**  
 Software with all 3 West Books **HOSB \$89.95**



### Using Your Meter

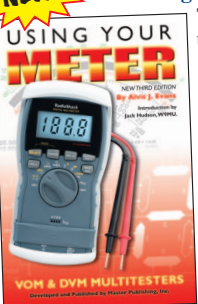

Teach yourself the correct use of your multimeter. Book explains fundamental concepts of electricity including conventional and electron current and series and parallel circuits. It teaches how analog and digital meters work and tells you what the voltage, current and, resistance measurements mean. Then it provides fully-illustrated, step-by-step instruction

on using your meter in practical applications in the home, workshop, automotive and other settings. An excellent learning tool and reference for the hobbyist and ham. **METR \$24.95**

## GROL + RADAR



Get your FCC commercial radio licenses and add valuable credentials to your resume! **GROL+RADAR** includes the new FCC Element 1 question pool for the Marine Radio Operator Permit (MROP), the Element 3 pool for the General Radiotelephone Operator License (GROL), and the Element 8 pool for the RADAR Endorsement. Many employers require these licenses for jobs in marine, aero, safety, and municipal positions. Gordo and his team have written clear explanations for all the Q&A to make studying for these exams educational and fun. If you're an Extra Class ham, many of the technical/math questions will look familiar to you. Fully-illustrated to aid your learning. Book includes a searchable CD-ROM with all FCC Rules for Parts 2, 13, 23, 73, 80 and 87. **GROL \$49.95**

### GROL+RADAR book & software package

Enhance your learning experience using our practice exam software along with the **GROL+RADAR** book. Software includes answer explanations from the book - when you select a wrong answer, the explanation from the book appears to reinforce your learning. **GRSP \$79.95**

### Getting Started in Electronics

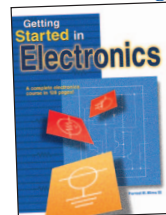

by Forrest M. Mims  
 A great introduction for anyone who wants to learn the fundamentals of electronics. Includes 100 projects you can build, and great experiments that demonstrate how electricity works! **GSTD \$19.95**

### Engineer's Mini Notebooks



These Mims classics teach you hands-on electronics! Study and build 100s of practical circuits and fun projects. Each volume contains several of his famous Mini Notebooks. Terrific ideas for science fair projects and a great way to learn about electronics!

- Useful reference guides for your workbook!
- Vol. 1: Timer, Op Amp, & Optoelectronic Circuits & Projects** **MINI-1 \$12.95**
  - Vol. 2: Science & Communications Circuits & Projects** **MINI-2 \$12.95**
  - Vol. 3: Electronic Sensor Circuits & Projects** **MINI-3 \$12.95**
  - Vol. 4: Electronic Formulas, Symbols & Circuits** **MINI-4 \$12.95**

**Order today from W5YI: 800-669-9594 or on-line: www.w5yi.org**

The W5YI Group P.O. Box 200065 Arlington, TX 76006-0065

Mention code 053736 for a free gift with your order!





# COMMUNICATIONS

by Ken Reitz



## AMATEUR/SHORTWAVE

### Illinois OKs State PRB-1

On June 30 the state of Illinois became the twenty-ninth state to codify PRB-1, the FCC's Opinion Memorandum and Order of 1985 that preempts state and local regulations pertaining to amateur radio facilities, into that state's laws. According to a press release from the ARRL, the bill looked doomed for this legislative session until Illinois State Representative Charles Krezwick WV9C and the ARRL's state liaison got together to push the bill through.

Despite being federal law since 1985, states and municipal governments across the country continue to enact laws making unreasonable demands on amateur radio operators regarding placement and height of amateur radio antennas and structures. When challenged, such regulations are overruled by enforcement of PRB-1. As stated in PRB-1, "State and local regulations that operate to preclude amateur communications in their communities are in direct conflict with federal objectives and must be preempted."

However, regulations devised by Home Owners Associations as part of deed restrictions in private developments are a different matter and not necessarily trumped by PRB-1. It's up to the amateur operator under such restrictions to bring action against local regulations. Help in this regard can be found at the ARRL website: [www.arrl.org/antenna-regulation-and-zoning](http://www.arrl.org/antenna-regulation-and-zoning).

Earlier this year the FCC sought to study the issue of antenna regulation and zoning and asked the League's help during the brief comment filing period. According to the ARRL, more than 1,800 email comments were received.

### DRM Glacier inches Forward

The Digital Radio Mondiale (DRM) consortium road show found itself in South Korea in early July, promoting acceptance of DRM transmissions to that country's AM and shortwave broadcasters. Korea is home to many electronic manufacturing companies, some of which produce many of the world's shortwave radios.

According to a DRM press release, "There has been a growing demand from re-



ceiver manufacturers, to have a DRM chipset and a number of Korean chipset manufacturers are working hard to develop this as soon as possible." The group then went to Japan to meet with Japanese manufacturers. The group stated, "As in South Korea, Japan has also put together a plan to renew their shortwave transmitters with those with DRM capability."

## PUBLIC SERVICE

### Pasadena PD allow Press Scanner Access

An article in the *Pasadena Star-News* from June 20 notes that the city's police department had finally allowed the *Star-News* access to the department's fully encrypted police signal. Said *Star-News* editor Frank Girardot, "It still amazes me that officials think the public shouldn't have access to the full spectrum of police communications in Pasadena, but this is a step in the right direction."

The police department relented after more than five months of scanner silence and continued press attention to the issue. Even so, the public continues to be frozen out of police transmissions. The newspaper noted that the public will be able to hear the initial call on scanners capable of receiving their trunked transmissions, but immediately after the initial call, the rest becomes encrypted. Only the newspaper will hear the full transmission.

## AM/FM/TV BROADCASTING

### An All-HD AM Future?

According to an article in *Radio World* online, the National Association of Broadcasting's (NAB) committee on radio engineering is considering running tests that may show how iBiquity's In-Band On-Channel (IBOC) digital mode, known to mortals as HD-Radio, would function on a completely digital AM band.

I asked *MT's* Broadcast Bandscan columnist Doug Smith W9WI for his take on the issue. He noted that currently IBOC stations transmit in a "hybrid" mode, "They transmit analog and digital simultaneously, on the same frequency. As a result, the digital power must be greatly limited

to avoid self-interference. At the same time, the digital signal spreads out into adjacent channels, generating interference and further limiting the digital power.

"A station that runs 5,000 watts in analog can run no more than 50 watts of digital. By getting rid of the analog signal, they don't need to worry about interfering with it and they can move the digital sidebands into the existing channel, so they don't have to worry about interfering with anyone else. They should be able to run 5,000 watts of digital power.

"Obviously that would lead to vastly better results. Testing is necessary to know just how much better that signal would be. I suspect the difference would be somewhere between dramatic and stunning. Of course, converting a station to 100% digital would also cost it nearly all of its audience, given how few HD Radios are out there. I suspect they'll find something few engineers could dispute: that full-digital IBOC works pretty well both in terms of the station's own coverage, and in less interference to other stations. Unfortunately, the engineers can't fix the lack of receiver penetration."

### AM Radio? Nothing Comes to Mind

That's what ten percent of respondents to a survey, conducted in June by Mark Kasoff & Co., a research consultancy, said when asked, "What's the very first thing that pops into your mind when you think of AM radio?" Worse, a further eleven percent said they don't or rarely listen to AM radio. The telephone study interviewed 412 people across the U.S. aged 18-64.

The report concludes in part, "...non-music programming is successfully shifting to FM. As that shift continues, AM's 'franchise' on those services — its remaining *raison d'être* — will be gone. Based on this research, many won't even notice. Take away talk, news and sports. What does AM end up with? Nothing."

### FCC under Fire on Repacking

Granted that it's one of the most pivotal of modern federal agencies, the FCC has done little to engender friendship on or off Capitol Hill. Now the Commission appears to be dragging its feet on letting Congress in on expectations for its Allotment Optimization Model (AOM): exactly how the FCC plans to develop the "incentive auction" and how many TV stations may be asked to leave the air in order to provide spectrum that will be auctioned off to mobile broadband interests.





According to Deborah McAdams' column in *TV Technology* online, after shrugging off similar requests a year ago, FCC Chairman Julius Genachowski appeared before a congressional committee to say basically, "all will be revealed." To counter this recalcitrance one committee member, John Dingell (D-MI), threatened to sue the FCC to get the information.

McAdams noted in her column, "The AOM would provide information on how many TV stations would go off the air according to how much broadcast spectrum is auctioned off for wireless broadband. The National Association of Broadcasters has estimated that as many as 210 stations would go dark should the FCC secure the 120 MHz it seeks for auction." One broadcast insider noted the difficulty of potentially repacking 1,800 TV stations in a three year period into spectrum cut by 40 percent. Details about the much anticipated spectrum auction are expected to emerge from the FCC this fall.

## SATELLITE

### Billionaires Compete in Launch Biz

With the U.S. reduced to paying Russia to launch our non-spy satellites the super-rich are clamoring to get in on the action. June's successful launch and rendezvous of the privately built SpaceX spacecraft, named Dragon, to the International Space Station (ISS) showed that its Commercial Orbiting Transfer Service (COTS) was viable. The company plans to transfer astronauts from Earth to space in the future. The brains (and the bucks) behind SpaceX is Elon Musk, co-founder of PayPal, who is listed on the SpaceX web site as founder, Chief Executive Officer and Chief Designer. Musk multi-tasks his SpaceX ventures with his electric car company Tesla Motors.

Not to be outshone in anyone's galaxy is Virgin Record's founder Sir Richard Branson who announced in early July that his own private space company, Virgin Galactic, will also offer its own satellite launch vehicle dubbed, unimaginatively, LauncherOne. Their lofty plans include space tourism for the truly super-rich, an environmental Earth monitoring company and asteroid mining endeavors.

Proving that it's hard to resist the lime-light, billionaire co-founder of Microsoft, Paul Allen, has teamed up with Aerospace pioneer Burt Rutan to found Stratolaunch Systems which is currently partnering with SpaceX on a launch project. Apparently everyone needs a hobby.



## FCC ENFORCEMENT

### Major FM Pirates Hit with NOUO

According FCC records, a Notice of Unlicensed Operation (NOUO) was issued to a Boulder, Colorado man for his illegal FM station on 90.7 MHz with an amazing 351,133 microvolts per meter at three meters. Some 15 lesser pirate operations were also cited in the last month including two in Newark, New Jersey, one in Randolph, Massachusetts and two in Brooklyn, New York.

A pirate in Lawrence, Massachusetts operating on 99.1 MHz with more than 365,000 microvolts at 81 meters must have had a huge signal. A station calling itself Radio Free Olympia, operating on 98.5 MHz from Olympia, Washington, was observed with a signal in excess of 757,000 microvolts at 3 meters.

But, nobody tops this month's QRO (high power) pirate broadcaster, also from Boulder, Colorado, operating on 95.3 MHz with over 900,000 microvolts per meter at 3 meters. The maximum allowed under Part 15 rules for unlicensed operation is 250 microvolts at 3 meters.

### Dog Shot in Pirate Raid

According to an article in the southern Florida *Sun-Sentinel*, sheriff's deputies shot a pit bull as it apparently charged them while they were attempting to serve a search warrant on a location thought to be the source of an unlicensed radio station broadcasting, "hip-hop music and coarse language at 89.5 FM," according to the article. The station was said to be interfering with the signals of a Christian formatted station near the pirate station on the FM dial. The report noted that the officers confiscated the broadcast equipment.

### FM Pirate is also a Ham

Back on February 4 of this year, FCC field agents operating in Suisun City, California, used direction finding equipment to track an unlicensed FM signal operating on 104.9 MHz and IDing as KBRS.

According to FCC documents, the agents heard the station operating in the garage at the residence and attempted to inspect the station, but got no response from their knock at the door. The agents posted a Notice of Unlicensed Operation (NOUO) at the front door and noted that when they left the area, the signal disappeared.

The FCC noted that the operator held a Technician Class license for at least six years and "should be aware that any radio equipment at this station must be made available for inspection at any time when requested by the FCC." Unfortunately, that fact only added to the fine. Operating a radio station without



authorization: \$10,000. Failure to allow inspection of a radio station: \$7,000. Total due: \$17,000.

### Talkative Miami Pirate Silenced

Sometimes pirate operators make it all too easy for FCC field agents. Last March agents were in Miami monitoring a station transmitting on 92.7 MHz. The announcer identified himself on the air as "DJ Miami of 92.7 Heavy FM" and advertised his website (which has since been taken down). The agents located the website and on the "bio" page learned the operator's name and saw his photograph. The website also linked to his Facebook page.

Sitting around the lobby of the building where the station had leased office space, the agents ran into DJ Miami who admitted who he was and ushered the agents up to a suite of offices where he admitted to having purchased the station equipment. DJ Miami then turned off the equipment, demonstrating he had control of the station. The rest was routine. DJ Miami received a \$10,000 fine, but, at least he allowed the inspection and saved himself an additional \$7,000 in fines.

*Communications is compiled and edited by Ken Reitz, KS4ZR (kenreitz@monitoringtimes.com) from clippings and links provided by our readers. Many thanks to this month's fine reporters: Anonymous, Rachel Baughn, Bob Grove, Norm Hill, Steve Karnes, and Larry Van Horn.*

## NASB

### National Association of Shortwave Broadcasters

Representing the privately-owned shortwave stations in the USA

- Find links to all of our members at [www.shortwave.org](http://www.shortwave.org)
- Take the NASB Shortwave Listener Survey and get a free subscription to the NASB Newsletter. [www.surveymonkey.com/s/6LRVLJ7](http://www.surveymonkey.com/s/6LRVLJ7)
- Listen to "The Voice of the NASB" on HCJB's DX Party Line on WRMI's 9955 kHz. Visit [www.wrmi.net](http://www.wrmi.net) for schedule
- NASB is a member of the HFCC (High Frequency Coordination Conference) and the DRM (Digital Radio Mondiale) Consortium



# W9GRS: From Room 104 to the World!

By Troy J. Simpson W9KVR  
(Photos courtesy the author)

It all began with a visit to my father-in-law's house. Mike Marcier KC9HHT just had to show me his new Kenwood TH-D7 handheld radio. He was all excited about getting his station set up after recently renewing his interest in amateur radio. As he continued to show me the features, I couldn't help but think that my father-in-law was an absolute nerd and I really didn't want any part of it.

But, Mike is not one to easily push aside when it comes to something he is passionate about, and I should have known then that he had something that could make an impact not only on the students of Glenn Raymond School, but on me as well.

But, first, a little background. I teach junior high science in the rural community of Watseka, Illinois. Glenn Raymond School is a public junior high school with approximately 300 students in grades six to eight. Even though my primary focus may be Earth Science, I love to integrate technology whenever possible into my lessons. I'm also chief sponsor of our science club, which taps into a variety of activities from canoeing, to rocketry, to gun safety (we are in deer country, so hunting is a big deal) which meets after school once a week.

It was the fall of 2005, and in the follow-

ing spring our science club would be celebrating its thirtieth anniversary. Now, enter the Iroquois County Amateur Radio Club (ICARC). The group has been meeting since the 1960s and my good old father-in-law had a plan to help spur me on to get amateur radio in the school. He mentioned that perhaps we could have a special event station to celebrate the milestone with assistance from ICARC.

Before I knew it, I was attending a meeting and explaining about the science club and asking if it would be feasible to put something together. The enthusiasm was contagious as members began to immediately brainstorm how to put this together. By the end of the night, a plan was in place and we would attempt to get on the air to help celebrate our school science club's anniversary.

## On the Air from Glenn Raymond School

The day had arrived and it was time to put antennas up. It was decided to put two temporary push-up masts on the roof, directly above my



Mike Marcier KC9HHT answering questions about PSK31 during the Science Club's 30th Anniversary Celebration.

classroom. A 20-meter dipole would be strung between the masts and coax run through a window to my classroom. Mike brought along his Kenwood TS-2000 which we connected to my classroom computer. After a quick test with an antenna analyzer, we were ready to go!

We passed around a copy of the March 2006 *QST* magazine which showed our special event listed, while Mike, along with former teacher Sam Ripple W9QKF (now a Silent Key), demonstrated the different aspects of amateur radio making Morse code (CW), voice, and digital contacts. A highlight was utilizing the classroom interactive whiteboard to project PSK31 for all to see and then with a touch on the screen, view signals going across the waterfall.

In a matter of 90 minutes, we contacted stations in Colombia, Brazil, Belgium, and even Australia. Students and staff alike were amazed that a little signal coming from a classroom in East Central Illinois could make connections literally around the world. At this point, I knew that perhaps my father-in-law might just be on to something.

The first step for me seemed logical: get licensed. After a bit of studying I earned my Technician Class license with the call sign KC9MCA in 2007. Not a bad call, but with the vanity call sign program in place, I wanted something more akin to who I am. I was able to get W9KVR, which signifies my interest in exploring and surveying caves. With that done, the next step was to see what it takes to get a station established at the school.

I talked with the school administration and as far as they were concerned, if it didn't cost the district any money and didn't damage the building, we could proceed. I thought that was fair enough, and with that, I was on my way. I researched what other school stations did to get the equipment they needed. Some schools had equipment on loan from local clubs, others had staff members who donated equipment, and some applied for and earned grants from organizations such as the ARRL.

That idea got my attention, because I had become an ARRL member and read about the School Club Round-Up (SCR) that took place every year with schools across the country. I looked at which schools were awarded grants



Jake Anderson KC9OQN and Justin Moyer operate W9GRS using SSB during School Club Roundup.



and decided to seek some further guidance. I contacted Neil Rapp WB9VPG who teaches high school science at Bloomington South High School, Indiana (K9SOU). I picked his brain about everything from operating, what equipment to get, and how I should approach writing a grant application. He was very helpful in giving me suggestions and was enthusiastic about getting another school on air.

## W9GRS's first SCR

We wanted to make a serious attempt at this, so I applied for a club call sign for the school. In April 2008, we were assigned KC9NEW, but we quickly applied for and received W9GRS to help better identify us as a school station. With the May deadline approaching for ARRL grants, I fine-tuned our purpose and goals in the application. First and foremost we wanted to have a station that could fulfill multiple roles. Yes, the long distance contacts with other countries is a great hook for students, but we could also tap into the civic roles radio plays, such as in SKYWARN and emergency communications.

The proposal addressed all of these ideas as we took advantage of integrating radio communications with the meteorology unit I teach in class. Also written in the grant is the availability for communications during emergencies when the school is utilized as a potential emergency shelter.

The summer of 2008 was an exciting time as the school grounds hosted the Iroquois County Amateur Radio Club (ICARC) for Field Day activities for the first time in several years. Then, as the school year approached, I received a letter from the ARRL congratulating us on earning an Education & Technology Program (ETP) grant to help establish the W9GRS station.

By fall, thanks to the ETP grant, we had vertical HF and VHF/UHF tri-band antennas up on our school roof with a Kenwood TS-480SAT to bring the antennas to life. We added a Kenwood TS-271A to give us the 2 meter local access and also help meet the goal of providing communications capabilities in the event that the school is used as an emergency shelter.

The equipment arrived in late September and none too soon, as the School Club Round-Up was fast approaching. I thought this might be a great opportunity to test the waters of radio operation and see where it would take us. I set aside on-air times before and after school and even took some time during a couple of classes to share "the magic" of amateur radio. We only operated on SSB and students were nervously calling "Whiskey 9 Golf Romeo Sierra" with hopes of making contacts.

It was definitely a learning process as we made seven contacts with schools that week and had a total of 43 contacts. I was still very much new to the whole idea of operating HF and felt I was learning as well as the students. Two big results of this operation were that a group of students began meeting before school to operate on a regular basis and students now were interested in getting their licenses.



*Mariah and Madi operate PSK31 during the February 2012 School Club Round-up. Both students are studying for their Technician Class license and will be taking their tests this month.*

## Help from the Local Club

As you might imagine, one of the keys to our success was the school's relationship with the local amateur radio club. Not only was that the catalyst for W9GRS, but it has become a continued support system for the school station. Even though the club is relatively small, members go out of their way to make sure the station is provided for.

Members of ICARC have graciously donated coax cable, a rotator and controller for the tri-band Yagi as well as study materials for licensing and

antenna construction. They've organized Volunteer Exam Coordinator (VEC) testing sessions, and perhaps most importantly, on-air contacts with students. During each School Club Round-up, members of ICARC make a point to contact the school on various modes to help with the QSO total and show support for the students. ICARC is also fortunate to have members who have traveled to rare DX entities and have made a point to get the school station in the log.

The first such contact was with local DXer Jerry Rosalius WB9Z who traveled to Desecheo



*The Wall: Staff and student call signs, along with QSL cards, adorn the wall of Room 104.*





*The "Back 40" of Glenn Raymond School, Field Day site for the Iroquois County Amateur Radio Club, where club members and students operated during Field Day.*

(K5D) during our first year of operation and wanted to make sure the school got the chance to make contact with this rare DX entity. It was quite an experience when the classroom heard "W9GRS, this is K5D, you are 5 and 9. Great to make the contact with the school! 73s!"

Subsequently, Jerry has been at VP8ORK and HK0NA and both times he has made sure to work the school station and whichever licensed students and staff were available at the time.

Another neat experience occurred when Carl Schroeder K9CS traveled to Barbados and set up a schedule for a contact during this past February's School Club Round-up. He then followed up with QSOs with a couple of our students and also got me into the log for a new one on 15 meters. Needless to say, the DX is a big draw for the students and we take advantage of it by further investigating these places and where they are located.

ICARC now has its regular meetings at the school station which promotes the interactions between students and members. This has helped generate not only new members for the local club, but also helped club members find a niche to help promote amateur radio. For me, it's an especially proud moment when former student Chris Jaworski KC9RCD takes over for the Monday night ICARC net on 2 meters, knowing that we have gone full circle.

The school station has also been the location for Field Day activities with the school call representing the GOTA (Get On The Air) station. We have also joined forces with the Kankakee Area Radio Society during the Illinois QSO Party and have been key presenters at their KARSfest convention sharing our experiences regarding what has been going on at the school station.

## SCR Still a Big Event

The School Club Round-up is the main event for the school station each year as it takes place in October and again in February. Our first two years

had us only operating on 10, 15, and 20 meters, utilizing our vertical antenna. But, once again, the local club helped out with my father-in-law, Mike, adding a 40/80/160 dipole he purchased a while back that had been collecting dust.

He suggested that we test the thing out, so we hung it between two trees on either side of the school. The wire hung horizontal southeast to northwest and was 8 feet above the roof line. We tuned it up and suddenly 40 and 80 meters were at our fingertips. It was amazing how many more schools we could work!

A banner moment was being able to finally make a QSO with Neil and our friends at K9SOU, but it wasn't without difficulty. The year before we had tried to make contact, but Bloomington is just the right distance from us so that 20 meters skips right over them. This year, for some reason, they could hear us transmitting on 20 meters in PSK-31 mode, but we could not copy their reply. Neil's crew didn't have 40 meter capability, so that was out.

I wondered if we could hear them on the 40/80/160 meter dipole, so I switched antennas. Lo and behold, I we could see them on the waterfall! The solution presented itself; we would transmit using the vertical and then quickly switch to the dipole for receive. It worked! Finally, we successfully made the long awaited QSO with K9SOU, which has now become a traditional contact between the two schools.

As the W9GRS enters its fifth year on the air, we have consistently finished among the top in the middle school division, helping the 9-Land stations compete with the more established East Coast stations.

## Life with an In-School Ham Shack

As was written in the grant, the goal was to be on-air consistently throughout the year, and

the school has been successful at that, despite the struggle to work around other school activity schedules. The W9GRS Morning DX Crew was a direct result of our operations during the October 2008 School Club Round-up.

A group of students began meeting in my classroom each Thursday morning before school starts. They had been infected by the DXing bug! It was rough going, being able to work SSB only initially, but with the addition of a homebrew digital interface, the text friendly interaction became a new draw.

It wasn't long before the students discovered the world of DX Summit, the online list of DX stations on the air. Now students actively patrol the bands to find new ones to add to the map on the wall overlooking the radio. With our QSL card, designed by students, we've begun exchanging cards and building a collection that is posted on the "Call Sign Wall." When a student earns his or her ticket, their call sign is painted on the classroom wall for all to see. Jake KC9OQN is the first and youngest, being at the ripe age of 10, with several other calls now joining his.

The crew has accomplished its goal of making the DXCC (DX Century Club) and WAS (Worked All States). These morning sessions also allow students to practice for future testing, while other students are trolling the bands for contacts. The school now also sponsors the Worked All States School Stations Award to help encourage contacts with other school stations across the country.

The goal of the school station is to promote all aspects of radio, from science, to civil service, from the DXing and rag-chewing to the competitive contesting. It is exciting to see students become involved in the various aspects of operating. I have found it is contagious, as I have become more involved in my own radio operations, having earned my Extra Class license and participated in SKYWARN, DXing, contesting, and as being a Volunteer Examiner.

I'm looking for more ways to enhance our activities and enjoy chatting with other teachers about how to make it work. We're hoping to get more students on the air and licensed. Ultimately, I hope to fill my classroom wall with call signs.

So, if you ever hear "Whiskey 9 Golf Romeo Sierra" or see W9GRS come across the waterfall, give us a shout out, we'd love to hear from you! As I tell the students, the world is just a wave-length away and you never know what part of the world you'll reach today.

### About the Author:

Troy J. Simpson W9KVR is an eighth grade science teacher at Glenn Raymond School in Watseka, Illinois. He is chief sponsor and trustee of the W9GRS school station and tries to get the station on air as much as possible. He is currently the Iroquois County Amateur Radio Club (ICARC) Vice-President and, despite his busy school schedule, he enjoys working DX and contesting, exploring caves, and helping his 5-year old daughter Sophia toward earning her ticket. Troy may be reached at [tsimpson@watsaka-u9.k12.il.us](mailto:tsimpson@watsaka-u9.k12.il.us)



# Train Your Replacement

## A Decade of Amateur Radio in the Classroom

By Buddy Sohl KC4WQ  
(All photos courtesy the author)

All great things start with a dream, and so does this story. Amateur radio is something that has been around my family since the 1930s, starting with my great uncle Charlie W4KBR. Charlie had tried to introduce ham radio to his brother, his sons, my dad and a few other family members, but none ever got “bit by the bug.” Our family lost Charlie in 1976, his dream of having another ham in the family going unfulfilled. But in 1979, as his great nephew, I got bit by the radio bug and finally there was another ham in the family! One dream fulfilled, albeit a couple of years late, and another just beginning to take root.

It took several years of hands-on learning to get comfortable enough to teach amateur radio, but mentoring and teaching starts early in an active and busy amateur radio avocation. One of the greatest benefits of an amateur radio license is the camaraderie and experience of the ‘old timers,’ and any ham worth his salt will lend a helping hand to an inquisitive novice. As a new ham I was fortunate to be introduced to some amazing radio operators from all over the country. The amount of information received over just a couple of years was daunting.

The first opportunity at teaching amateur radio came when my daughter was in the first grade and I approached the principal of her school to introduce these little ones to Morse code. While it was well received and the kids learned to send their names in CW, the age group wasn’t really appropriate to pursue an amateur radio license.

Over the years there were other opportunities to introduce radio in the classroom, but all were one-day affairs and nothing ever came of it. Honestly, there were times that it seemed that no one in education was interested in the magic of radio. Every administrator that I approached was cordial but not excited, at least not as excited as I was! And of course, the cost of equipment, maintenance, liability concerns about antennas and towers always seemed to kill the deal. Then, along came Cub Scouts, with my sons!

One of the badges a scout can earn has to do with “secret codes.” What a great opportunity to introduce these little guys to Morse code. The guys had a great time, but there was no real avenue to get to real radio here. That opportunity came with Boy Scouts and the radio merit badge. This looked like it was a real opportunity to get some licensed amateurs. The Scout Master even wanted to sit in on the class!

After a six week course and a lot of home study, there were seven scouts who earned their radio merit badges and six who earned their amateur radio licenses. This was the event that re-kindled my interest in getting radio in the classroom again. This was also at the time that the ARRL introduced the ‘Big Project,’ a nationwide effort (now called the Education and Technology Program), that helps teachers and schools establish amateur radio in the classroom.

### Gaining a Foothold in School

For me, the next step was to discuss the program with the principal of the school. She was very interested in the program, especially when I could explain that there would be negligible costs to the school. The first year of the St. Aloysius program was a smashing success. We applied for a Big Project grant and had



*KI4GDR operating during School Club Roundup.*

over 20 fourth through eighth graders coming to play on the radio. This was an after school program (through its entire ten year lifespan) and all the kids would take their time to do something different and fun.

There were several times that parents would sit in and listen as we explored the magic of radio. On our first day the class measured and built a 40 meter dipole, tossed it out the window, stretched between a couple of anchor points, and proceeded to talk around the country. In the second year of our program, the ARRL provided a Big Project grant and a local club, the Bullitt ARS (<http://ky4ky.com>), provided sponsorship. Several local amateurs provided a tower and Yagi to complement the antennas that came with the ARRL grant.

As the program progressed, the students participated in fox hunts; the School Club Roundup (winning the middle school category one year); building antennas, and even venturing into Earth-Moon-Earth (EME) contacts, a project still in the works.

### Super Side Benefits

My expectations were high from the beginning. While the number of new hams has not met expectations, the cursory benefits have been exceptional. Parents and teachers have been exceptionally supportive. It would have been outstanding to have a teacher or two earn their own



*Students from St. Aloysius school radio club at the end of a fox hunt. The fox was in the hole!*





*St. Aloysius school radio club from year two; five are now licensed hams.*

licenses, but the other forms of support were evident and gratifying.

For five years, any student that earned their amateur license would automatically improve their science grade one full letter grade. The Spanish teacher, Mr. Miller, enjoyed speaking with South American hams, via third party rules, in Spanish, and the kids would chime in occasionally as well. One child started as a fourth grader with a bit of a speech impediment. Her activities on the air and in the classroom gave her the confidence to overcome the speech issue.

The side benefits of amateur radio in the classroom are phenomenal. These students learned the art of conversation. They learned “where in the world is that place” first hand. They learned that “foxes” can be hiding in an old mouse case hidden in the computer lab

or in a hole by the baseball field. They were regaled with stories from hams as young as 97 and met other students around the country. These students were challenged with math well beyond their grade level and discovered how magic wireless can really be.

## End of an Era

Realizing that the first kids in our first class will be graduating from college this year and that St. Aloysius is closing, due to rising costs and decreasing enrollment, has given me cause for reflection. Looking back on some of the successes from radio in the classroom would take more pages than allowed here. But, this might give you an idea of the role of radio in our classroom: This year, one of the original students will graduate with a

major in broadcasting and two will graduate as engineering majors; all three attending on academic scholarships.

One of the more studious girls in the class will be attending MIT this fall and another to Yale on full academic scholarships. So many of the kids who ventured through the ham radio class have blossomed into confident young adults, able to effectively communicate. While most of these radio class kids did not achieve their license during class time, the seed has been planted, and like so many others may rediscover radio years down the road.

For now, the St. Aloysius Radio Club has to relegate itself to a social networking site. All the guys and girls will be attending different schools in the fall, but all wanted to stay in touch and keep learning about radio. It was heartwarming and wrenching, during the last day of radio class – all the kids wanted the program to come to their ‘new’ schools. And, in usual ham radio fashion, the old timer has extended the hand of friendship to the newcomers, and said, “Whatever you need, just ask.”

If you are interested in getting amateur radio in the classroom, start by introducing the staff, administration and kids to the magic of radio. Have all your ducks in a row. Be able to explain the possible costs and the benefits, especially the side benefits. And, be prepared to put a lot of your heart, soul and time into the process, for if you truly love something and want it to continue, you must be willing to train your replacement.

**MT**

*About the Author:*

*Buddy Sohl KC4WQ, first licensed in 1979 as KA4JMX, upgraded to Advanced 1980 as KC4WQ and then Amateur Extra 1981. Active on bands 160 meters through 70 cm, primarily CW or digital, he is a Life member of the ARRL, Volunteer Examiner, Past President Bullitt Amateur Radio Society, Trustee KY4KY and W4KBR. He is a retired Air Traffic Controller after 25 years service at Memphis ARTCC and Standiford ATCT. He may be reached at kc4wq@arrl.net.*



*Students from St. Aloysius school radio club discuss radio theory in class.*



*KI4JAO operating during Kentucky QSO Party as KY4KY.*



# 2012 SCR Fall Semester Contest

By Ken Reitz KS4ZR  
(QSLs courtesy the author)

In many ways the **School Club Roundup (SCR)** is the opposite of what you've come to expect from an amateur radio contest. While most contests take place over a given weekend, SCR operates only during school hours, on weekdays, over the course of a week.

This year the SCR Fall Term begins October 15 at 1300 UTC and ends October 19 at 2359 UTC. Stations are allowed to operate no more than six hours in a 24 hour period and may not operate more than 24 hours total during the 107 hour event.

## Not Your Typical Contest

While most amateur radio contesters pride themselves in the speed with which they cycle through contacts, SCR is more about content; taking the time to actually talk with the students in their classrooms. Some SCR contacts can take 5, 10 even 15 minutes to complete. And, while most amateur radio contesters are seasoned contest veterans, many SCR operators have never worked a contest. Their ages may range from first grade to college graduate-level, and students can be from both public and private educational institutions. Veteran hams have to adjust their on-air subject material to the student's level; just don't talk down to them!

SCR is focused on schools contacting other schools, for which they are awarded more points, but individual operators not affiliated with a school are also encouraged to participate though they are given fewer points per contact. While many schools have permanent amateur radio stations in a dedicated classroom, others are temporary stations activated only during SCR.

Best practice is to let the school operators set the pace. If they are operating in real

**MONTANA**  
GALLATIN COUNTY

# K7BZN

| CONFIRMING QSO WITH | DATE |       |      | UTC  | MHZ     | RST | MODE 2-WAY |
|---------------------|------|-------|------|------|---------|-----|------------|
|                     | DAY  | MONTH | YEAR |      |         |     |            |
| KS4ZR               | 15   | 2     | 12   | 2011 | 21.345R | 556 |            |

thanks!!

PSE QSL  FNX QSL

**Chief Joseph Middle School**  
4255 Kimberwicke  
Bozeman, MT 59718

*K7BZN Chief Joseph Middle School, Bozeman, Montana, the easiest way to add Montana to your WAS list.*

contest mode, don't rag-chew; do the required exchange and move on. Remember, for many of these students, the only operating time they may get is during the time they're operating SCR.

Usually, in the case of elementary schools, the teacher is the control operator and will pick one or two students to ask questions in a single exchange. Be patient with the handoff from the teacher to the students, sometimes the kids are mic-shy and the ensuing dead-air can complicate the exchange. Remember to say, "Over" when you're finished talking, most students are expecting a cue to reply. Also, remember that there may be an audience of 20 or 30 other students listening to the exchange.

Don't assume that all SCR operators are novices at amateur radio. Many SCR operators have earned their own licenses (some hold General and even Extra Class licenses) but are operating under the school's call sign. Regardless, you'll find that most SCR operators are extremely polite and have been well schooled in on-air protocol. All SCR student operators should be accorded the same respect you'd give any fellow operator.

Old-timers need to be polite, too, if SCR operators seem to infringe on "their frequency." Remember, the FCC doesn't assign amateur radio frequencies to nets, no matter how long they've laid claim to a specific frequency. As mentioned, most SCR ops will respond positively to requests to move a few kHz to accommodate a daily net. Still, SCR is only five days, twice a year; you can have the frequency the other 50 weeks.

Try to work as many schools as you can. It'll give you a little more faith in this up and coming generation and you may be amazed at the capabilities these students possess. I once had a PSK31 contact with a seven year-old at

an elementary school in Portland, Oregon.

Throughout the years you'll recognize schools and their sponsors/trustees and you'll enjoy seeing how school club stations grow. If you've never worked a contest before because you've been turned off by the "5-9 QRZ" contest style, you'll enjoy SCR with its easy-going pace and the chance to talk with students who are actually interested in amateur radio.

Most official school clubs have photos of their stations, teachers and students which may be seen on <http://QRZ.com> along with URLs directing you to separate home pages maintained by the trustee of the school club itself. In addition, many school clubs have their own Facebook pages.

## Scoring Modes and Frequencies for SCR

As with most contests, the WARC bands (12, 17, 30 and 60 meters) are not used for SCR. Though some VHF frequencies are used, primarily 2 meter and 6 meter Single Side Band simplex or possibly operating amateur radio satellites, repeaters are not used for SCR.

In addition to the above modes, look for school stations on PSK31 and RTTY in the usual digital sub-bands of the above amateur radio bands; they'll usually send "CQ SCR" followed by the school's call sign. Complete rules for operating SCR can be found here: [www.arrl.org/school-club-roundup](http://www.arrl.org/school-club-roundup).

The exchange is straightforward. According to SCR rules, you must exchange your call sign; signal strength (RST); class (whether you are an "Individual", "Club" or "School"); U. S. state, Canadian province/territory or DXCC country/entity. Multi-operator group stations must choose one call sign to use for the whole operating period. Over the years I've found it hard to work DX schools because band conditions to DX regions during school hours are not necessarily cooperative. Still, I've worked schools and colleges in Europe and Canada in previous SCR's, so it can be done.

Stations may be contacted once for SSB and once for digital modes (for purposes of this contest CW, PSK31, RTTY or any other digital mode count as a digital contact). The good news for contesters is that SSB contacts count as one point and any digital contact counts as two points. So, by hanging out on the PSK31 or RTTY frequencies, it's easy to rack up a decent score. The bad news is that,

## K5LMS

Lampasas Middle School Youth ARC; 902 S. Broad, Lampasas TX 76550  
Sponsors/control operators: Gene Case KUSC, Gordon Thornton WSGFR



| QSO with | Date    | UTC  | Band/mode | Power out | Report |
|----------|---------|------|-----------|-----------|--------|
| KS4ZR    | 2/13/12 | 2131 | 20m/SSB   | 100w      | 59     |

*K5LMS Lampasas Middle School, Lampasas, Texas, one of 27 Texas schools with amateur radio in the classroom.*



for purposes of this contest, the U.S., Canada, Alaska and Hawaii do not count as separate DX entities; you'll have to contact Mexico, the Caribbean, South America, Europe or Asia to claim DX points.

You can submit your SCR logs electronically via the formats specified at the SCR homepage listed above. But, don't expect a quick reply to your submission. SCR logs

are examined carefully and it will be months before winners are announced. As you can appreciate, the students find the competition challenging and those who place in the top categories will vigorously defend their position. It's a friendly, but serious, competition for the schools.

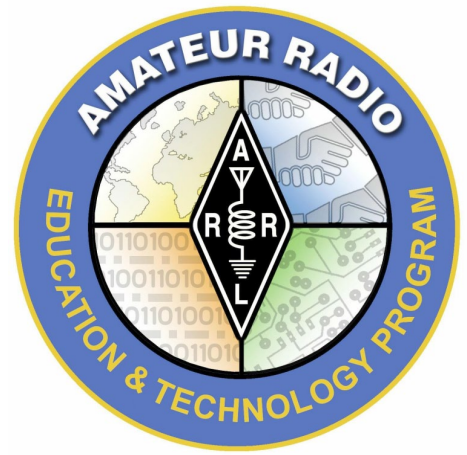

## QSLing the Schools

Schools don't have a lot of money for QSLs and postage. As with everything else connected to SCR, costs are often paid by the teacher/trustee. Still, collecting QSLs is a significant part of each club's activities and a very active school club can rack up a lot of postage. You can help defray such costs by including an SASE with your QSL.

Most club QSL addresses are often in care of the school amateur radio club at the school's street address. But, many others, particularly if the station is activated only for SCR, will be the home address of the teacher/trustee. The SCR operators will let you know the QSL route and whether or not they prefer an SASE. Some schools pride themselves in being able to raise the funds to pay for their own postage.

As with final results of the contest, expect a fairly lengthy wait to receive your SCR-related QSL cards. They're usually processed by the student operators, who often design and

print the cards themselves. The operator who worked you will usually fill out the QSL (the card I got back from the elementary school student operating PSK31 was nicely decorated in crayon and remains one of my all-time favorite QSLs). There's a great satisfaction in seeing another youngster embracing the hobby we all enjoy so much.

**MT**

### Recommended SCR Frequencies (kHz)

| Band | SSB (kHz)     | CW            |
|------|---------------|---------------|
| 160  | 1855-1865     | 1800-1810     |
| 80   | 3850-3880     | 3530-3540     |
| 40   | 7225-7255     | 7030-7040     |
| 20   | 14,250-14,280 | 14,030-14,040 |
| 15   | 21,300-21,330 | 21,130-21,140 |
| 10   | 28,440-28,460 | 28,130-28,140 |

**Burr and Burton Academy**  
Amateur HAM Radio Club

To Radio: *KS4ZR*  
Date: *2-14-2012*  
UTC: *20:07*  
Band: *20 METERS*

Sig RST: *555* SSB/CW  
FREQ: *14.266* MHz  
Transceiver: *TS-57K*  
Antenna: *94 FT DIPOLE*

Remarks: *KEN TAKI 4 THE CONTACT... 28 K4BBS*

**K1BBS**  
57 Seminary Ave. Manchester, Vermont 05254 U.S.A.  
Burlington County 05254 VERMONT  
PSE QSL TNS

**K1BBS Burr and Burton Academy, Manchester, Vermont: A private academic high school founded in 1829.**

**BLOOMINGTON HIGH SCHOOL SOUTH**  
AMATEUR RADIO CLUB

**K9SOU**

1965 S. Walnut Street  
Bloomington, IN 47401  
Monroe County - Grid: EM69rd  
www.mccsc.edu/~nrapp/ham

**K9SOU Bloomington High School South, Bloomington, Indiana. Last year they came in #4 in the fall term SCR.**

**K4WBM**  
WILLIAM BYRD MIDDLE SCHOOL  
AMATEUR RADIO CLUB  
2910 WASHINGTON AVENUE  
VINTON, VIRGINIA 24179  
AN ARRL BIG PROJECT SCHOOL

| CONFIRMING QSO WITH ARS | MONTH      | DAY       | YEAR        | TIME UTC    |
|-------------------------|------------|-----------|-------------|-------------|
| <i>KS4ZR</i>            | <i>FEB</i> | <i>16</i> | <i>2011</i> | <i>2005</i> |

| FREQ MHz     | RST       | MODE 2 WAY | RIG          | ANTENNA      |
|--------------|-----------|------------|--------------|--------------|
| <i>7.219</i> | <i>59</i> | <i>SSB</i> | <i>FT990</i> | <i>10W V</i> |

DRANKE COUNTY VA GRID EM69th 14V 74009 DEC 061 73M

**K4WBM William Byrd Middle School, Vinton, Virginia, sister station to WB4HS (William Byrd High School). WB4HS had little difficulty getting their station approved by the administration: the principal is a ham!**

**K3FBI**

**K3FBI: The FBI has a school? Yes! And, the FBI Amateur Radio Association is always active in SCR. You can bet this is one QSL schools like to put up on their wall! (Courtesy: Author)**

**AMATEUR RADIO AND YOUR LOCAL SCHOOL**

Carole Perry WB2MGP, a veteran of 30 years teaching amateur radio in the New York City public school system, once wrote in an *MT* article, "You don't have to reinvent the wheel when it comes to starting an amateur radio club at your local school." There are a great number of resources available to anyone wishing to start such a program.

According to the ARRL's list of Education and Technology Program (ETP) schools, there are some 500 school clubs throughout the U.S. This list, compiled in 2011, while the latest available, is incomplete and doesn't list the non-ARRL affiliated schools, private clubs (such as Boys and Girls Clubs which may have amateur radio after-school programs), or those students who are homeschooled by parents who are also hams.

Schools, from elementary to college graduate level, with active amateur radio programs are found from Alaska to Florida, Maine to Hawaii and every state in between. The best way to begin your quest to start an amateur radio program in a school near you is to study the resources available here: [www.arrl.org/amateur-radio-in-the-classroom](http://www.arrl.org/amateur-radio-in-the-classroom). This web site will direct you to the League's ETP and the Teacher's Institute on Wireless Technology; show you how to apply for ETP grants; and show you how to get involved with Amateur Radio on the International Space Station. This web page also has ideas for developing class lessons as well as offering kits and projects you can use in your classroom. There are also very

useful tips on how to approach school administrators on the subject of bringing amateur radio to local schools.

If you're a science teacher and a ham, the site has many ideas for incorporating science and amateur radio in your daily classroom schedule. Some ideas include discussion and demonstration of RF-ID technology; robotics; receiving and interpreting satellite telemetry; using GPS and APRS systems to track high-altitude balloons; building and soldering electronic kits; making wire or aluminum tubing antennas – the list is impressive.

Starting such an in-school amateur radio program is best done as a group effort. As Ronny Risinger KC5EES, teacher at the Liberal Arts and Science Academy in Austin, Texas notes, "It's no good starting a program only to have the teacher or trustee burn out after a few years." As seen in the two examples in this issue, successful programs depend on the help of a local club whose combined skills, experience and finances can help the program develop and mature.

The ARRL announced in late June this year that eleven schools received ETP grants in equipment and resources valued at more than \$16,000. Since the program's inception, more than 590 schools have received such grants. So, the next time your local club is considering a new direction or program, ask the group to consider starting an amateur radio club in a local school. You may be surprised at the results.

-- Ken Reitz KS4ZR



# A Quest to Find the Disappearing Sunspots

By Russ Steele KF6TAR

*This article is based in part upon work by William Livingston and Matthew Penn writing for the National Solar Observatory which is operated by the Association of Universities for Research in Astronomy (AURA) under a cooperative agreement with the National Science Foundation. Any opinions, findings, and conclusions or recommendations expressed in this material are those of the author and do not necessarily reflect the views of the National Science Foundation.*

**W**hen I bought my first shortwave radio I was unaware that sunspots played an important role in radio propagation. After my retirement from the Air Force and from my second career in business as a concept developer for TRW, an aerospace company, I started working on my bucket list. One of the items on that list was to become an amateur radio operator. I studied for my Technician Class ticket, took the test, and earned the call sign KF6TAR.

It was a combination of my interest in amateur radio and a TRW project to bid on an upgrade to the Air Force's Solar Observatories around the world, that accelerated my interest in amateur radio astronomy and sunspots. Studying the 11-year sunspot cycle, I understood that the presence or absence of sunspots could have an impact on the earth's climate, but more importantly to hams and shortwave listeners, a significant impact on radio propagation.

I recently also found that some scientists think that sunspots may soon vanish for a generation or more, cooling the earth and creating years of radio silence. Needless to say, I wanted to know more.

## Early Radio Monitoring

In the early 1950s my mother was the bookkeeper at our small town radio and TV store and I often admired a Hallicrafter S-53A receiver in the display case at the store. The storeowner let me buy it on a lay-away plan. I do not remember how much the radio cost, but it took three paychecks from my Saturday job as an intern at the Empire Mine Engineering Office in Grass Valley, California to pay for it.

The S-53 was a general coverage receiver, covering 5 bands from .54 MHz to 39 MHz and 48-54.5 MHz. I hung a long wire in the oak tree outside my window, and listened to stations well into the night, mainly AM stations as the shortwave bands were very quiet. I was rather disappointed in my radio purchase. Expecting more stations and more excitement on all the bands, I was unaware that it was during a solar minimum when a quiet sun limited some band openings.

Thinking that my quiet receiver was due to my limited long wire antenna, I constructed an elaborate antenna array on the roof, much to my mother's consternation. She was sure I was going to fall off the roof and break some bones.

However, my new antenna farm and deep ground stake did not provide much improvement on the higher shortwave bands. I wanted to hear the world, but it seemed to be missing. When I went into the Air Force, I left my S-53 at home, and a renter stole it from my parent's house.

After completing electronics warfare training at Kessler Air Force Base in Mississippi in 1961, I was stationed at Loring Air Force Base. Living in the bachelor officers' quarters, I was looking for something to do on those long winter nights in Northern Maine and missed having a shortwave radio. With time and interest I decided to build my very first Heath Kit, the GC-1A Mohican.

The Mohican was Heath's first all transistor general coverage shortwave and broadcast receiver. I wanted a portable shortwave receiver I could take with me wherever I was stationed. It included a calibrated band-spread for ham bands and a BFO for copying code and Single Sideband (SSB) voice.

I was never very satisfied with the receiver; it had a lot of audio distortion that I could not eliminate with my limited experience and available test equipment. Shortly after I finished building the radio, my spare time turned to a young lady who I met when she visited the Air Force Base. I soon discovered it was more fun writing letters to her at night than searching for shortwave stations on a radio that did not work very well. She is now my wife of 49 years.

## The Vanishing Sunspots

Now my interest in sunspots is related to long-term climate change. In 2004, I became interested in climate change and the role that sunspots might play in influencing temperatures here on earth. While studying sunspots and their impacts on the climate, I came across a paper by William Livingston and Matthew Penn titled, "Sunspots May Vanish by 2015."

This paper was published in 2008 and it got my attention not only in terms of climatology but also as an amateur radio operator. If the sunspots vanished, it would have an impact on the hobbies of radio monitoring and amateur radio, especially those hams interested in making long-range contacts.

Livingston and Penn are researchers at the Kitt Observatory, 40 miles south west of Tucson, Arizona, where the McMath-Pierce Solar Tele-

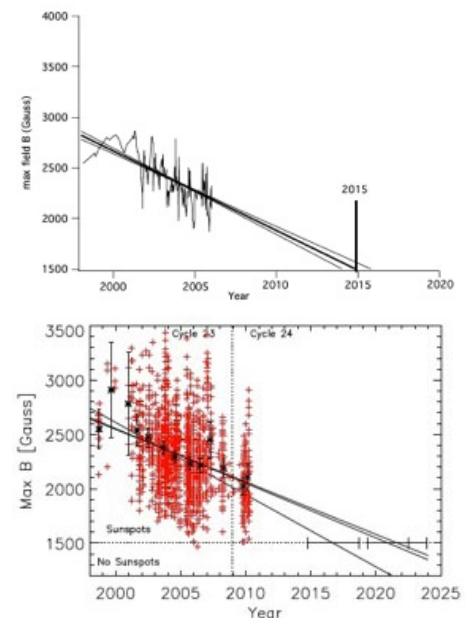

*"Measurements of the total magnetic field strength at the darkest location in umbrae and pores as a function of time. The crosses show the individual measurements, the asterisks show annual bins. Three linear fits are shown: the bottom fit line fits data from 1998-2006 as done in our 2006 paper. The top line fits all the data from Cycle 23, and the middle line fits all of the data." (Figure 1, Long-term Evolution of Sunspot Magnetic Fields; text from a paper by William Livingston and Matthew Penn)*

scope dominates the view from the mountaintop. In a subsequent 2009 paper, Penn and Livingston moved the date they think that sunspots would disappear from 2015, which is only three years away, to a period between 2016 and 2020, still not that far way. This second paper included more observations, over 13,000, which refined the declining sunspot data, but also broadening the window of probability.

How did Livingston and Penn determine the spots are going to disappear? They used the McMath-Pierce Solar Telescope that is equipped with a powerful spectrometer. Using these tools they made some long-term observations of sunspots starting in 1990, focusing on three areas:



Spectroscopic changes in temperature sensitive molecular lines; changes in the strength of the magnetic fields surrounding the sunspots, and changes in the sunspot umbrae, the darkest region of a sunspot.

All three measurements showed consistent trends in which the darkest parts of the sunspot umbra become warmer by about 45 degrees Kelvin per year, the strength of molecular absorption lines decreased, and the magnetic field strengths decreased by 77 Gauss per year.

These changes were determined to be independent of the normal 11-year sunspot cycle. Using the data collected from 1990 to 2005, Livingston and Penn constructed a linear extrapolation of the three trends. The linear plots suggested that sometime around 2017 very few sunspots would be visible on the sun. The question is; for how long will they disappear?

## Visiting the Solar Observers

I wanted to learn more about the solar observations and scheduled a vacation trip to Arizona and the Kitt Peak Observatory with my wife Ellen, my friend George and his wife Jo Ann. George knew one of the guides at the solar observatory from his days in the Army and arranged to meet him for a tour and lunch. We were going to get an inside look at how solar observations are made and some insight into the process. However, a late spring snowstorm threw a wrench into our plans.

On the appointed day we visited the observatory, taking care not to slip and slide in the snow covered road as we approached the summit at 6,875 Feet. There was about a foot of snow on the ground and snow banks in the parking lots. It was only later that we learned our insider friend had canceled due to the snow and the slippery roads.



*Author standing at the entrance to the Kitt Peak McMath-Pierce Solar Telescope. (Photo by Ellen Steele)*

The McMath-Pierce Solar Telescope was dedicated in 1962, and, is one of the largest solar telescopes in the world, with an unobstructed-aperture of 1.6 meters. Permanent instruments include a dual grating spectrograph capable of extended wavelength coverage (0.3-12 microns), a 1-meter Fourier Transform Spectrometer for both solar and laboratory analysis, and a high-dispersion stellar spectrometer.

Important discoveries include the first mea-



*The top of the observing tube is crowded with instruments to measure the solar images. Dr. Livingston's instruments are not shown in the photo, according to our guide. (Photo by Ellen Steele)*

surement of Kilogauss magnetic fields outside sunspots and the very weak intra-network fields; first high resolution images at 1.6 and 10 microns. And, I would add, the discovery that sunspots might soon disappear. The Association of Universities for Research in Astronomy operates the National Solar Observatory under an agreement with the National Science Foundation, which is the main funding source for telescope operations.

It was this sophisticated observing tool that Dr. William Livingston used to measure the magnetic fields on the Sun and give a pictorial representation of the variations in strength of the magnetic field surrounding the sunspots. He and his team did this by exploiting the Zeeman Effect. This is where the science gets a bit complicated, so I have provided an explanation of the Zeeman Effect in the sidebar.

The research team's observations of the magnetic field were plotted on a graph. It suggested that when average field strength reached a threshold value of about 1500 Gauss it would be very hard to see sunspots by about 2017. An analysis of the umbra continuum brightness

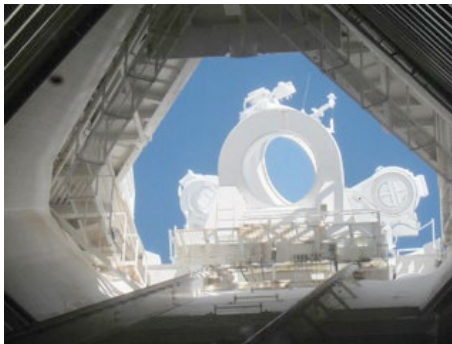

*Heliostats which collect the sun for observation. There are three mirrors, one large one in the center and two smaller ones on each side, allowing multiple observations. (Photo by Ellen Steele)*

showed another linear trend and extrapolation showed the umbra brightness would be equal to the quiet Sun brightness at about the same year. The conclusion: the sunspots we now can see will be invisible.

Finally, the molecular line depths showed a decreasing strength with time, and again the trend suggested that molecular absorption lines would disappear from the average sunspot umbra near 2017. Not good news for those who are counting on the sunspots to create unexpected band openings and radio amateurs counting on arctic northern lights for long distance VHF band openings.

## Disappearing Sunspot History

Have the sunspots disappeared before? Yes, they have. During the period between 1645 and 1715 sunspots vanished. During the period from 1600 to about 1645 the astronomers of the day observed very few spots, as opposed to thousands of spots observed in a single year in modern times, with much more powerful observing tools.

When comparing historical observations in the 1600s and 1700s with modern observations, one has to be cautious. Scientists may see more spots today than historical observers could because early observers had crude telescopes and no recording equipment. They projected the Sun's image on paper, and drew a representation of the dark spots on the paper. Other observers just noted the existence of spots and the aurora that was associated with sunspots in logs, journals, and letters.

Researchers used these drawings, logs, journals, and letters to construct a comprehensive sunspot history starting in 1600, when observations started soon after telescopes were invented.

The most dedicated solar observers were German and French astronomers. In Germany the most active observer was Johannes Hevelius (1611-1687). In France a systematic solar observing program was developed under the direction of Jean Dominique Cassini (1625-1712) at the newly founded Observatoire de Paris – first by Jesuit Jean Picard (1620-1682) and then by Philippe La Hire who carried out the bulk of the observations. These dedicated astronomers from about 1645 to 1715 observed very few sunspots, and when they were present it was a noteworthy event recorded in logs and letters.

There were several periods after 1600 when some spots were observed, but they seem to have vanished from 1644 to 1660. Some more feeble spots were observed up to 1665, then no spots until 1671. The longest period of no observed spots was from 1675 to 1700, a span of 25 years. A period often referred to as the Maunder Minimum.

The Maunder Minimum was named after solar astronomer Edward W. Maunder (1851-1928) who studied how sunspot latitudes changed over time. The period Maunder examined included the second half of the 17th century. He published two papers in 1890 and 1894, citing earlier research by Friederich Wilhelm Gustav Spörer, noted for his studies of sunspot cycles. Spörer was the first to note a prolonged period of low sunspot activity from 1645 to 1715.



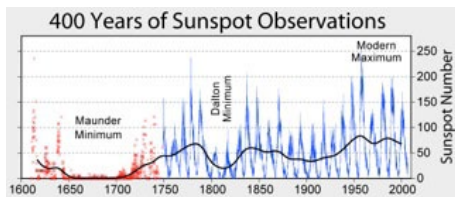

*“A linear fit to observed magnetic fields extrapolated to the minimum value observed for umbral magnetic fields; below a field strength of 1500G as measured with the Fe I 1564.8nm line no photospheric darkening is observed.” (Figure 3, Sunspots may vanish by 2015; text from a paper by William Livingston and Matthew Penn)*

When examining the historical reconstructions, it appears that grand minimums happen on a regular cycle of about 200 +/- 20 years. Given that historical schedule, we are due again for another grand minimum. The open question is: Will another Maunder style minimum happen? Will all the spots disappear for a whole generation?

In addition to U.S. scientists, Russian scientists also see a 100-year cooling cycle resulting from diminished sunspots. Dr. Habibullo Abdussamatov, head of the Russian segment of the International Space Station and head of Space Research of the Sun Sector at the Pulkovo Observatory of the Russian Academy of Sciences, led a team of Russian scientists who took an interest in J. A. Eddy’s paper on the Maunder Minimum.

With Eddy’s paper as a starting point, the Russian scientists examined historical records and concluded there is a quasi 200-year cycle of global cooling over the past 7,500 years and that this cooling correlates to times of sunspot minimums similar to the Maunder Minimum.

The Maunder Minimum is associated with the Little Ice Age when China, Europe and North America went into an extended deep freeze during which Alpine glaciers extended over valley farmland and crushed villages; sea ice crept south from the Arctic creating huge icebergs in the shipping lanes; the famous canals in the Netherlands and rivers in England froze regularly, and long term droughts in China caused huge political upheaval as millions starved.

## Sunspots Today

Where are we today? What is happening on the Sun? Solar Cycle 24 is approaching a maximum, which is much lower than originally projected by the prediction team at NASA’s Marshall Space Flight Center, led by Dr. Hathaway. This team originally thought Solar Cycle 24 was going to be the strongest yet, but over time they kept lowering the forecast. Here is the current estimate:

As you can see in the graphic below, not all solar scientists agree that all spots will vanish. Dr. Hathaway and the NASA team see spots out to about 2020 when Cycle 24 comes to an end. History has shown that forecasts by the NASA team have required continual adjustments, as the Sun failed to follow NASA’s models. It has proven very difficult to predict what the Sun is going to do, and previous failures are constrain-

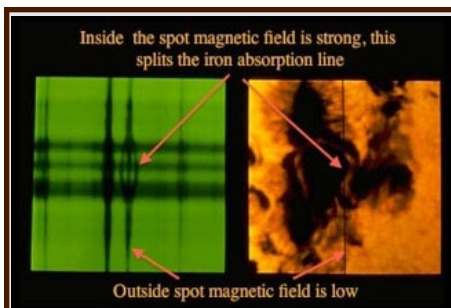

*Courtesy: the National Optical Astronomy Observatories, annotations by the Author.*

In a sunspot, the spectral lines that are normally at a single wavelength become split into two or three components in the presence of a magnetic field, depending on the orientation of the field with respect to the line of sight. The separation of the outermost component is proportional to the strength of the magnetic field in this sunspot about 0.4 Tesla, or 4,000 Gauss. The components also have a circular or plane polarization, and the circular polarization, or orientation, indicates the direction, or polarity of the longitudinal magnetic field.

ing the willingness of solar scientists to step out and predict what Solar Cycle 25 will look like.

Once again, we will have to rely on Livingston and Penn. They have provided the first hard estimate of Solar Cycle 25 amplitude based on their physical model. Solar Cycle 24 is estimated to peak at about 66. The estimate for Solar Cycle 25 is about 7. This would make it the smallest solar cycle in over 300 years.

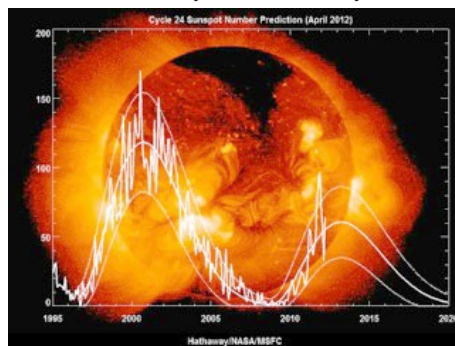

*The current prediction for Sunspot Cycle 24 gives a smoothed sunspot number maximum of about 61 in the Spring of 2013. The current predicted size makes this the smallest sunspot cycle in about 100 years. (Graphic Credit, NASA Marshall Space Flight Center)*

Some solar scientists have indicated we may be on the cusp of another grand minimum when sunspots could vanish for 20-30 years. Others are not so sure. If Solar Cycle 25 predictions are valid, and we are entering another grand minimum like a Maunder, then sunspots could vanish for long periods or be extremely low for up to a hundred years or more.

If the spots disappear, it will have a long-term impact on long distance HF and VHF communications. It could change the hobby of radio monitoring for generations of future listeners, giving us old hands the opportunity to brag about the good old days when there were sunspots.

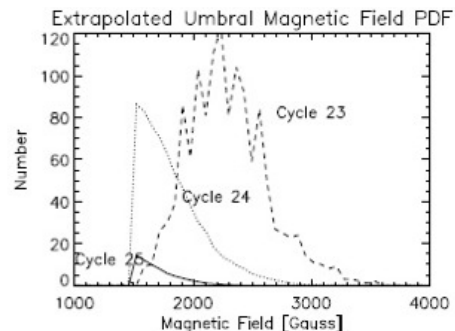

*This is Figure 2 from a paper by Livingston and Penn showing their IR measurements of sunspots during Cycle 23 and, based on their assumptions, have estimated the levels for Cycle 24 and 25. They estimate that Cycle 24 will peak with a sunspot number of 66 and cycle 25 will peak with a sunspot number of 7.*

## USEFUL RESOURCES

National Solar Observatory Home Page ([www.nso.edu/](http://www.nso.edu/))

The Livingston-Penn paper ([www.nso.edu/press/SolarActivityDrop](http://www.nso.edu/press/SolarActivityDrop))

Live Image of the Kitt Peak, McGrath-Pierce Observing Room. (<http://nsokp.nso.edu/mp>)

Kitt Peak Observatory Home Page ([www.noao.edu/kpno/](http://www.noao.edu/kpno/))

Daily Solar Updates at Spaceweather.com ([www.spaceweather.com/](http://www.spaceweather.com/))

NASA, Marshall Space Flight Center, Solar Physics Predictions (<http://solarscience.msfc.nasa.gov/predict.shtml>)

The K7RA Solar Update ([www.arrl.org/news/the-k7ra-solar-update-213](http://www.arrl.org/news/the-k7ra-solar-update-213))

**M<sub>T</sub>**

## GRE PSR-120

The backlit LCD display provides a giant frequency display, signal strength bargraph, memory channel number, active memory banks, and much more.

Looking for those unknown frequencies while on the road? Spectrum Sweeper automatically registers the activity and tells you the frequency while you listen. Service search and limit search also provide quick access to those unknowns.

Concerned about the weather? The PSR-120 has NOAA SAME/FIPS warning. Need CTCSS or DCS squelch? This scanner will decode or encode it for you!

Order SCN25

**\$109<sup>95</sup>**

plus \$19.95 UPS Ground Shipping

800-438-8155

828-837-9200

fax: 828-837-2216

WWW.GROVE-ENT.COM



**GROVE**



# Opposition and Clandestine Broadcasts Target Sudan and Darfur

By Steven Handler  
(QSL cards courtesy the author)

**S**udan is an African country that has seen more than its share of war and violence. Once governed by the British, it became independent at the end of 1955. However, a dispute erupted, leading to a 17 year civil war. In 1972 the Addis Ababa agreement ended the civil war, but the peace was short lived.

A little over ten years later, in early 2003, a rebellion in the western region of Darfur began. Despite ceasefire agreements and peace talks, violence continued and, in January 2005, a peace treaty was signed which agreed that southern Sudan would have autonomy for six years, after which they could hold a referendum on independence.

In 2005, with the civil war fighting quieting down, the neighboring country of Chad declared a State of war against Sudan. It was not until the beginning of 2010 that the two countries agreed to a ceasefire, ending the conflict.

In January of 2011, the referendum for independence for Southern Sudan was held, with the majority of the population voting to secede and create the Republic of South Sudan. Armed violence again broke out between Northern and Southern Sudan, resulting in peacekeeping troops being deployed to the area. On July 9, 2011 South Sudan formally became independent.

Against this backdrop of long term violence, the media within Sudan was perceived by many outside the country as being unable to effectively keep the population informed with fair and unbiased news reporting, so several entities outside the country stepped in to fill the void.

## Sudan Radio Service

Sudan Radio Service (SRS) began broadcasting on July 30, 2003, becoming Sudan's first independent broadcast provider of news and information. Their original one hour a day shortwave broadcasts grew into its current schedule of six hours per day of shortwave broadcasting as well as twelve hours a day on FM radio.

To reach as much of the potential Sudanese audience as possible, they broadcast in eleven Sudanese languages (Juba, Dinka, Zande, Moru, Nuer, Bari, Shilluk, Toposa, Fur, Masalit and Zagawa), as well as Arabic and English. Their varied programming includes news, educa-

**SUDAN RADIO SERVICE (SRS)**  
**FOR PEACE AND DEVELOPMENT**





Sudan Radio Service (SRS) is an independent broadcast provider of news and information. Listen to SRS on the radio or on the web.  
**Listen to 98.6 SRS FM in Juba, full-time everyday!**

**Contact Sudan Radio Service**  
C/o Education Development Center  
P.O. Box 425, Juba Southern Sudan Plot  
48 Block I Korok  
Text us at +2499917260017  
Thuraya: +882164339902  
Email: srs@edc.org/srs@sudanradio.org

**Shortwave Frequency schedule**  
From: October 31st to March 2011  
4-6am GMT: 13,720 kHz  
3-5pm GMT: 17,745 kHz 5-6pm GMT: 9,840 kHz

**SRS Darfur programming:**  
Saturday to Thursday  
4-5pm GMT at 11,785 kHz or 17,700 kHz

[www.sudanradio.org](http://www.sudanradio.org)

Dear Handler,

We are pleased to confirm your reception report of our programs. It has been checked and found to be correct.

| Date |         |      | Time          | Frequency  | Location |
|------|---------|------|---------------|------------|----------|
| Day  | Month   | Year |               |            |          |
| 09   | JANUARY | 2011 | 1607-1659 GMT | 17,700 KHz | USA      |

We appreciate your interest and hope you will continue to enjoy our broadcast.

For more information about Sudan Radio Service (SRS) log on to our website at [www.sudanradio.org](http://www.sudanradio.org). Again we thank you for listening to SRS!

Sincerely,  
Sudan Radio Service (SRS)

tional, music and entertainment features, and is produced by an all-Sudanese staff at their main offices in Juba (the capital of Southern Sudan), Nairobi, Kenya and a bureau in Khartoum, the capital of Sudan. SRS utilizes a network of Sudanese correspondents located throughout Sudan.



Miraya is a FM & SW network serving Sudan. It is a joint project of the Fondation Hironnelle - Media for Peace & Human Dignity, a non governmental organization of journalists based in Switzerland - and the United-Nations. The radio aims to contribute to the restoration of peace in the country by broadcasting independent, credible, and reliable news and programmes.

QSL for Steven Handler

We are pleased to certify your reception of STAR radio, Liberia

Date: on March 30, 2011  
Time: 1529 to 1550 GMT  
Frequency: 15710 KHz  
Signature: Mr Jean-Luc Mootoosamy, Miraya Program Officer

SRS is a project of Education Development Center, Inc., an international non-governmental organization which is supported by the United States Agency for International Development. SRS's goals and objectives include providing balanced news and information, becoming Sudan's premier independent provider of trusted news and information to the people of Sudan living both in Sudan and abroad. It aims to provide listeners with the tools to participate more fully in peace making, reconciliation and the development processes of Sudan, as well as building a corps of Sudanese journalists and media partners.

## Radio Miraya

In June of 2006, almost three years after the start of SRS, a second major broadcaster, Radio Miraya/Miraya FM, began operations. Currently broadcasting three hours each day to Sudan on shortwave, they also broadcast using an extensive network of twenty six FM transmitters inside Sudan. Funded by the United Nations Mission in Sudan (UNMISS), Miraya is operated by the Fondation Hironnelle, a Swiss non-governmental organization of journalists and professionals in humanitarian action.

Programs include news, current affairs, needs-based programming, interactivity, music and sports. Besides keeping the people

Fondation Hironnelle  
Avenue du Temple 19C  
CH-1012 Lausanne  
Switzerland



For more information : [www.hironnelle.org](http://www.hironnelle.org)  
[info@hironnelle.org](mailto:info@hironnelle.org)



informed, they want to be a tool for promoting pluralism, diversity and education and the forging of a national identity.

Miraya's core principles include fairness, accuracy and balance in their programming. They provide diversity with teams composed of staff from different ethnic groups, cultural backgrounds and religious beliefs. The multi-ethnic mix helps build an atmosphere of mutual respect and helps promote cultural diversity and peaceful co-existence. They are also trying to create and support local journalists and media within Sudan.

## Radio Dabanga

Toward the end of 2008, Radio Dabanga began its programming over shortwave radio for the Sudan and Darfur regions. It began as a project of the Radio Darfur Network, a coalition of Sudanese journalists and international media. It is operated by Free Press Unlimited and supported by international donors, humanitarian community organizations and local non-governmental organizations. Radio Dabanga claims over 2 million listeners and currently broadcasts via shortwave for two and a half hours per day.

To reach a wide audience they broadcast the news in Arabic as well as the local languages of Fur, Masaliit and Zaghawa. In addition to their 10 minute news program, they air 15 minute programs called "Topic of the Day," presenting both sides of an issue. A twelve minute program titled "Bissaraha" (Frankly Speaking) interviews a key person in Darfur. "Habaabkum Darfur," a 25 minute twice weekly program, features those living in displacement camps sending messages to their families. Other programs are also aired.

Radio Dabanga news is supplied by correspondents in Darfur and other locations in Sudan, with the central editorial team in Hilversum, the Netherlands.

Press Now was established in 1993 and has

a long history of promoting journalistic freedom in conflict zones and countries in transition. In 2011 Press Now merged with Radio Netherlands Training Centre and Free Voice, forming a new organization called "Free Press Unlimited." The operations directed to Sudan were, in part, a result of the restrictive media climate fostered by the government owning the country's radio and television stations and print media.

## Radio Tamazuj

The newest broadcaster is Radio Tamazuj, which began daily half hour broadcasts in January of 2012. Their target audience is the people of Abyei, South Kordofan, Blue Nile, Unity, Western Bahr El Ghazal, Northern Bahr El Ghazal, White Nile, Renk and the Nuba Mountains. The station's programs are broadcast in Arabic and Dinka. Radio Tamazuj is also an initiative of Free Press Unlimited and their shortwave program airs just before those of Radio Dabanga, using the same frequencies and transmitters sites.

All four of these shortwave broadcasters are working to provide the region with independent news, reporting and entertainment. In addition, there is an effort to train and encourage local journalists who, in the future, can take over providing the population with independent media reporting. The future will be the ultimate judge of their success.

## SUDAN RADIO SERVICE

Educational Development Center  
1000 Potomac St NW  
Washington DC 20007

Email: srs@edc.org or srs@sudanradio.org  
QSL: They have responded to email reception reports with a QSL letter

A-12 Season Daily Broadcasts

0400-0500  
11800 Darfur Programming via Dhabayya, UAE  
250 kW

13720 SRS Radio Programming via Dhabayya, UAE 250 kW

1500-1700  
17745 SRS Radio Programming via United Kingdom 250 kW  
1600-1700  
15500 Darfur Programming via United Kingdom 250kW

## RADIO MIRAYA/MIRAYA FM

c/o Foundation Hirondelle  
Avenue Du Temple 19c  
CH-1012 Lausanne, Switzerland

Email: info@hirondelle.org  
Web Site: [www.mirayafm.org](http://www.mirayafm.org)  
QSL: They have responded to reception reports by post with a QSL card.

A-12 Broadcasting Schedule

0300-0400 GMT  
11560 Khz via Simferopol, Ukraine 250 kW

## RADIO DABANGA

Witte Kruislaan 55  
1217 AM Hilversum  
Postbank 7676  
The Netherlands

Email Address: radiodabanga@yahoo.com  
Web Site Address: [www.radiodabanga.org](http://www.radiodabanga.org)

QSL: They have responded to reception reports by post with a QSL card.

A-12 Season Broadcasts

0430-0557 GMT Daily  
11650 via Santa Maria Galeria, Vatican 250 kW  
15400 via Talata-Volonondry using 250 kW  
15550 via Dhabayya, UAE using 500 kW

1530-1627 GMT Daily  
15150 via Talata-Volonondry using 250 kW  
15725 via Trincomali, Sri Lanka using 250 kW

## RADIO TAMAZUJ

Witte Kruislaan 55  
1217 AM Hilversum  
Postbank 7676  
The Netherlands  
Telephone: 0031 35 62 54 340  
Email: radiotamazuj@yahoo.com  
Web site: [www.radiotamazuj.org](http://www.radiotamazuj.org)

A-12 Season Broadcasts

0400-0427 GMT Daily  
11650 via Santa Maria Galeria, Vatican using 250 kW  
15400 via Talata-Volonondry using 250 kW  
15550 via Dhabayya, UAE using 500 kW

Notes:

- [1]: Broadcasting times: Radio Dabanga web site [www.radiodabanga.org/node/196](http://www.radiodabanga.org/node/196)
- [2]: Transmitter locations and technical details via the HFCC B-11 Frequency Schedule located at [www.hfcc.org/data/schedbybrc.php?seas=B11&broadc=PNW](http://www.hfcc.org/data/schedbybrc.php?seas=B11&broadc=PNW)
- [3]: Broadcasting times: Radio Tamazuj web site <http://radiotamazuj.org/en/page/frequencies>
- [4]: Broadcasting times for Sudan Radio Service [www.sudanradio.org/fimetable](http://www.sudanradio.org/fimetable)
- [5]: Miraya FM Broadcasting times: [www.hfcc.org/data/schedbybrc.php?seas=B11&broadc=MIR](http://www.hfcc.org/data/schedbybrc.php?seas=B11&broadc=MIR)



### SUPPORT RADIO DABANGA



Radio Dabanga is the only source of independent news available for the people of Darfur. For security reasons the station broadcasts from Hilversum in The Netherlands. The editorial staff are all Sudanese journalists, as well as correspondents and informants from Sudan and the refugee camps in Chad. Radio Dabanga now produces three hours of original programming per day, including a daily news bulletin that is broadcasted in the 5 local languages of Darfur.

Radio Dabanga does not take sides in the Darfur conflict. Its reports are based on journalistic best practice and provide a diversity of opinions. In this way, Radio Dabanga aims to give more hope and decrease uncertainty by informing the Darfuri. It also aims to reduce the distrust between ethnic groups and promote dialogue.

For our radio frequencies and more information, please visit our website [www.radiodabanga.org](http://www.radiodabanga.org)

You can also directly support Radio Dabanga by donating any amount to **IBAN NL28 INGB 0657.1138.91**, Friends of Radio Darfur, Hilversum. Or you can send this card to your family and friends. Thank you!

Thank you for the reception report!  
All the best, Press Now.

Steven Handler

---

USA





## Adapting an AOR8000 to Change

**C**hange is a constant presence in the radio industry. As much as hobbyists might like things to stay the same, technology advances and requirements evolve, leading to new equipment, new regulations and new procedures. This month we take a look at the current usefulness of an older scanner and examine some past and future changes to a few public safety radio systems.

### ❖ AOR AR8000

*Dan, How effective is an AOR AR8000 for monitoring public service bands now?*

*When this scanner first came out it in the early 1990s it was touted as quite advanced, but is it any good at monitoring today's communications of police, fire, emergency services etc., considering the advances which have been made over the past 15-20 years?*

*Aren't many of these agencies now using digital transmissions that are impossible for the AR8000 to receive?*

*What is this scanner still good for and what is it no longer good at?*

*Many thanks in advance for your expertise in answer these questions.*

*Joe in California*

The AOR AR8000 is a 1994-era handheld scanner that has an excellent reputation as a sensitive and selective receiver. It is capable of tuning anywhere from 500 kHz up to 1900 MHz with no gaps and has sufficient memory to store 1000 individual frequencies in 20 banks. It has a four-line alphanumeric display and scans at 30 channels per second. The hardware design of the scanner also has an internal connector block on the RF board that accepts add-on printed circuit cards, including a DS-8000 speech inversion board that could undo the analog voice scrambling technique of the time.



In 1997 the Federal Communications Commission (FCC) revoked the AR8000's certification, due to the ease with which it could be used to listen to cellular telephone calls. The long, sad history of cell phone lobbying and Congress includes a restriction

on the sale of scanners that are capable of monitoring the frequencies used by analog cell phones. This restriction is enforced by the FCC during the regulatory certification process, a necessary legal step for any company to market and sell a radio in the United States. This restriction remains in force today, despite significant changes in cellular technology, and prevents U.S. consumers from easily purchasing truly full-coverage scanners.

One of the most useful features of the AR8000 is computer control. AOR documented a set of software commands that allow an external device to tune the radio, load and store frequencies in memory, and perform other useful actions. Not only does this eliminate the need to tediously program each frequency via the keypad, it also makes it possible for a frequency counter to control the scanner.

A popular combination was the AR8000 with an Optoelectronics Scout, a battery-powered handheld frequency counter. The Scout would detect a nearby transmission and instruct the AR8000 to tune to the detected frequency via the "Reaction Tune" data interface. Today such a capability comes with many newer scanners, but fifteen years ago this was a great leap forward for hobbyists.



The computer control port also made available capabilities that we take for granted today, including the ability to "clone" a radio by automatically copying memory contents from one scanner to another.

A number of software packages provide a user interface for the computer control features. You can find several such programs, along with documentation and comments, in a Yahoo group dedicated to the AR8000. Go to <http://groups.yahoo.com/group/ar8000> and join up. The "Files" section contains software, manuals, and related documentation that will help you to see

what can be done with the scanner. A number of web sites also provide programs and information that might be worthwhile.

Besides a lack of modern tracking and digital features, there are a few other drawbacks to the AR8000. The case is made of somewhat flimsy plastic, making it a necessity to use a protective case. The stock antenna that shipped with the unit is not a particularly good performer, so many owners bought after-market antennas to improve reception on their favorite bands.

Over time, some units developed a problem with the audio section that was referred to as "sputtering squelch." The symptom was a rapid interruption of the audio that made the scanner unusable. For those handy with a soldering iron, a minor modification to the circuit board involving the replacement or addition of a capacitor corrected the problem.

As a stand-alone unit, the AR8000 is not capable of monitoring the trunked and digital public safety networks that are so prevalent today. It lacks the circuitry and firmware of modern scanners that allow automated trunk-tracking and monitoring of digital voice activity.

### ❖ Scanner Evolution

At the heart of every scanner is a receiver, capable of quickly tuning to a specific frequency and checking whether a transmission is in progress. If so, the received signal is filtered and routed to an audio amplifier, where it is made available to the user via the speaker or a headphone jack. In the AR8000 and other conventional scanners of the time, that's about all the "signal processing" that is done.

As technology developed and trunked radio systems came on the scene, scanner manufacturers added a decoder feature that can take the received signal and extract any digital information it might contain. The decoder, when programmed correctly, is able to understand the instructions sent on a control channel and can tune the receiver to the proper voice frequency. Audio is then sent to the speaker or headphone jack while the decoder puts relevant information on the display. This advancement allows scanners to automatically track conversations occurring on trunked radio systems.

As digital systems like APCO Project 25 (P25) became more common, scanner manufacturers added another step in the signal processing chain. Because P25 voice traffic is digital, the scanner could not route the received voice signal directly to the user – all they would hear would be a loud buzzing noise (which is exactly



### Conventional Scanner

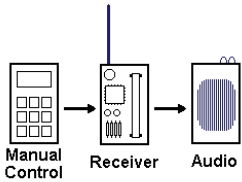

### Trunking Scanner

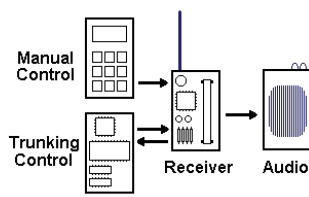

### APCO-25 Digital Trunking Scanner

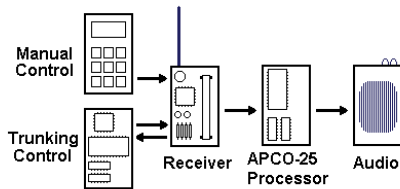

what happens when an analog scanner like the AR8000 is tuned to a digital transmission). Instead, the signal is routed to a digital voice decoder where it is converted into an analog sound that a human ear can understand.

### Multi-Scanner Tracking

Even though the AR8000 can't follow trunked systems or decode digital audio, it is as good as it ever was for monitoring non-trunked analog systems that are still quite common in suburban and rural areas. Even in cities you can find a great deal of analog activity, regardless of whether the major police and fire departments have moved to trunked or digital networks.

For the more computer-literate, the AR8000 can also serve a useful role as part of a larger monitoring station. In such an arrangement, two scanners work with a computer to track activity on an analog trunked radio system. The first scanner is tuned to the control channel frequency of the system and feeds the received control data into the computer, either through a sound card or a digital data "slicer." The computer decodes the data and identifies the voice frequencies carrying talkgroup activity.

When a talkgroup of interest becomes active, the computer commands the second scanner to tune to that voice frequency, allowing the station operator to hear the conversation.

A computer-controlled monitoring station like this has a few advantages over a modern scanner. First, because the computer is decoding and processing every message appearing on the control channel, it provides an in-depth view of activity on the radio system that might

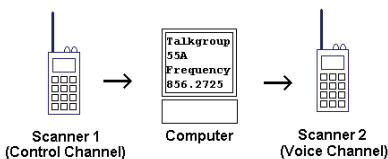

### Computer-Aided Multi-Scanner Monitoring

otherwise be hidden or skipped.

Private talkgroups identifying unknown, sensitive, or rarely seen users can be found. Lists of individual radio identifiers can be cataloged, along with their geographic loca-

tion, as they register with local repeater sites. Little-used system features like radio lockout for suspected stolen radios or remote microphone activation can be observed.

Even for the more casual listener it allows talkgroup prioritization, giving the operator the ability to interrupt an ongoing conversation to switch to a more interesting one. The monitoring station can do this because it has two receivers, one of which is constantly monitoring the control channel. A scanner can only tune to one frequency at a time; it is tuned to a voice channel when listening to a conversation and will miss any messages that might appear on the control channel during that time.

### Central Virginia

Since 1996, Amherst County, Bedford County, the City of Bedford and the City of Lynchburg in Virginia have been operating a regional emergency communication system called the Central Virginia Radio Communications Board (CVRCB). The CVRCB has determined that the radio equipment purchased fifteen years ago has finally reached the end of its useful life and needs to be replaced.

Early this year the four localities decided to dissolve the CVRCB and replace it with a new Region 2000 Radio Communications Board and make it a committee of Virginia's Region 2000 Local Government Council. The new board will fund, manage and operate the new radio equipment.

Region 2000 is home to nearly 200,000 residents across 2,000 square miles, served by more than 3,000 first responders and other municipal workers.

This summer the Radio Communications Board awarded Harris Corporation a contract worth \$11.8 million to design and install a new system using APCO Project 25 standards. The stated goal, as with almost all of these kinds of arrangements, is improved interoperable communications between agencies and departments within the region.

Harris has about 800 employees in the local area. They acquired the Lynchburg facility when they bought the Wireless Systems Segment from Tyco Electronics in 2009.

The new system will have 14 repeater sites and will replace the three existing interconnected systems and the 15-year-old shared infrastructure. The plan calls for testing in 2013 and full operation by early 2014.

Some of the 11 existing repeater sites may be relocated to provide better coverage. Three new towers are planned -- two in Bedford County and one in Amherst County.

Funding remains an issue. The \$11.8 million does not include mobile radios, so each jurisdiction will need to expend additional

monies. Operational costs will be split in proportion to the amount of equipment each entity needs -- Bedford County: 37%, Lynchburg: 30%, Amherst County: 28% and Bedford City: 5%.

Adjacent counties of Campbell and Appomattox were asked to join the new system but both declined.

### Lawrence County, Indiana

*Can I decode the Lawrence County Sheriff tactical channel from Bedford, Indiana?*

*Andy in Indiana*

Lawrence County is an area of about 450 square miles located in southern Indiana, between Indianapolis and Louisville, Kentucky. Just over 46,000 people live in the county, with nearly a third of them residing in the county seat of Bedford. Curiously, more than a quarter of Bedford's population is over 60 years old, and 17 percent is over 70, which is far higher than the state average.

Much of the public safety radio traffic in Lawrence County is on conventional (non-trunked) frequencies in analog format, including the Sheriff's Department, so there is no need to decode their transmissions. Any scanner capable of tuning to the VHF frequencies listed below should work fine to monitor activity.

### Frequency Description

- 151.0100 County Highway Department
- 151.1600 Bedford Parks Department

## WWW.SCANCAT.COM

**TOLL FREE 888-722-6228**

**ScanCat-Lite-PLUS**

*Reg. \$39.95 - Limited Time Special \$29.95*

**Now It's Easier Than Ever To Program Your Scanner.**

**FREE walk-you-through set up videos.**

[www.scancat.com](http://www.scancat.com)

**ScanCat-Lite-PLUS**

- Supports over 50 scanners in our one single program
- Import One Scanner's frequencies, Program any other radio scanner with the same frequencies

**COMBO ALL-IN-ONE CD**

ScanCat-Lite-Plus.....\$29.95  
Mr. Scanner FCC Public Safety .....29.95  
Nat-Com's FCC Scancat Files .....9.95  
Bonus Disk Of Frequencies.....15.00  
If Purchased Separately \$84.85

**NOW \$49.95**

Plus \$6 s&h

**PLUS FREE** Scanning Magazine(s)  
(With Any Order Over \$40.00)

**NOW AVAILABLE \$CALL HOKA Code 3-32**

**COMPUTER AIDED TECHNOLOGIES**

ORDERS: (318) 687-4444 FAX: (318) 686-0449  
Info/Tech Support: (318) 686-1999  
(9 a.m. - 3 p.m. Central M-F)

## WWW.SCANCAT.COM



- 151.2950 County Emergency Management Agency
- 151.3775 County EMS (Dispatch)
- 154.0550 Bedford Fire
- 154.2350 County Fire (Dispatch)
- 154.2650 National Fire Mutual Aid
- 154.2800 National Fire Mutual Aid
- 154.2950 National Fire Mutual Aid
- 154.3100 Bedford Fire and Emergency Medical Services (Dispatch)
- 154.8000 Bedford Police (Encrypted)
- 154.9500 Sheriff (Operations)
- 155.0250 County Search and Rescue
- 155.0700 Bedford Regional Medical Center
- 155.1300 Indiana Law Enforcement (Statewide)
- 155.1600 National Search and Rescue
- 155.2350 Dunn Memorial Hospital Emergency Medical Services
- 155.2800 Indiana Hospital Emergency Radio Network (IHERN)
- 155.3400 Indiana Hospital Emergency Radio Network (IHERN)
- 155.3700 Indiana Law Enforcement (Statewide)
- 155.4750 Indiana Law Enforcement Emergency Network (ILEEN)
- 155.5650 Bedford Police (Encrypted)
- 155.6850 Sheriff (Dispatch)
- 156.1050 Bedford Street Department
- 158.7750 Bedford Police (Encrypted)
- 158.8500 County Jail
- 159.2250 Department of Natural Resources
- 159.2400 Department of Natural Resources
- 159.3450 Department of Natural Resources
- 159.4050 Department of Natural Resources
- 159.4350 Department of Natural Resources
- 161.5500 Sheriff (Tactical)

The unusual exception to the listed frequencies is the Bedford Police Department. According to local reports, the Department encrypts all of their transmissions.

In 2007, Bedford Police began preparations to switch to operation in the 800 MHz band and finally made the transition in early 2009, joining the statewide Project Hoosier SAFE-T network. They experienced a number of problems after the transition, including a complete radio system failure when the community tornado warning sirens were activated in April 2009.



Bedford Police also made the decision to encrypt all of their transmissions, preventing helpful citizens from reporting timely information that could help law enforcement. For a town of less than 14,000 people, such a decision seems unnecessary and shortsighted. It's also counter-productive, since one of the primary purposes of the SAFE-T network was to allow seamless interoperability with other agencies. Encryption makes such cooperation much more difficult.

In 2010 the Bedford Police Department used Federal grant money to purchase ten Kenwood Nexedge 800 radios, which was sufficient to equip half the department fleet.

Although the Bedford Police Department is listed as a participating local agency on the SAFE-T network, the Federal Communications Commission (FCC) license database currently shows 154.800, 155.565, and 159.030 MHz as actively licensed to the Bedford Police Department. These frequencies are used by repeater sites located on the water tank at the corner of 5th and K Streets and at City Hall.

The Project Hoosier SAFE-T system is a Motorola Type II SmartZone network that first went live ten years ago. It serves nearly 50,000 users from hundreds of state and local public safety agencies. The system carries voice activity in both analog and digital formats and can be monitored by any digital-capable scanner, since digital transmissions use the APCO Project 25 standard Common Air Interface (CAI).

There are two SAFE-T repeater sites in Lawrence County, identified in the system as numbers 35 and 522. The first is located in the town of Georgia and transmits on the following frequencies: 851.4875, 852.4875, 852.9875 and 853.4875 MHz. The second site is in Bedford and uses 851.6750, 851.9125, 852.3875, 852.8125 and 853.9625 MHz.

Talkgroups on the system for Lawrence County include the following:

| Decimal | Hex | Description                                  |
|---------|-----|--|
| 21968   | 55D | County Emergency Management Agency 1         |
| 21984   | 55E | County Emergency Management Agency 2         |
| 21728   | 54E | County Fire (Dispatch)                       |
| 21744   | 54F | County Fireground 1                          |
| 21760   | 550 | County Fireground 2                          |
| 21776   | 551 | County Fireground 3                          |
| 21792   | 552 | County Fireground 4                          |
| 21872   | 557 | Bedford Regional Medical Center (Dispatch)   |
| 21888   | 558 | Bedford Regional Medical Center Operations 1 |
| 21904   | 559 | Bedford Regional Medical Center Operations 2 |
| 21920   | 55A | Dunn Memorial Hospital (Dispatch)            |
| 21936   | 55B | Dunn Memorial Hospital Operations 1          |
| 21952   | 55C | Dunn Memorial Hospital Operations 2          |
| 21648   | 549 | County Sheriff (Dispatch)                    |
| 21664   | 54A | County Sheriff Operations 1                  |
| 21680   | 54B | County Sheriff Operations 2                  |
| 21808   | 553 | Bedford Fire (Dispatch)                      |
| 21824   | 554 | Bedford Fireground 1                         |
| 21600   | 546 | Bedford Police (Encrypted)                   |
| 21616   | 547 | Bedford Police Operations 1                  |
| 21632   | 548 | Bedford Police Operations 2                  |

## ❖ Allen County, Indiana

In the northeastern part of Indiana, Allen County and the City of Fort Wayne agreed in May to spend about \$17 million on new Motorola equipment and radios. Under the spending plan, the county would purchase \$2.9 million worth of radios while the city would spend \$5.6 million for their units. The \$8.5 million cost of infrastructure, including new software and repeater site equipment, would be split between the two entities.

The current system is Motorola Type II network, meaning the control channel follows the traditional Motorola 3600-baud format. All trunk-tracking scanners understand this format and can follow conversations on the system. However, those conversations may use either analog format or digital P25, so only digital-capable trunk-tracking scanners can hear every conversation (unless they're encrypted as well).

System frequencies are 851.3250, 851.3500, 851.5625, 851.5875, 851.7375, 851.8250, 851.8625, 852.0750, 852.1125, 852.1375, 852.3375, 852.7125, 852.7625, 852.8375,

853.1500, 853.2750, 853.3000, 853.7625 and 853.8375 MHz.

Talkgroups on the system include:

| Decimal | Hex | Description                                      |
|---------|-----|--|
| 1744    | 06D | Sheriff (Corrections 1)                          |
| 1776    | 06F | Sheriff (Corrections 2)                          |
| 1872    | 075 | Sheriff (Corrections 3)                          |
| 8016    | 1F5 | Fort Wayne Fire Alerts                           |
| 24688   | 607 | Sheriff Tactical 2                               |
| 24720   | 609 | Sheriff Tactical 3                               |
| 24752   | 60B | Sheriff Tactical 4                               |
| 24784   | 60D | Sheriff Tactical 5                               |
| 24816   | 60F | Sheriff Tactical 6                               |
| 24848   | 611 | Sheriff Tactical 7                               |
| 24880   | 613 | Sheriff Tactical 8                               |
| 25616   | 641 | Sheriff (Dispatch)                               |
| 25648   | 643 | Sheriff (Records)                                |
| 25680   | 645 | Sheriff (Car-to-Car)                             |
| 25712   | 647 | Sheriff (Common)                                 |
| 25744   | 649 | Sheriff (Traffic)                                |
| 25776   | 64B | Sheriff (Detectives)                             |
| 25808   | 64D | Sheriff (Warrants)                               |
| 25840   | 64F | Sheriff (Vice) (Encrypted)                       |
| 26032   | 65B | Sheriff (Home Detention)                         |
| 25936   | 655 | County Animal Control                            |
| 25968   | 657 | Sheriff (Special Weapons and Tactics)            |
| 27216   | 6A5 | Fort Wayne Police (Dispatch Northwest)           |
| 27248   | 6A7 | Fort Wayne Police (Car-to-Car Northeast)         |
| 27280   | 6A9 | Fort Wayne Police (Dispatch Southwest)           |
| 27312   | 6AB | Fort Wayne Police (Car-to-Car Southeast)         |
| 27344   | 6AD | Fort Wayne Police (Information North)            |
| 27376   | 6AF | Fort Wayne Police Investigations 1               |
| 27408   | 6B1 | Fort Wayne Police Investigations 2 (Encrypted)   |
| 27472   | 6B5 | Fort Wayne Emergency Services Team 1 (Encrypted) |
| 27504   | 6B7 | Fort Wayne Emergency Services Team 2             |
| 27568   | 6BB | Fort Wayne Police (Records)                      |
| 27632   | 6BF | Fort Wayne Police (Car-to-Car 1)                 |
| 27664   | 6C1 | Fort Wayne Police (Car-to-Car 2)                 |
| 27856   | 6CD | Fort Wayne Police (Canines)                      |
| 28048   | 6D9 | Fort Wayne Parking Enforcement                   |
| 28208   | 6E3 | Fort Wayne Police (Gang Unit)                    |
| 28240   | 6E5 | Fort Wayne Police (Information South)            |
| 30416   | 76D | Fort Wayne Fire (Dispatch)                       |
| 30448   | 76F | Fort Wayne Fireground 1                          |
| 30480   | 771 | Fort Wayne Fireground 2                          |
| 30512   | 773 | Fort Wayne Fireground 3                          |
| 30544   | 775 | Fort Wayne Fire Prevention                       |
| 30576   | 777 | Fort Wayne Fire Training                         |
| 30608   | 779 | Fort Wayne Arson Investigation                   |
| 30640   | 77B | Fort Wayne Fire Command 1                        |
| 30672   | 77D | Fort Wayne Fire Command 2 (Encrypted)            |
| 30704   | 77F | Fort Wayne Fireground 4                          |
| 30736   | 781 | Fort Wayne Fireground 5                          |
| 30768   | 783 | Fort Wayne Fireground 6                          |
| 30800   | 785 | Fort Wayne Fire Academy                          |
| 32016   | 7D1 | County Fire (Dispatch)                           |
| 32176   | 7DB | County Fireground 1                              |
| 32208   | 7DD | County Fireground 2                              |
| 32240   | 7DF | County Fireground 3                              |
| 32464   | 7ED | County Fire (Northeast)                          |
| 33744   | 83D | Airport Operations                               |
| 35520   | 8AC | County Fire (Southwest)                          |

That's all for this month. You can get more scanner and radio-related information on my website at [www.signalharbor.com](http://www.signalharbor.com) and I welcome your electronic mail to [danveeneman@monitoringtimes.com](mailto:danveeneman@monitoringtimes.com). Until next month, happy scanning!





## ❖ Correction to AC plug wiring answer

In my July column I mistakenly identified the narrow flat blade of an AC plug as neutral; it's actually the wide blade. The narrow blade is hot. In three-wire AC systems, the green wire is ground, the white wire is neutral, and the black wire is hot. Thanks for sharp eyed readers for catching me on this one!

## ❖ And an oversight

In my short list of services that won't have to narrowband by 2013, I shouldn't have listed railroads. They, too, as FCC Part 90 licensees, are required to go narrowband, and have already started converting. Thanks to sharp-eyed reader J.J. Owens for spotting the error.

**Q.** *If I were to make a square of four 450-ft wires for a receiving antenna, would I get signals from all four directions equally? And does it matter where I "tap" the antenna? (George Santulli, Lovettsville, VA)*

**A.** If you make a square antenna like you propose, you've created a horizontal loop, and it's essentially non-directional in its uniform response from all directions.

Staying with 450 feet on a side, you would have an excellent, horizontal-loop, omnidirectional receiving antenna for the AM broadcast band as well as shortwave. The actual formula for this is to divide 1005 by the lowest critical frequency in megahertz to get the total perimeter in feet. This provides a balanced feedpoint impedance of about 450 ohms for 1.8 MHz and higher.

But you are more concerned with the uniform pattern from all directions rather than impedance matching for transmitting. If you want to provide closer impedance matching, you could use a common 4:1 balun transformer (or wind your own 6:1) and run low-loss coax like RG-6/U to it.

You can break the loop to feed it at any point, although it is most commonly fed at one of the corners since that's a physical support point.

Height should be at least 40 feet for best response; the higher, the better. Lower elevation increases ground reflectivity – great for receiving overhead aircraft, but poor for long distance reception!

**Q.** *Can Earth's shortwave broadcasts be heard from outer space, and have astronauts in orbit ever*

*monitored these broadcasts? (Joe Wood, Greenback, TN).*

**A.** Yes, signals in the HF spectrum can penetrate the ionosphere and radiate into space depending on solar influences which change throughout the day and night. The higher the frequency, the more likely they escape. We can listen to Jupiter's electrical storms on 20 MHz, and 15.016 MHz SSB was a backup frequency for the Gemini space program. It is unlikely, however, that the astronauts made any attempts to listen to international broadcasters during their busy missions, nor that they had tunable radios with which to do it.

**Q.** *I would like to use two shortwave receivers at the same time on the same antenna; will a standard TV splitter allow this without losing signal strength? (Bill Von Wida, email)*

**A.** Absolutely. You will lose about 3 dB since you are splitting the signal in half, but you won't notice it in listening.

**Q.** *I've installed an outdoor wire antenna, but I'm concerned about grounding. Just what do I need to do and where to I connect it? (Dave Scheffler, email)*

**A.** In the radio lexicon, there are several meanings for "grounding." One refers to a common connection for all components that need to be eventually tied together, and that's usually the radio chassis and includes the negative power connection.

Another refers to actual earth ground. This is for two reasons: To provide a complete radio-frequency antenna system using the earth as part of the system, and to make sure there are no AC hum components to interfere with reception.

When your radio room is high above the earth, it's hard to get any antenna system improvement because of the wavelength issue – the common signals should be in phase to be zero in voltage difference. But neutralizing the hum voltage and other electrical interference from power lines and nearby accessories is still a possibility.

A good earth ground consists of at least one 8-ft metal pipe in moist earth; better, two pipes separated by several feet). The ground wire going down from your radio's chassis or coax connector (shielding) should be large, like coax braid or heavy-duty braided wire.

Even so, noise reduction isn't guaranteed; it's a hit and miss proposition, but you are always better off with the ground than without it, even if only for shock protection.

**Q.** *As a youth I remember that a drug store had a tube tester with many different sockets in which to insert a vacuum tube. Can you enlighten me on what these were? (Mark Burns, Terre Haute, IN)*

**A.** Indeed I can; I even owned one! These were very simple and strictly tested cathode emission to the plate of the tube (electrons migrating from the filament-heated cathode to the positive plate). They could also test for shorts, but they were not what is known as dynamic tube testers (transconductance or mutual conductance) that actually did in-circuit emulation using the grid(s) as well as the cathode and plate.

Rather than requiring the customer to complicate the procedure by turning switches to different positions for a given socket as different types of tubes were inserted, the manufacturer provided enough prewired sockets to anticipate the pin-out of just about every tube on the market.

**Q.** *I have heard that NASA keeps an eye on every piece of "space junk" that orbits the earth. Is this true and, if so, how do they do it? (Mark Burns, Terre Haute, IN)*

**A.** Orbital space debris, which includes everything from particles and paint chips up to satellites, numbers in the tens of millions. Keeping track of all this is not NASA, nor is it NORAD. That job falls to the Joint Space Operations Center of the U.S. Strategic Command at Vandenberg Air Force Base, through the Space Surveillance Network (SSN), a global network of 29 space surveillance sensors that include military and civilian radar and optical telescopes used to observe these objects. SSN makes up to 420,000 observations each day.

So far as how many pieces are currently being tracked – those pieces as small as a couple of inches and as large as three feet – the most recent quote I've seen is 22,000 individual.

Other, more sensitive radars are being developed, but particles smaller than those now tracked are considered relatively harmless against the rubber bumpers on the International Space Station (ISS). Even so, these tiny particles travel at a velocity of up to 17,500 miles per hour – more than 20 times the speed of sound! Depending on size, the impacts can be consequential.

Questions or tips sent to Ask Bob, c/o MT are printed in this column as space permits. Mail your questions along with a self-addressed stamped envelope in care of MT, or e-mail to [bobgrove@monitoringtimes.com](mailto:bobgrove@monitoringtimes.com). (Please include your name and address.)





# Dutch Spy Bust Fuels New “Numbers” Intrigue

**T**he timing of changes in Russian “numbers” broadcasts continues to reinforce the common theory as to what they are about: Indeed, they are for spies.

When we left off this particular story, members of ENIGMA 2000, the online incarnation of the European Numbers Information Gathering and Monitoring Association, were tracking a specific schedule. It was designated “XPA b” on their list of these mysterious broadcasts.

XPA b is thought to come from the SVR, a Russian foreign intelligence service. It had gone to null messages (one group of zeroes) on October 20, 2011.

This change came only two days after the rather dramatic arrest of a German couple. As the story goes, police broke down their door while they were receiving this station and decoding it on their computer. Investigation linked them to the same United States sleeper cell whose exposure made Anna Chapman into a media phenomenon.

As we know, the attractive Chapman and nine others were subsequently sent back to Russia in a diplomatic exchange. She is still promoting her Mata Hari image there, with jobs in modeling and television, not to mention an action figure on [www.HeroBuilders.com](http://www.HeroBuilders.com).

Last year, Paul Beaumont of ENIGMA contacted this column offering an explanation which connected the German arrests with the XPA b changes. He also predicted that, if the responsible Russian intelligence agency ran true to form, it would continue with the null messages for some months, and then vanish. Sure enough, on June 7, 2012, it did just that. Nothing has been heard since.

That’s mildly interesting, for hard core utility fans, but it gets much better.

### ❖ Raymond P

We pick up our story on March 31, 2012. This is the date of a story in *Telegraaf*, a Dutch newspaper, which describes one “Raymond P,” a well-traveled employee of the Dutch foreign ministry. He had been picked up on suspicion of laundering money. He had a Glock handgun and a large sum of cash in his possession.

Subsequent news accounts in April describe the assertion of a prosecutor in The Hague that “Raymond P” was one Raymond Poeteray. He was subsequently accused of passing hundreds of classified documents to that same German couple arrested last October.

Poeteray had the usual sensitive material on his computer. Russian intelligence had alleg-

edly just paid him 90,000 Euros for his services. Various other accusations indicate that Mr. P was probably not a very nice man at all. And yes, the prosecutors linked him to the Chapman cell.

Paul Beaumont has once again contacted this column, with the very credible theory that another XPA b behavior was linked to all this. It seems that, in the long string of null messages, two that did have content stand out. They were sent on October 25th and 27th of last year, presumably to give Poeteray his instructions.

After Mr. P’s arrest, another Russian number schedule vanished from the air. This one is designated E06, one of Russian intelligence’s gaggle of English broadcasts using the same machine-generated format as those in several other languages.

E06, also known as The English Man, sent the last broadcasts of this particular weekend schedule on June 16. The frequencies, which changed monthly, had been 7608 and 8142 kilohertz (kHz), at 0030 Saturday and 0130 Sunday, with a repeat an hour later on both days. (All times in this column are UTC - Coordinated Universal Time.) Signal strength was high in Western Europe, suggesting a beam in that direction.

Beaumont notes that E06 slots have vanished before. The last time it happened was after the former head of Estonia’s National Security Authority had been picked up as a Russian spy. Soon after, the E06 schedule on Sunday at 1830 and 1930 UTC had vanished.

This episode of our continuing narrative ends with the publication of a news item dated June 27, 2012 in *The Moscow Times*. It reports Mr. P’s arrest as if it had just happened, complete with a large photo of the attractive Ms. Chapman. It is not known why this publication took three months to run the story. Perhaps the news had been embargoed until their country’s intelligence control suggested by these numbers station changes.

As always, this column thanks Paul and ENIGMA 2000 for their valuable assistance in sorting all this out.

### ❖ Are “Numbers” Obsolete?

Comments on a web site reporting this story have once again raised the question of whether the numbers broadcasts, or radio in general, are needed any more. After all, we are now in an age when everyone in industrial countries car-

|       |       |       |       |       |       |
|-------|-------|-------|-------|-------|-------|
| 95457 | 53497 | 23894 | 37708 | 51392 | 44887 |
| 59659 | 73920 | 51392 | 05263 | 21432 |       |
| 06439 | 25297 | 51392 | 1296  | 51350 |       |
| 61468 | 07811 | 51392 | 472   | 05529 |       |
| 37993 | 51392 | 51392 | 54    | 65932 |       |
| 29553 | 18439 | 51392 | 16    | 45143 |       |
| 95457 | 51392 | 51392 | 12    | 44887 |       |
| 59659 | 73920 | 51392 | 63    | 21432 |       |
| 06439 | 25297 | 51392 | 296   | 51350 |       |
| 61468 | 07811 | 51392 | 8472  | 05529 |       |
| 37993 | 51333 | 51392 | 61554 | 65932 |       |
| 29553 | 18439 | 13630 | 05569 | 51286 | 45143 |



ries global information sharing capacity around with them.

In fact, spies already use computers, and they always will. However, don’t rule out the traditional “one-time pad” system used by the numbers broadcasts. It is still the most secure system known, as long as everyone follows the proper procedures.

An interesting paper by Dirk Rijmenants, called *Cuban Agent Communications: Failure of a Perfect System* addresses this issue. It cites several provocative Cuban spy arrests in the United States, and how these were facilitated by various lapses in their communications system.

Most of these failures were caused by attempts to render the traditional system less tedious by putting various procedures onto computers. Perhaps the digital modulation coming from Cuba’s “SK01” station was part of all this.

Obviously, these mistakes were fortunate for the national security of the United States. However, they were very unfortunate for those who, to quote the paper’s conclusions, showed “how you can turn a perfectly secure pencil-and-paper encryption scheme into an insecure computer application.”

And this is not even addressing the issues raised by the tendency of computers to leave data in all manner of inconvenient places, making the receivers of messages easier to identify. In the case of radio, the transmitters are easy to locate, but finding the receivers is vastly harder.

It will be interesting to see if other agencies try to fix things that were never really broken.

### ❖ USCG Discontinues Telex

For years, the United States Coast Guard communications station NRV, in Guam, had been the service’s last holdout for traditional, on-demand, ship telex using Simplex Teleprinting Over Radio, mode A (SITOR-A). This mode



is easily recognizable on-air from its screechy burst markers with a Morse code station identification, and its chirp-chirp sound when passing traffic.



Most large vessels, including Coast Guard cutters, now use various satellite systems for this. And so, on March 31 at 2359 UTC, the service stopped. Ships can no longer use NRV's automated menus to send such traffic as AMVERs (positions for the Automated Mutual-Assistance Vessel Rescue System), or OBS (formatted weather observations from participating vessels). However, the remaining commercial stations will still take these for free.

Interestingly, as of July 2012, NRV is still sending markers with this call sign on their usual frequencies. Mario Filippi has confirmed 8422.0 kHz, and this editor hears 16812.5 and 22382.0 daily. This leaves only 12579.0 and 12585.0 as unconfirmed.

Despite recent ownership changes, ShipCom LLC still accepts SITOR-A traffic on its many frequencies at WLO (Mobile, AL), and KLB (Seattle, WA). Also, other Coast Guard services such as weather and radiofax are unaffected.

## ❖ CODAR Chaos May Diminish

CODAR stands for Coastal Ocean Dynamics Applications Radar. It was developed in the 1970s by the US National Oceanic and Atmospheric Administration (NOAA) for the accurate real time mapping of sea waves

and surface currents.

Since then, several other uses have been found for this technology. A private company, also known as CODAR, offers a whole line of SeaSondes and RiverSondes. Agencies have also shown some interest in its use for coastal surveillance.

For reasons relating to the physics involved, these radars operate in the high frequency (HF) band, around 5, 12, and 25 megahertz (MHz). They produce a distinctive pweeng, pweeng, pweeng sound, often sweeping out 25 to 50 kHz. While the power used is quite low, signals can still be loud. Those who have tried hunting weak utilities at night around 4.5 MHz may be all too aware of this situation.

While HF sea surface radar is here to stay, order may finally be coming to its licensing and spectrum management. The International Telecommunications Union (ITU) has published its new frequencies and regulations for these radars.

Here are the new bands (in kHz): 4438-4488, 5250-5275, 9305-9355, 13450-13550, 16100-16200, 24450-24650, 26200-26420, and three bands above 30 MHz. The exact status of these allocations will vary between ITU regions and even some specific countries, the way it always does.

It is extremely likely that the 50-kHz bands below 10 MHz will be divided into two 25-kHz ranges, allowing more radars to co-exist while also restricting their sweep ranges. The higher 100-kHz bands will probably be split into 50-kHz channels.

Finally, it will become possible to DX these radars. They will be required to identify in the International Morse Code every 20 minutes.

As with all ITU decisions, nothing will happen overnight. Expect a period of months to years for the transition. After that, expect less chaos.

## ABBREVIATIONS USED IN THIS COLUMN

|               |   |              |  |
|---------------|---|--------------|--|
| AFB.....      | Air Force Base                                    | NASA.....    | US National Aeronautics and Space Administration   |
| ALE.....      | Automatic Link Establishment                      | NATO.....    | North Atlantic Treaty Organization                 |
| AWACS.....    | Airborne Warning and Control System               | NCS.....     | US National Communications System                  |
| CAMSLANT..... | Communications Area Master Station, Atlantic      | PACTOR.....  | Packet Teleprinting Over Radio, modes I-IV         |
| COTHEN.....   | US Customs Over-The-Horizon Enforcement Network   | PSK.....     | Phase-Shift Keying                                 |
| CW.....       | On-off keyed "Continuous Wave" Morse telegraphy   | RTTY.....    | Radio Teletype                                     |
| DHFCS.....    | UK Defence High-Frequency Communications System   | Selcal.....  | Selective Calling                                  |
| DSC.....      | Digital Selective Calling                         | SHARES.....  | SHARed RESources, US Federal interagency freq pool |
| EAM.....      | Emergency Action Message                          | SITOR.....   | Simplex Telex Over Radio, modes A & B              |
| FAX.....      | Radiofacsimile                                    | UK.....      | United Kingdom                                     |
| FEMA.....     | US Federal Emergency Management Agency            | Unid.....    | Unidentified                                       |
| FSK.....      | Frequency-Shift Keying                            | US.....      | United States                                      |
| HFDL.....     | High-Frequency Data Link                          | USAF.....    | US Air Force                                       |
| HFGCS.....    | High-Frequency Global Communications System       | USCG.....    | US Coast Guard                                     |
| LDOC.....     | Long-Distance Operational Control                 | V13.....     | Taiwan "New Star," music and numbers in Chinese    |
| M12.....      | Russian CW "numbers"                              | VC01.....    | Robotic "Voice Chip" Chinese numbers               |
| M89.....      | Chinese military CW coded call signs              | Volmet.....  | Scheduled, formatted, aviation weather broadcasts  |
| MARS.....     | US Military Auxiliary Radio System                | XPA.....     | Russian Intelligence, tone-coded numbers messages  |
| MX.....       | Generic for Russian single-letter beacons/markers | WMD-CST..... | US Weapons of Mass Destruction Civil Support Team  |

All transmissions are USB (upper sideband) unless otherwise indicated. All frequencies are in kHz (kilohertz) and all times are UTC (Coordinated Universal Time). "Numbers" stations have their ENIGMA (European Numbers Information Gathering and Monitoring Association) designators in ( ).

|        |   |        |   |
|--------|---|--------|---|
| 3176.0 | LOR-Argentine Navy, Puerto Belgrano, RTTY weather in Spanish, at 0038 (Mario Filippi-NJ).   | 6846.0 | VMSZ-Russian military, passing CW message in Russian Morse to collective call JFQ2, then getting rogers from BWSA, 9P1X, and U71, at 2050 (MPJ-UK).   |
| 4149.0 | WPE Jacksonville-Crowley Marine, FL, getting status of tugboat Navigator, at 0457. Similar check-ins with Crowley tugs WBN 6511 at 0459, Seahorse at 0501, Ranger at 0505, WBN 4382 at 0509, and Sea Breeze at 0511 (Allan Stern-FL). | 6853.0 | FAV-French Morse code training (M51), Favières, CW drill message in 5-letter groups at 2048 (MPJ-UK).   |
| 4553.5 | ZLST-German Customs Control Center, Cuxhaven, calling ZKNI, patrol boat Kniepsand, ALE at 0751 (Michel Lacroix-France).   | 6949.0 | M51, different CW drill message from one on 6853, at 2035 (MPJ-UK).   |
| 4594.0 | 4XZ-Israeli Navy, CW message in 5-letter groups, parallel on 6608, similar on 6830, at 0212 (Filippi-NJ).   | 6985.0 | BULLTOC-US military Tactical Operations Center, calling PALADIN6, BULL1, BULL2, and BULL3; ALE at 1521 (Jack Metcalfe-KY).  |
| 4945.0 | EPA-Unknown Canadian station, sending random multi-frequency dialing tones and periodically identifying, "This is EPA, Vancouver, testing," at 0409 (Hugh Stegman-CA).  | 7527.0 | 708-USCG HC-130H #1708, ALE sounding on COTHEN, at 0613 (MDMonitor-MD).   |
| 5505.0 | Shannon Volmet, Ireland, aviation weather for several European airports, at 0023 (Filippi-NJ).  | 7739.0 | Unid-Chinese Robot (VC01), fast machine voice at 0811 and 1023 (Boender-Hong Kong).   |
| 6577.0 | American 94-Flight making a selcal check with an unknown ground station on the Caribbean air control net, at 0010 (Filippi-NJ).   | 8414.5 | 9V8312-Singapore flag tanker <i>Maersk Hakone</i> , DSC safety test with Vung Tau, Vietnam, at 1828. C6LO4-Bahamas flag Multipurpose Offshore Vessel <i>Dynamic Installer</i> , DSC safety test with Cape Town, South Africa, at 1843 (MPJ-UK). |
| 6640.0 | New York LDOC, patching Air Transat 610 to company for a long maintenance discussion, mostly in an unknown language [French? -Hugh] with some English error messages, at 0535 (Stern-FL).   | 8422.0 | NRV-USCG, Guam, CW identifier in SITOR-A sync marker, at 1205 (Filippi-NJ). [USCG dropped its last telex services in March, but these freqs stayed up. -Hugh]   |
| 6699.9 | Veilleur-French Air Force command center, Taverny, working Cyrano, Avord AWACS, at 1251 (Lacroix-France).   | 8425.0 | XSG-Shanghai Radio, China, CW identifier in SITOR-A sync bursts, at 1948 (MPJ-UK).  |
| 6738.0 | Top Rider-US military Skymaster exercise, many EAMs, some very long, simulcast on at least 8992, 11175, and 15015 HFGCS; then "standing by for traffic," at 0030 (Hugh Stegman-CA).   | 8438.3 | KSM-Maritime Radio Historical Society, Pt. Reyes National Seashore, CA, usual CW marker stopping abruptly for hand sent version with distinctive semiautomatic "bug" sound, simulkeying 12993.0, at 1940 (Stegman-CA).                          |
| 6826.0 | FAV-French military Morse code training, CW drill messages at 0844 (Lacroix-France).  | 8473.0 | WLO-ShipCom, AL, RTTY international news at 1108 (Filippi-NJ).  |
| 6840.0 | NYZ-Auto-generated call of Chinese military CW marker (M89), calling Q2M, parallel 10640, at 1020 (Ary Boender-Hong Kong Remote).   | 8502.0 | NMN-USCG CAMSLANT Chesapeake, VA, "Iron Mike" voice-synthesized weather, at 1007 (Filippi-NJ).  |
|        |   | 8886.0 | G-VOGE-Virgin Atlantic A340 "Cover Girl," flight VS0201, HFDL log-on with Krasnoyarsk, Russia, at 1948 (MPJ-UK).  |

- 8888.0 Syktyvkar Volmet, male voice in Russian with aviation weather, off at 1934 (MPJ-UK).
- 8912.0 LNT-USCG CAMSLANT, VA, raising 718 (USCG HC-130H #1718) in ALE, then in voice asking Coast Guard 1718 to call MH-60J helicopter Coast Guard 6036 on a search for a drifting barge, at 1149 (MDMonitor-MD).
- 8977.0 ZS-SNC-South African Airways A340, flight SA0265, HFDL log-on with Reykjavik, Iceland, at 2102 (MPJ-UK).
- 8992.0 Ali Baba-US military, likely airborne command post, with 3 EAMs and then "standing by for traffic," at 0010 (Jeff Haverlah-TX).
- 9014.0 Unid-Possible Spanish Air Force flight, getting weather from unknown ground station, at 0801 (Lacroix-France).
- 9025.0 OFF-USAF, Offutt AFB, NE, raised HIK (Hickam AFB, HI) in ALE, then voice radio checks at 1125 (MDMonitor-MD).
- 9106.0 WWLNNN-US Navy/Marine Corps MARS station NNNOWWL, NJ, ALE sounding at 0220. RGI-Saudi Arabian military, calling JDI; also on 9117, 9160, 9176, 9199, 10333, 10366, and 10384; ALE at 1906 (PPA-Netherlands).
- 9110.0 NMF-USCG, Boston, MA, FAX text of request for comments, at 0311 (PPA-Netherlands).
- 9124.5 HLN-Russian military, control of CW duplex net with NPHL and SO80, similar on 10310, at 0332 (PPA-Netherlands).
- 9134.0 4I24-Russian military tactical call sign, typical CW marker calling YR8A with traffic; similar on 9149, 10362, 10394, and 12593; at 0454 (PPA-Netherlands).
- 9145.0 RIW-Russian Navy headquarters, Moscow, working RGR35, CW at 0238 (PPA-Netherlands).
- 9157.0 HEC-Bern Radio, Switzerland, hexadecimal identifier "CC" in Globe Wireless data marker, also on 10341, at 0522 (PPA-Netherlands).
- 9165.0 HLL-Korean weather office, Seoul, noisy FAX weather chart at 1830 (PPA-Netherlands).
- 9176.0 Unid-Russian Intelligence (M12), CW callup 257 257 257 1, then message in 5-figure groups with no repeat, ended TTT TTT (cut zero), at 1900 (PPA-Netherlands).
- 9182.0 L02-Chinese military, calling A96, also on 13241, 13422, and 13438.5, ALE at 1833 (PPA-Netherlands).
- 9200.0 2011-Moroccan Internal Security control station, calling 2519, ALE at 2009 (MPJ-UK).
- 9276.0 New Star Radio Station (V13)-Program 3, musical intro and coded messages in live female voice, at 0700 and 0800 (Boender-Hong Kong).
- 10000.0 Italcable Radio-Italian amateur AM experimental time station, beep and announcement in Italian 7 seconds before each minute, at 0831 (Lacroix-France).
- 10075.0 VH-OQE-Qantas Airbus A380 "Lawrence Hargrave," flight QFA1, HFDL position for Al-Muharrqa, Bahrain, at 1907 (MPJ-UK).
- 10093.0 "09"-HFDL ground station, Barrow, AK, squitters and working Polar Air Cargo flight PO0214, at 0430 (Stegman-CA).
- 10242.0 N03-USCG HC-144A #2303, calling Z16 (probably USCG Sector Mobile, AL), on COTHEN at 1449 (MDMonitor-MD).
- 10300.0 CM3-Algerian military command, Bechar, calling COF, ALE at 1910 (PPA-Netherlands).
- 10313.0 Unid-French Intelligence Morse training, Favières, CW drill message in 5-letter groups, at 1810 (PPA-Netherlands).
- 10315.0 DHN66-NATO, Geilenkirchen, Germany, working Magic 52 (E-3 AWACS back end), regarding reception of RTTY traffic, at 1904 (PPA-Netherlands).
- 10321.0 NJT-21st WMD-CST, NJ, calling CA3, WMD-CST in CA, ALE at 2202 (Metcalfe-KY).
- 10329.0 DG2089-German pleasure boat *Paso Doble*, working Sailmail in Chiriqui, Panama in PACTOR-III, at 0516 (PPA-Netherlands).
- 10343.0 Unid-M12, CW callup 124 124 124 1, then message header 5504 65, and message in 5-figure groups ending 000 000, at 1801 (PPA-Netherlands).
- 10344.5 XJD-UK DHFCS mobile, calling XSS, control in Forest Moor, UK; also on 11208, 11217, 11223, and 11241; ALE at 1728 (PPA-Netherlands).
- 10360.0 SAB-Goteborg Radio, Sweden, hexadecimal identifier DE in Globe data marker, at 1617 (PPA-Netherlands).
- 10379.4 A96-Chinese military, raised L03 in ALE, then data modem traffic, at 1754 (PPA-Netherlands).
- 10390.0 1303-Moroccan Police, ALE sounding, many other calls also copied, at 0421 (PPA-Netherlands).
- 10585.0 NJT-21st WMD-CST, NJ, ALE and ALE text with FC8FEM001006, unknown FEMA Region 8 entity using 3rd-generation long address, also on 12212, at 2113 (Metcalfe-KY).
- 10588.0 FR5FEM-FEMA Region 5, MI, testing their new ALE chat with text message, "FR5FEM SAYS: ^ WGY912 :THIS IS WGY 905 CHAT CHECK ?" at 1449 (MDMonitor-MD). [WGY 912 is FEMA Emergency Center, deep inside Mt. Weather in VA. -Hugh] WGY 907-FEMA Region 7, MO, voice patch to WGY 908, Region 8, CO, at 1605 (Metcalfe-KY).
- 11111.0 STAT21-Tunisia National Guard, working TUD, ALE at 0817 (Lacroix-France).
- 11175.0 Top Rider-US military, gave 3 EAMs (prefixes PAUUA3, PA536C, and PA6IA6), then by for traffic at 0127. Jane (sounds like)-same three EAMs and by for traffic at 0136. Ali Baba, same 3 EAMs and by for traffic at 0146. Top Rider, same 3 EAMs and by for traffic at 0156 (Stegman-CA). N323BD-Gulfstream GV-SP bizjet, users unknown, given a radio check by Puerto Rico HFGCS, at 0238 (Stern-FL). Andrews-USAF HF-GCS control station, multi-transmitter Skyking message "6JG," at 1732 (PPA-Netherlands).
- 11176.0 Reach 579-USAF transport, calling Mainsail (any station), at 0730 (PPA-Netherlands). [The frequency changed 19 years ago. -Hugh]
- 11181.0 DL0005DAT-USAF E-3C Sentry #83-0005, an AWACS, ALE sounding at 0430 (PPA-Netherlands).
- 11184.0 5Y-KYF-Kenya Airways B737, flight KQ0511, HFDL position for Reykjavik, at 1905 (MPJ-UK).
- 11190.0 EP-IAD-Iran Air B747-SP86, selcal check with "Charlie Charlie" (company LDOC in Tehran), at 2020 (PPA-Netherlands).
- 11193.0 Moscow LDOC, Russia, selcal check FK-HJ with Transaero Airlines EI-XLG, a B747, at 0433 (PPA-Netherlands).
- 11205.0 Ascot 3669-UK Royal Air Force transport, calling Tascomm flight watch, also on 11217, at 2044 (PPA-Netherlands).
- 11217.0 GAF 163-German Air Force aircraft, calling DHM 91, also on 11265, at 1819 (PPA-Netherlands).
- 11220.0 Ascension-USAF, Wideawake Field, Ascension Island, calling Lajes, Azores, at 2023 (PPA-Netherlands). Offutt-USAF HFGCS, Offutt AFB, NE, attempting a secure patch with Air Mobility Command transport Reach 253, went to 12093, back to 11220, then tried 12109, all starting at 2105 (Stern-FL).
- 11232.0 Trenton Military-Canadian Forces, passing airfield weather to Canforce 4004, at 1809 (PPA-Netherlands).
- 11253.0 GQF-RAF Volmet, Inskip, aviation weather at 0812 (PPA-Netherlands).
- 11256.0 ETH701-Ethiopian Airlines flight ET701, a B767 reg ET-ANU, reporting delay to Holloway LDOC, Addis Ababa, at 2045 (PPA-Netherlands).
- 11318.0 Syktyvkar Volmet, identifying in Russian at 0733 (Lacroix-France).
- 11348.0 N419MC-Atlas Air B747-48EF freighter, flight 5Y0616, HFDL position for Canarias, at 2008 (MPJ-UK).
- 11430.0 New Star (V13), in progress at 0514, 0610, and 1300 (Boender-Hong Kong).
- 11494.0 LNT-CAMSLANT, calling 001 (USCG HC-130J #2001), ALE on COTHEN, at 1600. LNT, calling F04 (USCG HU-25C+ # 2104), ALE at 1635 (MDMonitor-MD).
- 12087.0 N010HN-US National Guard, NH, calling N011HNEMERGEN, also NH National Guard, ALE at 1756 (Metcalfe-KY).
- 12109.0 Offutt, came from 12220 with Reach 253, went secure and did the patch, at 2115 (Stern-FL).
- 12160.0 H401-Moroccan military, calling C3, ALE at 0750 (Lacroix-France).
- 12222.0 219-USCG Sector Corpus Christi, TX, calling F05 (USCG HU-25D Falcon Jet #2105), at 0016 (MDMonitor-MD).
- 12353.0 WPE Jacksonville-Crowley Marine, getting status of a vessel at 2210 (Stern-FL).
- 12431.0 GWPWN33-Brazilian Navy, Natal calling GWPWSB and GWPWAE, also on 12437, ALE at 0851 (Lacroix-France). CAGLIARI-Italian Financial Police, Cagliari, working LOMBARDI, Coast Guard Patrol Boat *Lombardi*, at 1436 (MPJ-UK).
- 12577.0 ZCDQ5-Bermuda flag cargo vessel *Cala Pira*, setting up call on 12990 simplex with ZCDQ4, cargo vessel *Cala Paradiso*, DSC at 1804 (MPJ-UK).
- 12637.5 XSG-Shanghai Radio, China, CW marker at 1543 (Lacroix-France).
- 12750.0 CWA-Cerrito Radio, Uruguay, CW weather observations in Spanish, at 0019 (Filippi-NJ).
- 12843.0 HLO-Seoul Radio, Korea, weak CW marker at 1027 (Filippi-NJ).
- 13110.0 HLO-ShipCom, AL, "female" voice-synthesized weather for Caribbean and Bahamas, at 1112. WLO, voice announcing traffic for vessel Avenger, parallel on 13152, at 1304 (Filippi-NJ).
- 13270.0 B-6076-Air China A330, flight CCA940, HFDL position for Hat Yai, Thailand, at 1934 (MPJ-UK).
- 13427.1 Unid-Russian Polytone (XPA2), multiple FSK tone coded message in 5-figure groups, at 1910 (PPA-Netherlands).
- 13446.0 FCOFEM-FEMA Region 10, WA, ALE sounding at 0441. FC6FEM, Region 6, TX, sounding at 0457. FC4FEM, Region 4, GA, sounding at 0459 (PPA-Netherlands).
- 13528.0 "C"-Russian Navy cluster beacon (MX), Moscow, CW identifier at 0009 (Filippi-NJ).
- 13528.4 "M"-Russian Navy CW cluster beacon (MX), Magadan, at 1305 (Boender-Hong Kong).
- 13927.0 AFA5QW-USAF MARS, IN, working (unintelligible) 42, self-identified as a U-2, at 1815. Evac 626-Probable partial call of a USAF Air Evac mission, looking for a patch with USAF MARS AFA6GG (TX), AFA4QK (TN), and then AFA9AY, CA; at 2140 (Stern-FL).
- 14396.5 NCS 202-NCS, FL, controlling SHARES Region IV weekly net; checking in AARONM (US Army MARS), NNNOMB (US Navy/ Marine Corps MARS), and NCS 312 (NCS), at 1500 (MDMonitor-MD).
- 14411.0 RDL-Russian military strategic broadcast, many short, coded messages in FSK Morse, at 1349 (MPJ-UK).
- 14452.5 CIW650-Canadian Forces Affiliate Radio System, net with 327, 444, and 624; at 1648 (Metcalfe-KY).
- 14455.0 KHA946-NASA Michoud Assembly Facility, LA; weekly net with KHA925, Johnson Space Center, TX; and KHA959, NASA Wallops Island Flight Facility, VA; at 1635 (Metcalfe-KY).
- 14484.0 Desert Eagle-Probable US Army MARS control station in southwestern US, radio check with Showdown 393, exercise or net call for another MARS station, at 1515 (MDMonitor-MD). [All these "Showdowns" and the other western-movie call signs appear to be a new MARS emergency net with government and military agencies. -Hugh]
- 15867.0 Z01-USCG Sector Northern New England, calling F35 (USCG Falcon Jet #2135), ALE on COTHEN, at 1839 (MDMonitor-MD).
- 16402.0 ABA-Maltese Navy squadron headquarters, Hay Wharf, ALE text message for AB2, Patrol Boat P-22, at 1431 (MPJ-UK).
- 16806.5 NMF-USCG comm station, Boston, weather in SITOR-B at 1632 (Lacroix-France).
- 17478.5 NJT-21st WMD-CST, NJ, calling DTRA1, Defense Threat Reduction Agency, VA, at 2016 (Metcalfe-KY).
- 17928.0 "16"-HFDL ground station, Canarias, Canary Islands, loud squitters but no traffic, at 2057 (MPJ-UK).
- 17967.0 VP-BRX-Aeroflot A320, flight SU1530, HFDL log-on with Al-Muharrqa, at 2004 (MPJ-UK).
- 26374.7 Unid-"Freeband" AM chatter in Spanish, with whistles, distorted music, recorded horse neigh, and other bizarre electronic sounds, at 2208 (Stegman-CA).







# Antenna Secrets I Wish I'd Known

**N**ow that Field Day 2012 is over, the customary “post-game” analysis took place at a nearby Wendy’s restaurant over an unending supply of chili. A local group of hams did amazingly well this year score-wise, despite relatively horrible propagation on any bands other than 20 and 40 meters.

One recurring issue is the group’s tradition of putting up an aluminum tri-band beam for the high bands. The group’s founding fathers feel strongly that the directivity and gain will provide an edge in signal strength. Which brings me to this month’s topic: antenna secrets I wish I’d know when I was a beginner.

It’s been my experience that the real world nuts and bolts of antennas sometimes seem to contradict conventional wisdom. In future columns I plan to cover the surprisingly tricky and controversial world of antenna radiation patterns and wave angle information, so I will only touch on them here briefly.

### A beam may not be the best Field Day antenna

My contention is that a beam isn’t worth the effort and *danger* required to erect it under field conditions. First, the energy and effort required to disassemble, transport, assemble, tune and erect a full-size aluminum tri-bander is considerable. Second, because Minnesota is centrally located in relation to almost all Field Day “action,” a beam is probably detrimental to the Field Day “contest-style” on-air process. Third, towers and beams are sometimes erected during real emergency operations, but they’re far from the norm and are almost always unnecessary from a communications quality perspective.

The biggest perceived advantage for the beam is directivity and signal strength. If you were working Field Day from Hawaii or Alaska, where almost every station is in one general direc-



*From southeastern Minnesota, a typical beam antenna aimed at New York puts most of the rest of the country off the side or back of the pattern, reducing signal strength or forcing frequent re-aiming. See text.*

tion and suitably distant to take advantage of the beam’s gain, directivity and coverage zones, the beam is definitely useful (or even necessary). The same may hold true if operating from one of the continental four corners such as Maine, Florida, southern California or Washington.

But, from Minnesota, if the beam is aimed at New York, for example, two-thirds of the country is off the side or back of the beam, so when stations from Texas, Arizona or Oregon call, they’re probably below the signal levels that would be provided by a basic inverted vee or dipole, and almost certainly below the levels provided by a horizontal loop.

When centrally located, the temptation is to twirl the beam from QSO to QSO, which adds complexity and probably hurts QSO rates. With all of the lower 48 states falling within 1500 miles, the tri-bander may actually make things worse. It certainly adds complexity, and simply putting it up and taking it down increases danger!

A pair of dipoles or inverted vees (so you can instantly switch between fixed patterns) has made an excellent Field Day antenna setup for Midwestern stations since Field Day One. If I were planning a Field Day outing in this neck of the woods I’d put up a horizontal loop (or two, one sized for 80-40, one for 20-10) fed with open-wire line and an autotransformer. These antennas provide excellent signals in all directions, on all bands (roughly equivalent to tri-band beams) and require no rotating whatsoever. But then, I *am* a horizontal loop evangelist. See my columns for April, May and October of 2011 for more information.

### A low beam may be no better than no beam

Ground-mounted verticals aside, a “low beam” is often a “no beam.” That is, to achieve textbook gain and directivity, typical Yagi beams must be installed at least a half wavelength above RF ground.

Installing Yagis at heights above a half wavelength can make them work better over certain (often longer) paths and poorer over other (often shorter) paths, but for our basic discussion, the important thing to remember is the “half wavelength minimum.”

For 20 through 6 meters this is fairly easy to achieve. A half wavelength at 20 meters is only 10 meters, about 33 feet. For a 10-meter beam a half wavelength is only 5 meters, about 16 feet.

In looking ahead to a future column, it’s interesting to note that a tri-band beam mounted at 33 feet meets the minimum height requirement for “expected beam behavior” on 20 meters (a

half wavelength), but when used on 10 meters the antenna is actually a full wavelength above the ground. At these heights the tri-bander exhibits gain and directivity in the direction in which it’s pointing, but the antenna’s response to signals of varying distances changes between a half wavelength and a full wavelength.

If you had a 200-foot tower with identical Yagis mounted every 40 feet (assuming they were aimed in the same direction and that feed line losses were normalized), signal strengths would vary from antenna to antenna, and the highest antenna would not always produce the strongest signal! This isn’t intuitive, but it’s true.

That’s why beams for 80 and 40 meters don’t work up to spec when they’re mounted at low heights. The same goes for any conventional, non-vertical antenna. If it’s not mounted at a half wavelength or more, forget about textbook radiation patterns, predictable performance, etc. Antennas mounted below certain minimum heights tend to be more omnidirectional. They still radiate, of course, but predicting exactly how and where is anybody’s guess.

### Size does matter

With few exceptions, the bigger an antenna is (in length and wire/element diameter), the better it performs. A 50-foot vertical whip works better than a 15-footer, which works better than a five-footer. If you could make a full-size antenna from solid copper wire (or hollow copper pipe) the diameter of a telephone pole, it would outperform a similarly sized antenna made from the highest quality conventional antenna wire (assuming all other variables such as height, RF power, etc. were the same).

Taken to extremes, however, the physics no longer hold true. A dipole antenna made with 30 miles of wire (say, 15 miles on a side) probably won’t work better than a dipole cut for 160 meters. Actually, it might not do much of anything! A similar limit exists for vertical antennas. Once the length of the radiating element exceeds 5/8-wavelength or so, almost all of the radiated energy goes straight up off the end of the vertical element. Unless you’re working through an overhead satellite, a 300-foot vertical for 10 meters is pretty much useless for terrestrial QSOs.

The most important practical take-away in this section is that physically small antennas tend to really suffer in performance. An 8-foot vehicle-mounted whip antenna might be 90% efficient at 10 meters (and work great), but only 5% efficient on 80 meters (and work not so great), despite the fact that it loads and tunes just fine.



Just because an antenna, through loading coils, antenna tuners or other impedance-matching wizardry, can be made to tune and load properly (“take power”), doesn’t mean it will radiate that power efficiently (perform well as an antenna instead of a dummy load).

Potential exceptions to the size rule are magnetic loops, but in general, full-size antennas rule the day.

### Take it outside

Unfortunately for condo dwellers such as myself, outdoor antennas almost always outperform indoor antennas. Although a 6-meter dipole inside the presidential suite of a skyscraper may work better than a similar outdoor dipole 10 feet off the ground, try to put up some kind of outdoor antenna if at all possible. An invisible or somewhat stealthy outdoor antenna almost always trumps its indoor counterparts.

### Towers and skyhooks to the rescue

Within the above-mentioned limits, in general, the higher an antenna is, the better it performs. This isn’t *always* true, of course, especially when you’re trying to work nearby stations on the lower HF bands and want a commanding signal (in which case, you’ll make use of NVIS – near vertical incidence skywave).

If you’re only looking to work stations out to 200 miles, say, a 40-meter dipole that’s six feet off the ground will dramatically outperform a dipole at 66 feet (the requisite half wavelength). For contacts outside the local region, however, the standard-height dipole is an easy winner.

Having your antenna outside and up in the air (or atop a tower) has an added benefit that isn’t immediately apparent: Unwanted RFI is greatly minimized compared to similar antennas mounted indoors or much closer to the ground.

### Resonant antennas don’t necessarily work better

For decades I thought (incorrectly), as many hams do, that resonant antennas radiate RF signals better than non-resonant antennas – that there was RF magic in the simple act of resonance. Amazingly, this is just not true!

Resonance imparts several characteristics that are useful and important in many other ways, but the radiation efficiency of your wire antenna elements, within reason, isn’t one of them.

I’m simplifying a lot here, but if we imagine operating on 40 meters with two wire dipoles, one “resonant” at 40 meters and one “resonant” at 60 meters, both antennas will radiate “all” (let’s say 99%) of the energy fed to them, resonant or not. The radiation patterns of the antennas will be different and will vary with height, ground type, etc, but “all” of the RF energy fed to each dipole will be radiated.

The efficiency of the feed line and any impedance-matching techniques (baluns, tuners, inductors) can vary greatly, and it’s *these losses* that we often wrongly associate with the desirability of using resonant antennas.

It’s better to think of radiation efficiency in terms of “percentage of full size,” with a full-size antenna being “100% efficient” and antennas smaller than full size being proportionally less

efficient. That helps to explain why an 8-foot vehicle whip works well on 10 meters (where a full-size quarter-wavelength vertical is about 8.5 feet) and not so well on 80 meters (where a full-size quarter-wavelength vertical is about 69 feet).

Using the same antenna on the bands in-between shows an expected reduction in efficiency as we go down in frequency. It’s no surprise, then, that using short vehicle whips works best from 20 meters an up. On the low bands the antenna is just too small to be efficient, even if it can be matched to whatever feed line you’re using.

In the same way, from an efficiency perspective, when using an antenna tuner to feed a dipole on multiple bands, the dipole should be “full size” on the lowest band of operation.

### Balanced antennas are easier

For beginners, balanced antenna designs such as dipoles, loops, triangles and vees are easier to successfully build and use than unbalanced antennas such as verticals, end-fed wires, random wires and the like. Achieving an efficient RF ground for unbalanced antennas can be difficult to impossible for non-experts, while balanced antenna designs need no RF ground to perform as intended.

### Use coax only for low-SWR installations

Contrary to popular convention, coaxial cable is only suitable for low-SWR installations. For example, feeding a 40-meter dipole with 50-ohm coax works great (on 40 or 15 meters, where the SWR is reasonable), but using the same antenna and feed line on 80 meters – even with a fancy shack-mounted antenna tuner – is an SWR disaster! Almost all of your precious RF power will be used to heat up the coax instead of radiating into space.

If you can only put up a single wire antenna and need to use it on multiple bands, feed it with open-wire line or place an autocoil at the feed point of the antenna. Either solution is *far better* than using coax in a high-SWR situation. See my column in the October 2011 issue for more detail.

### Your antenna tuner belongs on the other end!

If your antenna tuner is in your shack, it’s probably on the wrong end of your feed line. To eliminate potentially devastating SWR losses, put your antenna tuner at the feed point of your antenna and not in your shack!

*As long as you’re willing to improvise a weather-proof housing, at \$179, SGC’s SG-239 autocoil is a real bargain in cost and performance.*

*This compact unit automatically tunes your antenna from 160 through 10 meters (many users also report success at 6 meters) with 1.5 to 200 W of RF output. With 170 memories, tuning is fast and accurate.*

*Shown here is the SG-239 being tested with an “up the tower” run of open-wire line by Kevin, ACOTA. A plastic kitchen container provides ultimate weather-proofing while an inverted plastic trash can is fitted on top for extra WX and UV protection (not shown). Yes, that’s RG-6 and RG-11 feeding all antennas on the tower!*



This arrangement lets you use your antenna on multiple bands, and because the SWR on the coax that runs between your radio and your antenna is always low, feed line losses are also low. There’s still loss in the tuner’s impedance-matching network, and the antenna’s efficiency is still impacted by its size (percentage of full size), but the “tuner at the feed point” approach is a huge step above the old-fashion “tuner in the shack” approach in most situations.

Antenna tuners designed for feed point installation are often called autocoilplers. They require dc power at the feed point (via separate wires or via a dc power injector connected to the coax that feeds RF), but they’re also completely automatic. You talk or hit the key and the auto-coupler matches the antenna for you in a few seconds or less.

Autocoilplers are available from SGC, Icom, Alinco, MFJ and elsewhere. See my column in the February 2011 issue for more details.

### 75-ohm RG-6 coax works great on HF!

Although it’s becoming more popular, most hams think 75-ohm satellite TV coax is just for satellite receiver and cable TV installation, and that 50-ohm “ham coax” must be used for legitimate HF and VHF work. Nothing could be further from the truth.

Performance-wise, 75-ohm RG-6 (or RG-6 quad shield) coax equals or bests all but the most expensive 50-ohm cables – but at a fraction of the cost. Other benefits include universal availability (any Wal-Mart, day or night) and easy, inexpensive connector installation (RG-6 connectors attach with inexpensive crimping tools or if you buy from Grove no tools are required as F-connectors and adapters are supplied.)



Unless you’re using the coax for precise phasing lines or in-line impedance-matching, the real world difference between a 50- or 75-ohm characteristic impedance is negligible. RG-6 will handle a kilowatt at 80 meters and an easy 200 W at 10 or 6 meters. If you need less loss or more beef, RG-6’s big brother, RG-11, will get the job done. RG-11 connectors are several dollars each (and require a dedicated crimping tool), but the performance and power-handling specs rival 50-ohm cables that cost three to four times as much.

I have used RG-6 exclusively on 160-6 meters for the past 10 years with fabulous results. You can, too. For more details, see my column in the March 2011 issue.

As hams we essentially never stop learning, so we will never run out of antenna secrets, but knowing the few discussed this month would have saved me *lots* of trial, error and teeth gnashing over the years. I hope they serve you in the same way!



# Beginner's Update: Antenna Lead-in

Over the last few years I've written on a number of subjects that occasionally need to be updated. This was brought to my attention recently by an email from longtime *MT* reader Martin Steindler who wrote to *MT* Publisher Bob Grove, "I have been a reader of *MT* for years and a shortwave listener for more than 60 years. You are to be highly commended for the quality and breadth of the articles in *MT*. However, one aspect of shortwave listening (and transmitting) is to feed the antenna (often and well described in *MT*) to the receiver/transmitter (also well described). But, no article in my memory has touched on the feed-through from the outside to the inside of the house/shack. This is not a trivial issue, especially in cold and wet climates, and can impact all sort of matching issues between antenna and receiver... Most of us cannot easily drill holes in outside walls to insert wires or connectors."

Martin is right, it's a critical issue and sometimes the main reason hams and SWLers don't bother to put up an outside antenna. The April 2010 *Beginner's Corner* (pages 30 and 31), titled "Your Antenna is Up: Now What?" takes a look at the issue of getting an outside antenna feedline into your house. Since that column was written there have been some additions to the number of options available, so this month I'll take a look at what's old and what's new.

### ❖ DIY Hole in the Wall

It was some 34 years ago that I started bringing antenna wires into the house. It started out innocently enough with a single coax cable for a VHF-UHF TV antenna. Later, an antenna rotator control wire was added, then single VHF and UHF cables. These were brought through the gable end vent at the peak of the house, where the antenna mast was located, and slipped through a small cut in the wire mesh that prevented bugs and other critters from making a home in the attic space. I had added a "drip loop," an extra few feet of coax and wire that dip below the entry point into the gable vent that prevented rain from following the coax into the attic space.

Then in 1984 I installed my first C-band satellite TV dish, a monstrously heavy ten foot fiberglass dish with all manner of cables: one for the LNA downconverter coax cable, a polarizing motor (three wires) and a dish drive that had two heavy duty DC wires and two sensor wires. They all had to be run from the dish into the house and to the satellite receiver.

In those days the preferred method was to run a two inch PVC pipe directly through the ex-

terior wall of the house followed by a 90 degree bend and then down below ground level (most such cables in those days were not direct-burial rated), another 90 degree bend and straight out to the dish where it was met by another 90 degree bend and straight up to the dish where the pipe was terminated in two final 90 degree bends (to prevent rain from flooding in). Sealant would be added to plug the hole and prevent critters from turning the pipe into a highway into your home.

Later, with the adoption of direct burial cable, a simple exterior wall plate would be fixed to the exterior and interior walls, and the cable bundle or ribbon would be buried a few inches below ground level and emerge out at the dish where it would be attached to the various components. This system also works well for amateur radio/SWL antenna lead in wires.

The UG363 bulkhead feed-through (pictured) can be a solution if you can drill one 5/8 inch diameter hole discreetly into your exterior wall (watch for hot electric wires behind the siding and sheetrock!). If you have to, drill two or three such holes to accommodate your antennas. But, once you get to three, you'll wonder why you didn't try one of MFJ's antenna solution panels.



**UG-363 Bulkhead 5/8 inch feed through will accept a PL-259 connector at both ends and comes in lengths from 1 inch (\$2) to 12 inches (\$19). Use individually or several in a piece of wood for a DIY multi-antenna window feed-through.** (Courtesy: Universal Radio)

### ❖ The All-purpose Antenna Window Feed-through

If you're a new ham or SWL, imagine that you'll eventually want to put up more than one outside antenna and need to feed it into the house. I didn't imagine such a thing and as a result I've got no fewer than five different places in the exterior walls where I have drilled holes and stuffed no fewer than 12 coax cables, rotator, sensor and ground wires that serve as lead-in for

longwave, HF, VHF/UHF and satellite antennas. I don't recommend that sort of hodge-podge approach if you can instead use something like MFJ's lineup of feed-through antenna window strips (see photos).

These antenna connector strips include connectors for up to six coax feeds and can accommodate PL, N and F connectors in various combinations. Some have ceramic connectors for twin-lead and random wire antennas as well. The MFJ-4605 (\$160 directly from MFJ Enterprises) is a two-tier connector feed with space for full cables to be inserted (no cutting cables or insertion loss). They are attached to a four foot long, pressure-treated piece of wood that is covered in exterior paint and has weather stripping attached.



**MFJ-4605 two-tiered feed-through (\$160) offers connectors in addition to whole cable feeds. Construction is the same as the other MFJ products.** (Courtesy: MFJ Enterprises)

To use these connector strips, just measure your window opening and cut the wood to fit. The finished connector leaves a professional looking installation (certainly compared to my random-holes-through-the-siding solution) and a secured window (by using a piece of wood you'll have to cut and insert between the other edge of the window and the frame either in a vertical or horizontal window configuration).

Installing one of these "ready-made" connector strips is not particularly easy. But then neither is drilling half a dozen holes in your exterior walls (again, watch out for electrical house wires inside the walls that you can't see!)



**MFJ-4603 antenna feed-through (\$80) is the deluxe version of the other two models. With the same wood, this model includes SO-239 jacks for HF/VHF, an N connector for VHF/UHF, one F connector for satellite TV, a balanced line twin feed on ceramic insulators, a random wire feed on a ceramic insulator, a ground wire connectors, a set of DC binding posts and a rubber-grommet channel for a rotator control cable (Cinch-Jones plug shown is not supplied).** (Courtesy: Universal Radio)



Reviews of the MFJ window feed-through solutions on eham.net were mixed. The 4603 model garnered a 3.8 out of 5 (hams either loved it or hated it), the 4602 also received a 3.8 out of 5, while the 4605 had only one review (a 4.0 out of 5).



**MFJ-4602 antenna feed through (\$65) is a variation on the 4601 model that has provisions for three SO-239 coax, one twin-lead, one random wire (both using ceramic insulators) and one ground feed-through. Like the 4601, this model is enamel painted, pressure-treated wood with weather stripping on the edges.** (Courtesy: Universal Radio)



**MFJ-4601 antenna feed-through (\$58) can handle as many as six coax-fed HF, VHF and/or UHF antenna leads and one ground lead into your house. Use it horizontally or vertically in spaces up to 48 inches. Comes with enamel painted, pressure-treated wood panel for a cut-to-size fit.** (Courtesy: Universal Radio)

You can make your own multi-connector window antenna feed-through by cutting a piece of wood to the exact window opening and drilling holes to accommodate a UG363 bulkhead feed-through (they come in lengths from 1 inch to 12 inches). You should be able to put six or more in a standard window opening. If you use a pressure treated 1 x 2, try the two-inch model (\$4 each); if you use a 2 x 4, try the three-inch long model (\$5 each). A length of adhesive-backed weather stripping on the top, bottom and sides of the wood should stop weather from coming in through the cracks.

## ❖ The Condo-Solution

Many hams operate in stealth mode from rented or leased condos. Home Owners Associations and landlords don't like to see renters drilling holes in the sides of their units. What's a ham or SWL to do? Try a Comet CTC-50M flat wire coax cable jumper. Again, as with the MJF solutions above, it may not be ideal, but it does work. The hams on eham.net gave it a 4.1 out of 5 (again, most loved the product while a few hated it). It's particularly useful if you're just trying to get one coax into the house (or apartment). It might not be so great trying to get four or more into the house. There's also a 100 watt limit on the amount of power you'll want to pass through the flattened wire.

The Diamond MGC50 window/door



**Diamond MGC50 (\$50) feed-through has SO-239 connectors at each end. It's designed for a maximum power output of 150 watts PEP SSB or 50 watts CW on HF, 40 watts FM on VHF, 30 watts on UHF and 10 watts from 900-1300 MHz.** (Courtesy: Universal Radio)

feed-through jumper looks very similar to the Comet CTC-50M, there's about a \$5 difference between the two. I would expect you will get similar results with either. Installation of either should be very easy and may be done on traditional sash windows or horizontal/vertical sliders. It should also work on patio or balcony sliding glass doors. The only problem is that you can accommodate only one antenna with one jumper.

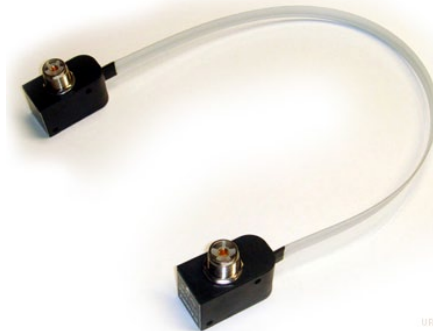

**Comet CTC-50M (\$46) feed-through has SO-239 connectors at each end can handle 100 watts PEP SSB on HF, 60 watts FM on VHF, 40 watts FM on UHF and 10 watts FM from 900-1,300 MHz.** (Courtesy: Universal Radio)

The above mentioned bulkhead feed-through solution could be perfect in a condo, but issues of where the wires go from your apartment or condo could be a big thing to overcome. The sight police have sharp eyesight! You might also have security issues as well.

## ❖ Security Issues

If properly done, the window feed-through panels should be secure; a piece of wood wedged into the gap between the window and the frame can prevent the window from being opening accidentally or by an intruder. But, it won't help if they throw a brick through the window and then slide it open: nothing would.

Still, having all those wires leading into a window in your house or apartment/condo could be an invitation to a thief to take a closer look. Anyone familiar with amateur radio equipment will know that much of the gear is expensive and there's a great deal of trading in

used (no questions usually asked) equipment. You may want to use an antenna connector panel on a window that's hidden from street view or has an AC unit or dense evergreen shrubs in front of it. In addition, many houses are protected by alarm systems that may not allow the use of such window feed-throughs.

Another security issue is lightning. Having antenna feeds coming directly from great height above your house could have the same results as having a lightning rod looped right through your house.

You can reduce the lightning threat by disconnecting all antennas from both sides of the feed-through and inserting each into a common ground rod installation such as the Alpha Delta USGC special copper grounding clamp (\$50).



**Alpha Delta antenna surge protectors (\$55 to \$75 each) and Alpha Delta USGC copper grounding clamp (\$50) in action (surge protectors ground rod and ground wires not included).** (Courtesy: Universal Radio)



# CCRadio-SW

## High Performance!

- Very Sensitive, Dual Conversion
- Bass, Treble, RF Gain Controls
- AM/SW 520kHz-30MHz, FM
- 50 Memories, Wide/Narrow Switch
- Built-in Twin Coil Ferrite™ Antenna
- External Antenna Jacks, AM-IF Out
- Built-in Battery Charger
- 12" Wide with Fold-Down Handle

~~\$149<sup>95</sup>~~ \$124<sup>95</sup> SALE

# C. CRANE

## Free Catalog

800-522-8863 • ccrane.com



# PROGRAMMING SPOTLIGHT

WHAT'S ON WHEN AND WHERE?

Fred Waterer

[fredwaterer@monitoringtimes.com](mailto:fredwaterer@monitoringtimes.com)

[www.doghousecharlie.com/radio](http://www.doghousecharlie.com/radio)

## Revisiting the Former Yugoslavia

In September 2006, my first *Programming Spotlight* column was published in *Monitoring Times*. In that first column, we shone the programming spotlight on the nations of the Former Yugoslavia. What has changed in the intervening six years? As we did then, let's tour the various republics in alphabetical order.

### Bosnia Herzegovina -

Now as then, Bosnia has no international service, but via the internet, one can hear the domestic service of Bosnian radio. Formerly known as the **Public Broadcasting Service of Bosnia-Herzegovina**, it is now known as **Radio-Television of the Federation of Bosnia and Herzegovina**. **Radio FBiH** can be found by going to [www.rtvfbih.ba/loc/](http://www.rtvfbih.ba/loc/). You can use Google Chrome to translate the page, or simply click on the "Live program Radii FbiH" link in the banner.

In early July I listened to some very mellow, almost "new age" music that wasn't quite pop and wasn't quite classical but fell somewhere in between. There were many references to Srebrenica, location of a notorious massacre during the ugly war in the region in the 1990s. As it turns out, I later learned that the 17<sup>th</sup> anniversary of the massacre was approaching which perhaps explains the almost somber music being played. Strictly local languages here, but it is an interesting listen nonetheless.

### Croatia -

**Glas Hrvatske** or **The Voice of Croatia** can be heard daily from 2200-0500 UTC on 9925 kHz via transmitters in Germany. It can also be heard online at [www.hrt.hr/streamf/HrstreamGH](http://www.hrt.hr/streamf/HrstreamGH). Brief English segments can be heard at 0200 UTC. Lots of music can be heard here, almost continuously. Like other stations from the region, the music is mostly light, pop music which wouldn't be out of place on any station in North America. Often the music incorporates traditional folk rhythms with modern electronic instruments. It is an entertaining fusion and quite a contrast. The music is so alive in a region that has seen so much death.

### Macedonia -

It is very easy to watch Macedonian television online ([www.mtv.com.mk/](http://www.mtv.com.mk/)), but I spent the better part of an hour going in circles, even with the help of Google Translate, trying to find a link to **Macedonian Radio**. What I did find was a page which linked to almost 40 Macedonian FM stations.



Picking one at random, I "tuned in" to **Radio Fortuna 96.8**. It is described as a soft pop station in Skopje, the capital. Like the other nations of the region, I was impressed with the variety of music to be heard. Songs that would never be played in North America, which, in many cases, is a real pity, as there is some very good music to be heard here. You can check out these Macedonian radio stations by going to <http://delicast.com/radio/Macedonia>. This site links to literally thousands of radio stations around the world and is well worth checking out!

### Montenegro -

Like 2006, Montenegro posed a problem when it came to finding audio. Montenegro or Crne Gore (Black Mountain) was the last republic to leave the Former Yugoslav state. **Radio Televizija Crne Gore** has a web presence but no audio links ([www.rtcg.me/lajnet.html](http://www.rtcg.me/lajnet.html)). However Mr. Google suggested the site [www.listenlive.eu/montenegro.html](http://www.listenlive.eu/montenegro.html) which provided a link to **Radio Crne Gore**, which I immediately fell in love with! The music was more local, more "folkish." I will definitely listen to this stream again. I enjoyed listening to the local language, here and throughout the region. I found that I could follow most of these languages, as they share many words with Russian and German, both of which I am familiar with.

### Slovenia -

**Radio Slovenia International** was an integral part of the program *Insight Central Europe*, a co-production of several broadcasters including **Radio Slovenia, Radio Slovakia, Radio Prague, Polish Radio, Hungarian Radio** and **Austrian**



The ICE Team from Radio Slovenia

**Radio**. The program was suspended in 2008, however the website is still active, but sadly the program links don't seem to work anymore. Check it out at <http://incentraleurope.radio.cz/>

I tuned in to **Radio Slovenia International** and found that the music was very similar to the music that I recalled from 2006. Such "famous Slovenians" as Will Smith were featured. Slovenia was the most Western leaning Yugoslav republic, so it is not surprising that it would feature more American and British music. I should mention that there was Slovenian music played as well, although it could have been from anywhere in the region as well.

I was pleasantly surprised to hear a bit of English, about 0530 UTC, during which a man gave a brief weather forecast for the region. Later there was an English segment discussing what makes a successful band. When I listened, there were frequent mentions of Maribor. This is a town in Slovenia that was caught in the crossfire of the Balkan Wars. (*Star Trek* fans will remember Maribor as Captain Jean Luc Picard's daughter in an alternative reality).

If you like Europop, and English language music, **SRI** is a good listen. If you prefer something more local, pop back across the border to Montenegro or to Serbia.

### Serbia -

Serbia is home to the old Federal Capital of Belgrade, and **International Radio of Serbia** is the successor to the old **Radio Yugoslavia**. Serbia continues to broadcast on shortwave to North America on 9685 kHz at 0030 UTC (except Sunday and Monday). At 0000 you can hear the Serbian language (on Sunday, Serbian replaces the English broadcast). News is dominated by two subjects which represent the Yin and Yang of Serbia; its longing to be part of Europe and its reluctance to give up Kosovo (which it refers to as Kosmet or Kosovo-Metohija). This is an open wound in Serbian-European relations.

You can listen to the most recent English



broadcast online, or watch the latest television news in English on demand, from the **International Radio of Serbia** website <http://voiceofserbia.org/>. You can also read the latest news in English via this website.

Also available online is the independent radio station **B92**. Originally begun as a youth oriented station in 1989, it became one of the few independent voices in Serbia during the Milosevic regime, and as a result has a wide following in Serbia to this day. It has a nice mix of music both Western and Serbian and is often an enjoyable listen. Give it a try at [www.b92.net/radio/](http://www.b92.net/radio/) (Click the mp3 link in the orange box under the masthead on the right, marked "Slušajte uživo").

The republics of the former Yugoslavia are fiercely independent, yet strive to be part of the European Union, and all seem to share similar tastes in music, if not in politics.

## ❖ Elsewhere...

**Out and About – Voice of Russia** This program is heard at 0100 on UTC Tuesdays. It is one of the "new breed" of **Voice of Russia** programs. This is not the **Radio Moscow** of the 1970s with its reports of tractor production. There are many new voices to be heard, and they all sound younger and hipper. **Marina Kosareva** hosts this fast-paced show, highlighting entertainment, culture, life in Russia and interesting things in Moscow and the rest of the country. In early July, the topic was an advertising website that is very popular among Russians, and what Russians are reading these days.

Other programs in the series looked at fast food in Russia and people's opinions about it, a Portuguese film festival in Moscow, and a gathering in St. Petersburg in honor of the anniversary of Michael Jackson's death. **Kosareva** presents the program in a very entertaining way. She reminds me of **Sook Yin-Lee** of **CBC Radio's** **DNTO** program. She brings a lot of enthusiasm and preparation to the show.

You can listen to the program on 9800 and 9665 kHz on UTC Tuesdays at 0100 (following the news). Listen to the live stream online at [http://english.ruvr.ru/radio\\_broadcast/schedule/](http://english.ruvr.ru/radio_broadcast/schedule/) or listen to archived shows from the series at [http://english.ruvr.ru/radio\\_broadcast/35614392/80826224.html](http://english.ruvr.ru/radio_broadcast/35614392/80826224.html)

Give this and other programs from the **Voice of Russia** a listen. Many new presenters can be heard, many of whom appear to be non-Russians. Newscasts are very well done and the newscasters would not be out of place at VoA or CNN. Russia is a happening place, tune in and see what you think!

**Slovakia Today – Radio Slovakia International** may have left the shortwave bands but their programming lives on. And if you believe as I do, that a computer is just a World Band Radio that does other things, you are still just a few clicks away from the programming of this interesting country in the heart of Europe.

Slovakia rarely makes headlines, but it pops up now and then. In April 2012 Team Slovakia almost pulled off a major upset at the World Hockey Championships, knocking off some powerful squads until finally being defeated in the finals by

Russia. Until the early 1990s, it formed the eastern part of Czechoslovakia. After the break-up of that country, **Radio Slovakia International** was a very reliable signal, but it has joined the increasing number of stations which have left the shortwave bands. While I miss the romance of carefully tuning them in, it is also rather nice to listen online with near FM quality.

Despite the budget cuts that have hit most major broadcasters, **Slovakia Today** is still a good program, although it does seem to cover fewer topics. In early July one program focused on a Slovak architect living in London, as well as other young Slovaks who have left the country seeking a life abroad. They also looked at a Slovak entry in the Olympic Art Festival. Listen online at [www.rozhlas.sk/radio-international-en](http://www.rozhlas.sk/radio-international-en)

**Radio Slovakia International** can also be heard via the **World Radio Network** daily at 1730 UTC. You can listen at [www.wrn.org](http://www.wrn.org) RSI is also heard via **WRMI** in Miami weekdays at 0030 UTC on 9955 kHz.

The Internet also allows one to hear many domestic programs that one couldn't hear before, even with a shortwave radio. The domestic network of **Slovak Radio** (Slovensky Rozhlas – Slovak is one of the few European languages that has its own word for "radio") has some very entertaining programming, even if one does not speak the language. I took a course in Slovak at university; sadly most of it has been lost to me over the intervening years. Nevertheless, one can often glean the gist of a program. A particularly good program is **Espresso**, heard on Saturdays at 0530 and 1930 Bratislava time (0330 and 1730 UTC), featuring music of "the golden age of Czech and Slovak pop music. Click on the link at [www.rozhlas.sk/radio-slovensko/ako-nas-pocuvat-internet#](http://www.rozhlas.sk/radio-slovensko/ako-nas-pocuvat-internet#). Then click the **Radio Slovakia** logo, which should take you to the live stream. Saturdays and Sundays especially provide the listener with lots of music and light entertainment. Give it a listen for something a bit out of the ordinary!

## ❖ Radio New Zealand

**Radio New Zealand International** is one of the best reasons to own a radio and a computer. In 1984 I managed to hear their then puny 7.5 kW transmitter...barely...just enough to get a QSL card. Later when they opened their more powerful 100 kW transmitter, listening became that much easier. I became a fan of tuning in to **RNZI** when conditions were favorable, and recall listening spellbound to (what I presume to have been) **Sounds Historical**, recounting the tragedy of the sinking of the car ferry **Wahine** in the late 1960s.

Over the years many hours were spent listening to the entertaining programming from this small island nation. Early in this century, with the advent of the Internet and streaming audio, I discovered not only **Radio New Zealand International**, available around the clock, but also the domestic networks of **Radio New Zealand**. A few years ago, I tuned in around Christmas for a Louis



Armstrong concert and discovered my perhaps all-time favorite program, which has been mentioned in this column before, **Matinee Idle** hosted by **Phil O'Brien** and **Simon Morris**.

**Matinee Idle** is only heard for a month or so around Christmas and on statutory holidays. You might say that the lunatics run the asylum, lots of fun, frivolity and both good music and amusingly bad music.

I particularly like the **Radio New Zealand** local morning program **Morning Report** which runs for three hours at 1800 UTC. It features news and interviews, Pacific news, rural news, sports, New Zealand newspapers, traffic and business news. It is presented by Geoff Robinson and Simon Mercep and gives one a unique insight into life in the South Pacific. [www.radionz.co.nz/national](http://www.radionz.co.nz/national)

## ❖ Alternative Sources of Programming

You never know where you might trip over an international broadcaster. For instance, my cable television provider here in Southern Ontario offers **Polish Radio**. A few months back, while surfing the various TV channels, I stopped on **Voiceprint**, a service for the blind, which to my surprise carried programming from **Radio Netherlands**. In Canada, **CBC Overnight** on the **Radio One** network, features programming from the **BBC** and **World Radio Network**. While it doesn't have the variety it once had, night owls can hear programming from the **BBC**, **CBC**, **ABC Australia** and others. The website is hopelessly outdated, for instance by clicking on the link to the "Latest Show" you get the programs from November 22, 2009! However, if you go to the **CBC Radio One** schedule, it is all spelled out (just make sure you select "Full Day" view).



While this schedule will be subject to change by the time you read this, in July one could hear programming such as: **From Our Own Correspondent**, the flagship reportage program of the **BBC** (at 3 am local), **Outlook (BBC)** at 330 am local time, and **Connect Asia (Radio Australia)** at 4 am weekdays. The **Australian Broadcasting Corporation's The Philosopher's Zone** can be heard Sundays at the same time.

I have given local times, since there are a number of potential time zones to choose from, beginning with Newfoundland Time on the East Coast all the way to Pacific Time on the West Coast.

**CBC** is not the only broadcaster to air international broadcasters over night. Many **PBS** stations do the same thing. **WNED 970** in Buffalo, New York, becomes a relay of the **BBC World Service** from 10 pm until 5 am Eastern on weekdays, Midnight until 6 am on Sundays, and 11 pm until 6 am on Saturdays. Many other **PBS** stations do this – as they say, check your local listings – you never know what gem you might discover or where!



## QSLing from the Most Wanted List

In amateur and shortwave radio circles, there are stations considered a snap to hear and verify, and then there are those at the top of the heap for "Most Wanted." Swains Island, north of Tutuila Island, America Samoa, is one of the most wanted islands to verify, and one whose availability occurs rarely.

Despite its small size and remote location, a multinational team will again activate Swains Island and operate on six fully functional stations for 14 days on 1.8-50 MHz, using SSB, CW and RTTY. They expect to arrive on the island and set up on September 4 and plan to begin operations as NH8S the following day.

Amateur radio operators and shortwave listeners can learn more about this historic

event on the team website at [www.nh8s.org](http://www.nh8s.org) Links include a log search, photos, bios, sponsorship, QSL information and much more.

The suggested frequencies are where the NH8S team will be *transmitting*, and most of the time they will likely not be listening on their

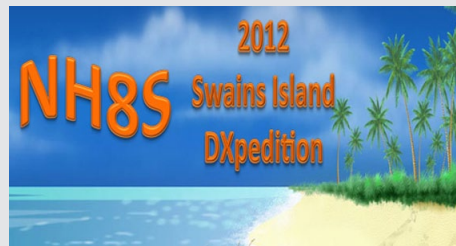

transmitting frequency. Remember to listen for their complete instructions before calling them.

One of the features of the Club Log is the Geo Propagation tab, which gives you an idea of what time and on what band listeners from your area are getting through to the DXpedition station. Logs for NH8S will be accessible via their website.

Plans are to cease operating on September 18 and return to Pago Pago on September 20. Questions should be sent to [info@nh8s.org](mailto:info@nh8s.org).

Don't miss this chance to verify Swains Island from the Most Wanted List.

### ALBANIA

Radio Tirana, 7465 kHz. Full data Native Costume design card, unsigned. Received in 250 days for an English report, \$2.00US and souvenir postcard. Station address: Rruga Ismail Qemali 11, Tirana, Albania (Frank Hillton, Charleston, SC). Website: <http://rtsh.al>

### CANADA

CFVP, 6030 kHz. Full data large cowboy/antenna logo card, signed by Harold Sellers, QSL Manager/ODXA. Received in 81 days for an English report and \$2.00US. QSL address: 3211 Centennial Drive, Apt. 23, Vernon, British Columbia V1T 2T8, Canada (Al Muick, PA). Email: [QSLCalgary@gmail.com](mailto:QSLCalgary@gmail.com).

Radio Japan/NHK World, 6110 kHz relay via Sackville. Full data squirrel card with site noted as "West Canada," unsigned. Received in 22 days for an English report and two IRCs. Station address: 2-1, Jinnan 2-chome, Shibuya-ku, Tokyo 150-8001, Japan (Bill Wilkins, Springfield, MO).

### FM/MEDIUM WAVE

KACV, 89.9 MHz FM. *Amarillo College's Cutting Edge*. Full data E-QSL from Trey Holt, Music Director. Mentioned power as 100 kW. Received in nine days for an e-report to [kacvfm90@actx.edu](mailto:kacvfm90@actx.edu) Station address: P.O. Box 447, Amarillo, TX 797178 USA (Joe Wood, Greenback, TN). Streaming audio [www.kacvfm.org/](http://www.kacvfm.org/)

KVNS, 1700 kHz AM. *Rio Grande Valley's Classic Hits*. Personal letter from Billy Santiago, Operations Manager. Received 81 days for an AM report. Station address: 1050 McIntosh, Brownsville, TX 78521 USA (Vashek Korinexi, South Africa/playdx).

WLW, 700 kHz AM. Full data station logo/antenna card, signed by Ted Ryan, Chief Engineer, [tedryan@clearchannel.com](mailto:tedryan@clearchannel.com) plus station stickers. Received in 25 days for an AM report and two US mint stamps. Station

address: 8044 Montgomery Rd., Suite 650, Cincinnati, OH 45236 USA (Rod Pearson, St. Augustine, FL). Streaming audio [www.700wlw.com](http://www.700wlw.com).

WMVP, 1000 kHz AM, ESPN. Partial data (no time) on computer-generated paper QSL from John Hurni, Chief Engineer. Received in nine days for an AM report, \$1.00US and address label (used on reply). Station address: 190 N. State St., Chicago, IL 60601-3302 USA (Wilkins).

WSCR, 670 kHz AM, *The Score Sports Radio*. Full data verification letter, signed by Mark Nielsen, Chief Operator. Received in 24 days for an AM report, \$1.00US and address label (not used for reply). Station address: 180 N. Stetson Ave., Suite 1250, Chicago, IL 60601 USA (Wilkins).

WWL, 870 kHz AM, *News-Talk-Sports*. Full data transmitter card, unsigned. Also received a coverage map and WWL 90<sup>th</sup> Anniversary info sheet. Received in one week for an AM report, \$1.00US (returned) and address label (used on reply). Station address: 400 Poydras St., Suite 900, New Orleans, LA 70130-3738 USA (Wilkins). Streaming audio [www.wwl.com/](http://www.wwl.com/)

### UTILITY

Croatia: DVN-NDB, 418 kHz. Full data prepared QSL card signed and stamped. Received in 36 days for a utility report. QSL address: Hrvatska kontrola zracne plovidbe o.o., Podružnica Split, p.p. 48, 21216 Split, Croatia (Partick Robic, Austria/UDXF).

Czech Rep.:LA-NDB, 514.5 kHz. Partial data verification letter and prepared QSL card signed and stamped by Capt. Ing. Rudolf Pavlik, Head of Radionavigation Service and Col. Ing. Miroslav Svoboda. Received in 20 days for a utility report. QSL address: Head of Radionavigation Service, Vojensky Utvar 5525, 67571 Namest nad Oslavu, Czech Republic. TRI-NDB Trogir, 378 kHz. Full data prepared QSL card signed and stamped.

Received in 36 days. QSL address same as DVN, 418 kHz (Robic).

Germany: AE1RD-US Army MARS Neidenbach, 6910 kHz. No data email reply from Daniel V. Wolff, Jr., US Army MARS regional Director. Received in one day for email to: [aem1wf@qsl.net](mailto:aem1wf@qsl.net) (Robic).

Greece: Leros Aero, 5637 kHz. Full data prepared QSL card signed and stamped. Received in 47 days for a utility report. QSL address: Civil Aviation Authority, Leros Airport 85400 Leros, Greece (Robic).

Hungary: TO-NDB, Zalaegerszeg/Andráshida, 358 kHz. Full data prepared QSL card signed and stamped. Received in 14 days for a utility report. QSL address: Gratis Közlekedési Kft., Air Traffic Services, Mártírok útja 22, 890 Zalaegerszeg, Hungary (Robic).

Italy: PIS-NDB, Pisa, 379 kHz. Full data prepared QSL card signed and stamped. Received in 33 days for a utility report. QSL address: Aeronautica Militare, 46 Brigata Aerea, gruppo Telecom, Il Capo Servizi Tlc, Viale Caduti di Kindú 1, 56100 Pisa, Italy (Robic).

USA: Air Force Mars Station-AIR-2. Armed Forces Day Test broadcast. Full data verification letter. Received in 30 days. QSL address: U.S. Air Force Military Auxiliary Radio System, Hancock Field Air National Guard Base, 6001 E. Molley Rd., Syracuse, NY 13211 USA (Ewald Glantschnig, Switzerland/UDXF).

### USA

WTWW, 9479 kHz. Full data E-QSL from George McClintock, President/Manager, [george@wtww.us](mailto:george@wtww.us). Received in 138 days for English report via postal mail, and follow up email. Station address: 1784 West Northfield Blvd., Murfreesboro, TN 37129 USA (Muick).





## HOW TO USE THE SHORTWAVE GUIDE

0000-0100 twhfa USA, Voice of America 5995am 6130ca 7405am 9455af  
 ① ② ⑤ ③ ④ ⑥ ⑦

### CONVERT YOUR TIME TO UTC

Broadcast time on ① and time off ② are expressed in Coordinated Universal Time (UTC) – the time at the 0 meridian near Greenwich, England. To translate your local time into UTC, first convert your local time to 24-hour format, then add (during Daylight Savings Time) 4, 5, 6 or 7 hours for Eastern, Central, Mountain or Pacific Times, respectively. Eastern, Central, and Pacific Times are already converted to UTC for you at the top of each hour.

Note that all **dates**, as well as times, are in UTC; for example, a show which might air at 0030 UTC **Sunday** will be heard on **Saturday** evening in America (in other words, 8:30 pm Eastern, 7:30 pm Central, etc.).

Not all countries observe Daylight Saving Time, not all countries shift at the same time, and not all program scheduling is shifted. So if you do not hear your desired station or program, try searching the hour ahead or behind its listed start time.

### FIND THE STATION YOU WANT TO HEAR

Look at the page which corresponds to the time you will be listening. English broadcasts are listed by UTC time on ①, then alphabetically by country ③, followed by the station name ④. (If the station name is the same as the country, we don't repeat it, e.g., "Vanuatu, Radio" [Vanuatu].)

If a broadcast is not **daily**, the days of broadcast ⑤ will appear in the column following the time of broadcast, using the following codes:

| Codes |                        |
|-------|------------------------|
| s/Sun | Sunday                 |
| m/Mon | Monday                 |
| t     | Tuesday                |
| w     | Wednesday              |
| h     | Thursday               |
| f     | Friday                 |
| a/Sat | Saturday               |
| occ:  | occasional             |
| DRM:  | Digital Radio Mondiale |
| irreg | Irregular broadcasts   |
| vl    | Various languages      |
| USB:  | Upper Sideband         |

### CHOOSE PROMISING FREQUENCIES

**Choose the most promising frequencies for the time, location and conditions.**

The frequencies ⑥ follow to the right of the station listing; all frequencies are listed in kilohertz (kHz). Not all listed stations will be heard from your location and virtually none of them will be heard all the time on all frequencies.

Shortwave broadcast stations change some of their frequencies at least twice a year, in April and October, to adapt to seasonal conditions. But they can also change in response to short-term condi-

tions, interference, equipment problems, etc. Our frequency manager coordinates published station schedules with confirmations and reports from her monitoring team and **MT** readers to make the Shortwave Guide up-to-date as of one week before print deadline.

To help you find the most promising signal for your location, immediately following each frequency we've included information on the target area ⑦ of the broadcast. Signals beamed toward your area will generally be easier to hear than those beamed elsewhere, even though the latter will often still be audible.

#### Target Areas

|     |   |
|-----|---|
| af: | Africa                                    |
| al: | alternate frequency (occasional use only) |
| am: | The Americas                              |
| as: | Asia                                      |
| ca: | Central America                           |
| do: | domestic broadcast                        |
| eu: | Europe                                    |
| me: | Middle East                               |
| na: | North America                             |
| pa: | Pacific                                   |
| sa: | South America                             |
| va: | various                                   |

### MT MONITORING TEAM

**Gayle Van Horn**  
 Frequency Manager  
[gaylevanhorn@monitoringtimes.com](mailto:gaylevanhorn@monitoringtimes.com)

**Larry Van Horn, MT Asst. Editor**  
[larryvanhorn@monitoringtimes.com](mailto:larryvanhorn@monitoringtimes.com)

#### Additional Contributors to This Month's Shortwave Guide:

*Thank You to ...*

BCL News; BDX Club; Cumbre DX; DSWCI/DX Window; Hard-Core DX; DX Re Mix News; BCDX/WWDX/Top News.

Adrian Peterson/AWR;  
 Alokesh Gupta, New Delhi, India; Ivo Ivanov, Bulgaria;  
 Nigel Holmes/R Australia;  
 Rachel Baughn/MT; Sean Gilbert UK/WRTH 2012;  
 Wolfgang Bueschel, Stuttgart, Germany.

### SHORTWAVE BROADCAST BANDS

| kHz         | Meters   |
|-------------|--|
| 2300-2495   | 120 meters (Note 1)  |
| 3200-3400   | 90 meters (Note 1)   |
| 3900-3950   | 75 meters (Regional band, used for broadcasting in Asia only)                                |
| 3950-4000   | 75 meters (Regional band, used for broadcasting in Asia and Europe)                          |
| 4750-4995   | 60 meters (Note 1)   |
| 5005-5060   | 60 meters (Note 1)   |
| 5730-5900   | 49 meter NIB (Note 2)  |
| 5900-5950   | 49 meter WARC-92 band (Note 3)   |
| 5950-6200   | 49 meters  |
| 6200-6295   | 49 meter NIB (Note 2)  |
| 6890-6990   | 41 meter NIB (Note 2)  |
| 7100-7300   | 41 meters (Regional band, not allocated for broadcasting in the western hemisphere) (Note 4) |
| 7300-7350   | 41 meter WARC-92 band (Note 3)   |
| 7350-7600   | 41 meter NIB (Note 2)  |
| 9250-9400   | 31 meter NIB (Note 2)  |
| 9400-9500   | 31 meter WARC-92 band (Note 3)   |
| 9500-9900   | 31 meters  |
| 11500-11600 | 25 meter NIB (Note 2)  |
| 11600-11650 | 25 meter WARC-92 band (Note 3)   |
| 11650-12050 | 25 meters  |
| 12050-12100 | 25 meter WARC-92 band (Note 3)   |
| 12100-12600 | 25 meter NIB (Note 2)  |
| 13570-13600 | 22 meter WARC-92 band (Note 3)   |
| 13600-13800 | 22 meters  |
| 13800-13870 | 22 meter WARC-92 band (Note 3)   |
| 15030-15100 | 19 meter NIB (Note 2)  |
| 15100-15600 | 19 meters  |
| 15600-15800 | 19 meter WARC-92 band (Note 3)   |
| 17480-17550 | 17 meter WARC-92 band (Note 3)   |
| 17550-17900 | 17 meters  |
| 18900-19020 | 15 meter WARC-92 band (Note 3)   |
| 21450-21850 | 13 meters  |
| 25670-26100 | 11 meters  |

#### Notes

- Note 1 Tropical bands, 120/90/60 meters are for broadcast use only in designated tropical areas of the world.
- Note 2 Broadcasters can use this frequency range on a (NIB) non-interference basis only.
- Note 3 WARC-92 bands are allocated officially for use by HF broadcasting stations in 2007 WRC-03 update. After March 29, 2009, the spectrum from 7100-7200 kHz will no longer be available for broadcast purposes and will be turned over to amateur radio operations worldwide.
- Note 4

### "MISSING" LANGUAGES?

A **FREE** download to MTXpress subscribers, the online MTXtra Shortwave Guide is 115+ pages of combined language schedules, sorted by time. Print subscribers: add the MTXtra SW Guide to your subscription for only \$11.95. Call **1-800-438-8155** or visit [www.monitoringtimes.com](http://www.monitoringtimes.com) to learn how.

**0000 UTC - 8PM EDT / 7PM CDT / 5PM PDT**

|                   |   |          |                          |
|-------------------|---|----------|--------------------------|
| 0000 0030         | Egypt, R Cairo                          | 9965na   |                          |
| 0000 0045         | USA, BBG/Voice of America               | 7555as   |                          |
| 0000 0045         | India/AIR/External Service              | 6055as   | 9705as                   |
|                   |   | 9950as   | 11670as 13605as          |
| 0000 0045 DRM     | India/AIR/External Service              | 9950eu   |                          |
| 0000 0045         | USA, WYFR/Family R Worldwide            | 11650as  |                          |
| 0000 0056         | Romania, R Romania Intl                 | 9700na   | 11965na                  |
| 0000 0100         | Anguilla, University Network            | 6090na   |                          |
| 0000 0100         | Australia, ABC NT Alice Springs         | 4835do   |                          |
| 0000 0100         | Australia, ABC NT Katherine             | 5025do   |                          |
| 0000 0100         | Australia, ABC NT Tennant Creek         | 4910do   |                          |
| 0000 0100         | Australia, ABC/R Australia              | 12080pa  | 15160pa                  |
|                   |   | 15240pa  | 15415pa 17795pa 19000pa  |
|                   |   | 21740pa  |                          |
| 0000 0100         | Bahrain, R Bahrain                      | 6010me   |                          |
| 0000 0100         | Canada, CFRX Toronto ON                 | 6070na   |                          |
| 0000 0100         | Canada, CFVP Calgary AB                 | 6030na   |                          |
| 0000 0100         | Canada, CKZN St Johns NF                | 6160na   |                          |
| 0000 0100         | Canada, CKZU Vancouver BC               | 6160na   |                          |
| 0000 0100         | China, China R International            | 6020eu   |                          |
|                   |   | 6075as   | 6180as 7350eu 7415as     |
|                   |   | 9570na   | 11790as 11885as 13750as  |
|                   |   | 15125as  |                          |
| 0000 0100         | Malaysia, RTM Kajang/Traxx FM           | 7295do   |                          |
| 0000 0100         | Micronesia, V6MP/Cross R/Pohnpei        | 4755 as  |                          |
| 0000 0100         | New Zealand, R New Zealand Intl         | 15720pa  |                          |
| 0000 0100 DRM     | New Zealand, R New Zealand Intl         | 17675pa  |                          |
| 0000 0100         | Russia, Voice of Russia                 | 9665va   | 9800va                   |
| 0000 0100         | Spain, R Exterior de Espana             | 6055na   |                          |
| 0000 0100         | Thailand, R Thailand World Svc          | 15275na  |                          |
| 0000 0100         | UK, BBC World Service                   | 5970as   | 6195as                   |
|                   |   | 7395as   | 9410as 9740as 12095as    |
|                   |   | 15335as  | 15755as 17685as          |
| 0000 0100         | USA, Amer Forces Network/AFRTS          | 4319usb  |                          |
|                   |   | 5446usb  | 5765usb 7811usb 12133usb |
|                   |   | 12759usb | 13362usb                 |
| 0000 0100         | USA, FBN/WTJC Newport NC                | 9370na   |                          |
| 0000 0100 Sat/Sun | USA, WBCQ Monticello ME                 | 5110am   |                          |
| 0000 0100         | USA, WBCQ Monticello ME                 | 7490am   | 9330am                   |
| 0000 0100         | USA, WEWN/EWTN Irondale AL              | 11520af  |                          |
| 0000 0100         | USA, WHRI Cypress Creek SC              | 5920va   |                          |
|                   |   | 7315ca   | 9860na                   |
| 0000 0100         | USA, WINB Red Lion PA                   | 9265am   |                          |
| 0000 0100         | USA, WTWW Lebanon TN                    | 5755va   |                          |
| 0000 0100         | USA, WWCR Nashville TN                  | 4840eu   | 5935af                   |
|                   |   | 6875af   | 9980eu                   |
| 0000 0100         | USA, WWRB Manchester TN                 | 3185na   |                          |
|                   |   | 5050na   |                          |
| 0000 0100         | USA, WYFR/Family R Worldwide            | 17580as  |                          |
| 0000 0100         | Zambia, Christian Voice                 | 4965af   |                          |
| 0030 0100         | Australia, ABC/R Australia              | 17750as  |                          |
| 0030 0100         | USA, BBG/Voice of America               | 7430as   |                          |
|                   |   | 9715as   | 9780as 11725as 12005as   |
|                   |   | 15205as  | 15290as 17820as          |
| 0030 0100 mtwhf   | USA, WRMI/R Slovakia Intl relay         | 9955am   |                          |
| 0035 0045         | India, AIR/Aizawl                       | 5050do   | 7295do                   |
| 0035 0045         | India, AIR/Chennai                      | 4920do   |                          |
| 0035 0045         | India, AIR/Guwahati                     | 4940do   |                          |
| 0035 0045         | India, AIR/Hyderabad                    | 4800do   |                          |
| 0035 0045         | India, AIR/Imphal                       | 4775do   |                          |
| 0035 0045         | India, AIR/Port Blair/Andaman & Nicobar | 4760do   |                          |
| 0035 0045         | India, AIR/Shimla                       | 4965do   | 6020do                   |
| 0035 0045         | India, AIR/Thiruvananthapuram           | 5010do   |                          |

**0100 UTC - 9PM EDT / 8PM CDT / 6PM PDT**

|               |                                  |         |                         |
|---------------|----------------------------------|---------|-------------------------|
| 0100 0115 Sat | Canada, Bible Voice Broadcasting | 9490as  |                         |
| 0100 0130     | Vietnam, VO Vietnam/Overseas Svc | 6175na  |                         |
| 0100 0200     | Anguilla, University Network     | 6090na  |                         |
| 0100 0200     | Australia, ABC NT Alice Springs  | 4835do  |                         |
| 0100 0200     | Australia, ABC NT Katherine      | 5025do  |                         |
| 0100 0200     | Australia, ABC NT Tennant Creek  | 4910do  |                         |
| 0100 0200     | Australia, ABC/R Australia       | 12080pa | 15160pa                 |
|               |                                  | 15240pa | 15415pa 17750as 17795pa |
|               |                                  | 19000pa |                         |

|                   |                                  |          |                          |
|-------------------|----------------------------------|----------|--------------------------|
| 0100 0200         | Bahrain, R Bahrain               | 6010me   |                          |
| 0100 0200         | Canada, CFRX Toronto ON          | 6070na   |                          |
| 0100 0200         | Canada, CFVP Calgary AB          | 6030na   |                          |
| 0100 0200         | Canada, CKZN St Johns NF         | 6160na   |                          |
| 0100 0200         | Canada, CKZU Vancouver BC        | 6160na   |                          |
| 0100 0200         | China, China R International     | 6020eu   |                          |
|                   |                                  | 6175eu   | 9410eu 9470eu 9535as     |
|                   |                                  | 9570na   | 9580na 9675eu 9790na     |
|                   |                                  | 11870as  | 15125as 15785as          |
| 0100 0200         | Cuba, R Havana Cuba              | 6000na   | 6050na                   |
| 0100 0200         | Malaysia, RTM Kajang/Traxx FM    | 7295do   |                          |
| 0100 0200         | Micronesia, V6MP/Cross R/Pohnpei | 4755 as  |                          |
| 0100 0200         | New Zealand, R New Zealand Intl  | 15720pa  |                          |
| 0100 0200 DRM     | New Zealand, R New Zealand Intl  | 17675pa  |                          |
| 0100 0200         | Russia, Voice of Russia          | 9665va   | 9800va                   |
| 0100 0200         | Taiwan, R Taiwan Intl            | 11875as  |                          |
| 0100 0200         | UK, BBC World Service            | 7395as   | 9410as                   |
|                   |                                  | 9740as   | 11750as 12095as 15310as  |
|                   |                                  | 15335as  | 15755as 17685as          |
| 0100 0200         | USA, Amer Forces Network/AFRTS   | 4319usb  |                          |
|                   |                                  | 5446usb  | 5765usb 7811usb 12133usb |
|                   |                                  | 12759usb | 13362usb                 |
| 0100 0200         | USA, BBG/Voice of America        | 7430as   |                          |
|                   |                                  | 9780as   | 11705as                  |
| 0100 0200         | USA, FBN/WTJC Newport NC         | 9370na   |                          |
| 0100 0200         | USA, KJES Vado NM                | 7555na   |                          |
| 0100 0200 Sat/Sun | USA, WBCQ Monticello ME          | 5110am   |                          |
| 0100 0200         | USA, WBCQ Monticello ME          | 7490am   | 9330am                   |
| 0100 0200         | USA, WEWN/EWTN Irondale AL       | 11520af  |                          |
| 0100 0200 m       | USA, WHRI Cypress Creek SC       | 9605na   |                          |
| 0100 0200         | USA, WHRI Cypress Creek SC       | 9840na   |                          |
|                   |                                  | 9860na   |                          |
| 0100 0200         | USA, WINB Red Lion PA            | 9265am   |                          |
| 0100 0200 irreg   | USA, WRNO New Orleans LA         | 7505am   |                          |
| 0100 0200         | USA, WTWW Lebanon TN             | 5755va   |                          |
| 0100 0200         | USA, WWCR Nashville TN           | 3215eu   | 4840na                   |
|                   |                                  | 5890af   | 5935af                   |
| 0100 0200         | USA, WWRB Manchester TN          | 3185na   |                          |
|                   |                                  | 5050na   |                          |
| 0100 0200         | Zambia, Christian Voice          | 4965af   |                          |
| 0120 0200 mtwhfa  | Sri Lanka, SLBC                  | 6005as   | 9770as 15745as           |
| 0130 0200 twhf    | Albania, R Tirana                | 7425na   |                          |
| 0130 0200         | Myanmar, Thazin BC Sta           | 6030do   |                          |
| 0130 0200 mtwhfa  | USA, BBG/Voice of America        | 7465ca   |                          |
|                   |                                  | 9820sa   |                          |
| 0140 0200         | Vatican City State, Vatican R    | 9580as   | 11730as                  |

**0200 UTC - 10PM EDT / 9PM CDT / 7PM PDT**

|                  |                                   |         |                         |
|------------------|-----------------------------------|---------|-------------------------|
| 0200 0230        | Thailand, R Thailand World Svc    | 15275na |                         |
| 0200 0230        | USA, KJES Vado NM                 | 7555na  |                         |
| 0200 0230 Sat    | USA, WBCQ Monticello ME           | 5110am  |                         |
| 0200 0300        | Anguilla, University Network      | 6090na  |                         |
| 0200 0300 twhf   | Argentina, RAE                    | 11710am |                         |
| 0200 0300        | Australia, ABC NT Alice Springs   | 4835do  |                         |
| 0200 0300        | Australia, ABC NT Katherine       | 5025do  |                         |
| 0200 0300        | Australia, ABC NT Tennant Creek   | 4910do  |                         |
| 0200 0300        | Australia, ABC/R Australia        | 12080pa | 15160pa                 |
|                  |                                   | 15240pa | 15415pa 17750as 17795pa |
|                  |                                   | 19000pa |                         |
| 0200 0300        | Bahrain, R Bahrain                | 6010me  |                         |
| 0200 0300        | Canada, CFRX Toronto ON           | 6070na  |                         |
| 0200 0300        | Canada, CFVP Calgary AB           | 6030na  |                         |
| 0200 0300        | Canada, CKZN St Johns NF          | 6160na  |                         |
| 0200 0300        | Canada, CKZU Vancouver BC         | 6160na  |                         |
| 0200 0300        | China, China R International      | 11770as |                         |
|                  |                                   | 13640as |                         |
| 0200 0300        | Cuba, R Havana Cuba               | 6000na  | 6050na                  |
| 0200 0300        | Egypt, R Cairo                    | 9720na  |                         |
| 0200 0300        | Malaysia, RTM Kajang/Traxx FM     | 7295do  |                         |
| 0200 0300        | Micronesia, V6MP/Cross R/Pohnpei  | 4755 as |                         |
| 0200 0300        | New Zealand, R New Zealand Intl   | 15720pa |                         |
| 0200 0300 DRM    | New Zealand, R New Zealand Intl   | 17675pa |                         |
| 0200 0300        | Palau, T8WH/World Harvest R       | 17800as |                         |
| 0200 0300        | Philippines, R Pilipinas Overseas | 11880me |                         |
|                  |                                   | 15285me | 17700me                 |
| 0200 0300        | Russia, Voice of Russia           | 9665va  | 15425na                 |
| 0200 0300        | South Korea, KBS World R          | 9580sa  |                         |
| 0200 0300 mtwhfa | Sri Lanka, SLBC                   | 6005as  | 9770as 15745as          |



|                   |                                     |          |         |
|-------------------|-------------------------------------|----------|---------|
| 0200 0300         | Taiwan, R Taiwan Intl               | 5950na   | 9680na  |
| 0200 0300         | UK, BBC World Service               | 6005af   | 6195me  |
|                   | 12095as                             | 15310as  | 17790as |
| 0200 0300         | USA, Amer Forces Network/AFRTS      | 4319usb  |         |
|                   | 5446usb                             | 5765usb  | 7811usb |
|                   | 12759usb                            | 13362usb |         |
| 0200 0300         | USA, FBN/WTJC Newport NC            |          | 9370na  |
| 0200 0300 Sat/Sun | USA, WBCQ Monticello ME5110am       |          |         |
| 0200 0300         | USA, WBCQ Monticello ME7490am       | 9330am   |         |
| 0200 0300         | USA, WEWN/EWTN Irondale AL          | 11520af  |         |
| 0200 0300         | USA, WHRI Cypress Creek SC          | 5920va   |         |
| 0200 0300         | USA, WINB Red Lion PA               | 9265am   |         |
| 0200 0300 irreg   | USA, WRNO New Orleans LA            | 7505am   |         |
| 0200 0300         | USA, WTTW Lebanon TN                | 5755va   |         |
| 0200 0300         | USA, WWCR Nashville TN              | 3215eu   | 4840na  |
|                   | 5890af                              | 5935af   |         |
| 0200 0300         | USA, WWRB Manchester TN             | 3185na   |         |
|                   | 5050na                              |          |         |
| 0200 0300         | USA, WYFR/Family R Worldwide        | 5985ca   |         |
|                   | 6115na                              |          |         |
| 0200 0300         | Zambia, Christian Voice             | 4965as   |         |
| 0215 0227         | Nepal, R Nepal                      | 5005do   |         |
| 0230 0300         | Myanmar, Myanma R/Yangon            |          | 9731do  |
| 0230 0300         | Vietnam, VO Vietnam/Overseas Svc    |          | 6175na  |
| 0245 0300         | Australia, HCB Global Australia     |          | 15400as |
| 0245 0300         | India, AIR/Bhopal                   | 4810do   |         |
| 0245 0300         | India, AIR/Guwahati                 | 4940do   |         |
| 0245 0300         | India, AIR/Hyderabad                | 7420do   |         |
| 0245 0300         | India, AIR/Imphal                   | 4775do   | 7335do  |
| 0245 0300         | India, AIR/Itanagar                 | 4990do   |         |
| 0245 0300         | India, AIR/Jaipur 4910do            | 7325do   |         |
| 0245 0300         | India, AIR/Jeyppore                 | 5040do   |         |
| 0245 0300         | India, AIR/Kolkata                  | 4820do   | 7210do  |
| 0245 0300         | India, AIR/Kuresong                 | 4895do   |         |
| 0245 0300         | India, AIR/Lucknow                  | 4880do   | 7440do  |
| 0245 0300         | India, AIR/Shillong                 | 4970do   |         |
| 0245 0300         | India, AIR/Shimla                   | 4965do   | 6020do  |
| 0245 0300         | India, AIR/Thiruvananthapuram       |          | 5010do  |
| 0250 0300         | Vatican City State, Vatican R7305am |          |         |
| 0255 0300 Sun     | Swaziland, TWR Africa               | 3200af   |         |

**0300 UTC - 11PM EDT / 10PM CDT / 8PM PDT**

|               |                                     |         |         |
|---------------|-------------------------------------|---------|---------|
| 0300 0315     | India, AIR/Aizawl                   | 5050do  | 7295do  |
| 0300 0315     | India, AIR/Imphal                   | 4775do  | 7335do  |
| 0300 0315     | India, AIR/Itanagar                 | 4990do  |         |
| 0300 0315     | India, AIR/Shillong                 | 4970do  |         |
| 0300 0320     | Vatican City State, Vatican R7305am |         |         |
| 0300 0325 Sun | Swaziland, TWR Africa               | 3200af  |         |
| 0300 0330     | Egypt, R Cairo                      | 9720na  |         |
| 0300 0330     | Myanmar, Myanma R/Yangon            |         | 9731do  |
| 0300 0330     | Philippines, R Pilipinas Overseas   |         | 11880me |
|               | 15285me                             | 1770me  |         |
| 0300 0330     | Vatican City State, Vatican R7360af | 15460as |         |
| 0300 0355     | South Africa, Channel Africa        | 5980af  |         |
| 0300 0355     | Turkey, Voice of Turkey             | 6165as  | 9515va  |
| 0300 0356     | Romania, R Romania Intl             | 9645na  | 11795na |
|               | 11895as                             | 15340as |         |
| 0300 0400     | Anguilla, University Network        |         | 6090na  |
| 0300 0400     | Australia, ABC NT Alice Springs     |         | 4835do  |
| 0300 0400     | Australia, ABC NT Katherine         |         | 5025do  |
| 0300 0400     | Australia, ABC NT Tennant Creek     |         | 4910do  |
| 0300 0400     | Australia, ABC/R Australia          | 15160pa | 15240pa |
|               | 15415pa                             | 17750as | 21725pa |
| 0300 0400     | Bahrain, R Bahrain                  |         | 6010me  |
| 0300 0400     | Canada, CFRX Toronto ON             | 6070na  |         |
| 0300 0400     | Canada, CFVP Calgary AB             | 6030na  |         |
| 0300 0400     | Canada, CKZN St Johns NF6160na      |         |         |
| 0300 0400     | Canada, CKZU Vancouver BC           |         | 6160na  |
| 0300 0400     | China, China R International        |         | 9690am  |
|               | 9790na                              | 11770as | 13750as |
|               | 15120as                             | 15785as |         |
| 0300 0400     | Cuba, R Havana Cuba                 | 6000na  | 6050na  |
| 0300 0400     | Malaysia, RTM Kajang/Traxx FM       |         | 7295do  |
| 0300 0400     | Micronesia, V6MP/Cross R/Pohnpei    |         | 4755 as |
| 0300 0400     | New Zealand, R New Zealand Intl     |         | 15720pa |
| 0300 0400 DRM | New Zealand, R New Zealand Intl     |         | 17675pa |
| 0300 0400     | Oman, R Sultanate of Oman           |         | 15355af |
| 0300 0400     | Palau, T8WH/World Harvest R         |         | 17800as |

|                 |                                  |          |         |
|-----------------|----------------------------------|----------|---------|
| 0300 0400       | Russia, Voice of Russia          | 9665va   | 15424na |
| 0300 0400       | South Africa, Channel Africa     |          | 3345af  |
| 0300 0400 Sun   | Sri Lanka, SLBC                  | 6005as   | 9770as  |
| 0300 0400       | Taiwan, R Taiwan Intl            | 5950na   | 15320as |
| 0300 0400       | UK, BBC World Service            | 3255af   | 5875af  |
|                 | 6005af                           | 6145af   | 6190af  |
|                 | 9410me                           | 9750af   | 12035af |
|                 | 15310as                          | 15365as  | 17790as |
| 0300 0400       | USA, Amer Forces Network/AFRTS   |          | 4319usb |
|                 | 5446usb                          | 5765usb  | 7811usb |
|                 | 12759usb                         | 13362usb |         |
| 0300 0400       | USA, BBG/Voice of America        |          | 4930af  |
|                 | 6080af                           | 9855af   | 15580af |
| 0300 0400       | USA, FBN/WTJC Newport NC         |          | 9370na  |
| 0300 0400       | USA, WBCQ Monticello ME7490am    |          | 9330am  |
| 0300 0400       | USA, WEWN/EWTN Irondale AL       |          | 11520af |
| 0300 0400       | USA, WHRI Cypress Creek SC       |          | 5920va  |
|                 | 7385na                           | 9825va   |         |
| 0300 0400 irreg | USA, WRNO New Orleans LA         |          | 7505am  |
| 0300 0400       | USA, WTTW Lebanon TN             | 5755va   |         |
| 0300 0400       | USA, WWCR Nashville TN           | 3215eu   | 4840na  |
|                 | 5890af                           | 5935af   |         |
| 0300 0400       | USA, WWRB Manchester TN          |          | 3185na  |
|                 | 5050na                           |          |         |
| 0300 0400       | USA, WYFR/Family R Worldwide     |          | 11740ca |
| 0300 0400       | Zambia, Christian Voice          | 4965as   |         |
| 0330 0400       | Australia, ABC/R Australia       |          | 15515pa |
| 0330 0400       | Iran, VO Islamic Rep of Iran     | 11920eu  | 13650eu |
| 0330 0400       | Vietnam, VO Vietnam/Overseas Svc |          | 6175na  |
| 0335 0345       | India, AIR/Kolkata               | 4820do   | 7210do  |

**0400 UTC - 12AM EDT / 11PM CDT / 9PM PDT**

|               |                                  |          |         |
|---------------|----------------------------------|----------|---------|
| 0400 0430     | Iran, VO Islamic Rep of Iran     | 11920eu  | 13650eu |
| 0400 0430     | USA, BBG/Voice of America        |          | 9855af  |
| 0400 0457     | Germany, Deutsche Welle          | 6180af   | 7240af  |
|               | 9470af                           | 12045af  |         |
| 0400 0457     | North Korea, Voice of Korea      |          | 3560as  |
|               | 7220as                           | 9345as   | 9730as  |
|               | 13760as                          | 15180as  |         |
| 0400 0458     | New Zealand, R New Zealand Intl  |          | 15720pa |
| 0400 0458 DRM | New Zealand, R New Zealand Intl  |          | 17675pa |
| 0400 0500     | Anguilla, University Network     |          | 6090na  |
| 0400 0500     | Australia, ABC NT Alice Springs  |          | 4835do  |
| 0400 0500     | Australia, ABC NT Katherine      |          | 5025do  |
| 0400 0500     | Australia, ABC NT Tennant Creek  |          | 4910do  |
| 0400 0500     | Australia, ABC/R Australia       | 15160pa  | 15240pa |
|               | 15415pa                          | 15515pa  | 21725as |
| 0400 0500     | Bahrain, R Bahrain               |          | 6010me  |
| 0400 0500     | Canada, CFRX Toronto ON          | 6070na   |         |
| 0400 0500     | Canada, CKZN St Johns NF6160na   |          |         |
| 0400 0500     | Canada, CKZU Vancouver BC        |          | 6160na  |
| 0400 0500     | China, China R International     |          | 6020na  |
|               | 6080na                           | 17730va  | 17855va |
| 0400 0500     | Cuba, R Havana Cuba              | 6000na   | 6050na  |
| 0400 0500     | Malaysia, RTM Kajang/Traxx FM    |          | 7295do  |
| 0400 0500     | Micronesia, V6MP/Cross R/Pohnpei |          | 4755 as |
| 0400 0500     | Russia, Voice of Russia          | 13775na  | 15760me |
| 0400 0500     | South Africa, Channel Africa     |          | 3345af  |
| 0400 0500 Sun | Sri Lanka, SLBC                  | 6005as   | 9770as  |
| 0400 0500 DRM | UK, BBC World Service            |          | 3955eu  |
| 0400 0500     | UK, BBC World Service            | 3255af   | 5875af  |
|               | 6005af                           | 6190af   | 7310af  |
|               | 12035af                          | 12095me  | 15310as |
|               | 17790as                          |          | 15365as |
| 0400 0500     | USA, Amer Forces Network/AFRTS   |          | 4319usb |
|               | 5446usb                          | 5765usb  | 7811usb |
|               | 12759usb                         | 13362usb |         |
| 0400 0500     | USA, BBG/Voice of America        |          | 4930af  |
|               | 4960af                           | 6080af   | 12025af |
| 0400 0500     | USA, FBN/WTJC Newport NC         |          | 9370na  |
| 0400 0500     | USA, Overcomer Ministry          |          | 15750af |
| 0400 0500     | USA, WBCQ Monticello ME9330am    |          |         |
| 0400 0500     | USA, WEWN/EWTN Irondale AL       |          | 11520af |
| 0400 0500     | USA, WHRI Cypress Creek SC       |          | 5920va  |
|               | 7385na                           | 9825va   |         |
| 0400 0500     | USA, WTTW Lebanon TN             | 5755va   |         |
| 0400 0500     | USA, WWCR Nashville TN           | 3215eu   | 4840na  |
|               | 5890af                           | 5935af   |         |

|                 |                                 |         |
|-----------------|---------------------------------|---------|
| 0400 0500       | USA, WWRB Manchester TN         | 3185na  |
| 0400 0500       | Zambia, Christian Voice         | 4965as  |
| 0430 0500       | Myanmar, Thazin BC Sta          | 6030do  |
| 0430 0500 mtwhf | Swaziland, TWR Africa           | 3200af  |
| 0455 0500       | Nigeria, Voice of Nigeria       | 15120af |
| 0459 0500       | New Zealand, R New Zealand Intl | 11725pa |
| 0459 0500 DRM   | New Zealand, R New Zealand Intl | 11675pa |

**0500 UTC - 1AM EDT / 12AM CDT / 10PM PDT**

|                   |                                      |          |
|-------------------|--------------------------------------|----------|
| 0500 0527         | Germany, Deutsche Welle              | 5925af   |
| 0500 0530         | Japan, R Japan NHK World             | 5975eu   |
|                   | 6110na                               | 11970va  |
| 0500 0530         | Vatican City State, Vatican R11625af | 13765af  |
| 0500 0557         | North Korea, Voice of Korea          | 13650as  |
|                   | 15100as                              |          |
| 0500 0600         | Anguilla, University Network         | 6090na   |
| 0500 0600         | Australia, ABC NT Alice Springs      | 4835do   |
| 0500 0600         | Australia, ABC NT Katherine          | 5025do   |
| 0500 0600         | Australia, ABC NT Tennant Creek      | 4910do   |
| 0500 0600         | Australia, ABC/R Australia           | 13630pa  |
|                   | 15415pa                              | 15515pa  |
|                   |                                      | 21725as  |
| 0500 0600         | Bahrain, R Bahrain                   | 6010me   |
| 0500 0600         | Bhutan, Bhutan BC Svc                | 5030do   |
| 0500 0600         | Canada, CFRX Toronto ON              | 6070na   |
| 0500 0600         | Canada, CKZN St Johns NF6160na       |          |
| 0500 0600         | Canada, CKZU Vancouver BC            | 6160na   |
| 0500 0600         | China, China R International         | 6020na   |
|                   | 6190na                               | 11710af  |
|                   |                                      | 11895as  |
|                   |                                      | 15350as  |
|                   |                                      | 15465as  |
|                   |                                      | 17505va  |
|                   |                                      | 17730va  |
|                   |                                      | 17855va  |
| 0500 0600         | Cuba, R Havana Cuba                  | 6010na   |
|                   | 6060ca                               | 6125am   |
| 0500 0600         | Eqt Guinea, Pan Am BC/R Africa       | 15190af  |
| 0500 0600         | Germany, Deutsche Welle              | 9470af   |
|                   | 9850af                               | 11800af  |
| 0500 0600         | Malaysia, RTM Kajang/Traxx FM        | 7295do   |
| 0500 0600         | Micronesia, V6MP/Cross R/Pohnpei     | 4755 as  |
| 0500 0600         | Myanmar, Thazin BC Sta               | 6030do   |
| 0500 0600         | New Zealand, R New Zealand Intl      | 11725pa  |
| 0500 0600 DRM     | New Zealand, R New Zealand Intl      | 11675pa  |
| 0500 0600         | Nigeria, Voice of Nigeria            | 15120 ad |
| 0500 0600         | Russia, Voice of Russia              | 13755na  |
| 0500 0600         | South Africa, Channel Africa         | 7230af   |
| 0500 0600 Sat/Sun | Swaziland, TWR Africa                | 3200af   |
| 0500 0600         | Swaziland, TWR Africa                | 9500af   |
| 0500 0600         | Taiwan, R Taiwan Intl                | 5950na   |
| 0500 0600         | UK, BBC World Service                | 3255af   |
|                   | 6005af                               | 6190af   |
|                   |                                      | 9410af   |
|                   |                                      | 11945af  |
|                   |                                      | 12095me  |
|                   |                                      | 15310as  |
|                   |                                      | 15365as  |
|                   |                                      | 15420af  |
|                   |                                      | 17640as  |
|                   |                                      | 17790as  |
| 0500 0600 DRM     | UK, BBC World Service                | 3955eu   |
| 0500 0600         | USA, Amer Forces Network/AFRTS       | 4319usb  |
|                   | 5446usb                              | 5765usb  |
|                   |                                      | 7811usb  |
|                   |                                      | 12133usb |
|                   |                                      | 12759usb |
|                   |                                      | 13362usb |
| 0500 0600         | USA, BBG/Voice of America            | 4930af   |
|                   | 6080af                               | 12025af  |
|                   |                                      | 15580af  |
| 0500 0600         | USA, FBN/WTJC Newport NC             | 9370na   |
| 0500 0600         | USA, Overcomer Ministry              | 15750af  |
| 0500 0600         | USA, WBCQ Monticello ME9330am        |          |
| 0500 0600         | USA, WEWN/EWTN Irondale AL           | 11520af  |
| 0500 0600         | USA, WHRI Cypress Creek SC           | 5920am   |
|                   | 7385na                               | 9825va   |
| 0500 0600         | USA, WTTW Lebanon TN                 | 5755va   |
| 0500 0600         | USA, WWCN Nashville TN               | 3215eu   |
|                   | 5890af                               | 5935af   |
| 0500 0600         | USA, WWRB Manchester TN              | 3185na   |
| 0500 0600         | Zambia, Christian Voice              | 6065af   |
| 0530 0556 DRM     | Romania, R Romania Intl              | 11875eu  |
| 0530 0556         | Romania, R Romania Intl              | 9700eu   |
|                   | 21500eu                              | 17760eu  |
| 0530 0600         | Australia, ABC/R Australia           | 17750as  |
| 0530 0600         | Thailand, R Thailand World Svc       | 17770eu  |

**0600 UTC - 2AM EDT / 1AM CDT / 11PM PDT**

|                   |                                      |         |
|-------------------|--------------------------------------|---------|
| 0600 0627         | Germany, Deutsche Welle              | 15275af |
| 0600 0630         | Germany, Deutsche Welle              | 13780af |
| 0600 0630         | Myanmar, Thazin BC Sta               | 6030do  |
| 0600 0630 Sat/Sun | USA, WRMI/R Prague relay             | 9955ca  |
| 0600 0645 mtwhfa  | Vatican City State, Vatican R15595me |         |

|                   |                                      |          |
|-------------------|--------------------------------------|----------|
| 0600 0650         | New Zealand, R New Zealand Intl      | 11725pa  |
| 0600 0650 DRM     | New Zealand, R New Zealand Intl      | 11675pa  |
| 0600 0655         | South Africa, Channel Africa         | 15255af  |
| 0600 0657         | North Korea, Voice of Korea          | 7220as   |
|                   | 9345as                               | 9730as   |
| 0600 0700         | Anguilla, University Network         | 6090na   |
| 0600 0700         | Australia, ABC NT Alice Springs      | 4835do   |
| 0600 0700         | Australia, ABC NT Katherine          | 5025do   |
| 0600 0700         | Australia, ABC NT Tennant Creek      | 4910do   |
| 0600 0700         | Australia, ABC/R Australia           | 11945pa  |
|                   | 15240pa                              | 15415pa  |
|                   |                                      | 17750as  |
|                   |                                      | 21725as  |
| 0600 0700         | Bahrain, R Bahrain                   | 6010me   |
| 0600 0700         | Canada, CFRX Toronto ON              | 6070na   |
| 0600 0700         | Canada, CFVP Calgary AB              | 6030na   |
| 0600 0700         | Canada, CKZN St Johns NF6160na       |          |
| 0600 0700         | Canada, CKZU Vancouver BC            | 6160na   |
| 0600 0700         | China, China R International         | 11710af  |
|                   | 11870me                              | 11895as  |
|                   |                                      | 13660as  |
|                   |                                      | 15140me  |
|                   |                                      | 15350as  |
|                   |                                      | 15465as  |
|                   |                                      | 17505va  |
|                   |                                      | 17710as  |
| 0600 0700         | Cuba, R Havana Cuba                  | 6010na   |
|                   | 6060ca                               | 6125am   |
| 0600 0700         | Eqt Guinea, Pan Am BC/R Africa       | 15190af  |
| 0600 0700         | Malaysia, RTM Kajang/Traxx FM        | 7295do   |
| 0600 0700         | Micronesia, V6MP/Cross R/Pohnpei     | 4755 as  |
| 0600 0700         | Nigeria, Voice of Nigeria            | 15120af  |
| 0600 0700         | Papua New Guinea, R Fly              | 3915do   |
| 0600 0700         | Russia, Voice of Russia              | 21800pa  |
| 0600 0700 DRM     | Russia, Voice of Russia              | 11830eu  |
| 0600 0700         | South Africa, Channel Africa         | 7230af   |
| 0600 0700         | Swaziland, TWR Africa                | 6120af   |
| 0600 0700         | Swaziland, TWR Africa                | 3200af   |
| 0600 0700 Sat/Sun | UK, BBC World Service                | 6005af   |
|                   | 9410af                               | 12095va  |
|                   |                                      | 15105af  |
|                   |                                      | 15310as  |
|                   |                                      | 17640af  |
|                   |                                      | 17790as  |
| 0600 0700 DRM     | UK, BBC World Service                | 5875eu   |
| 0600 0700 mtwhf   | UK, BBC World Service                | 15420af  |
| 0600 0700         | USA, Amer Forces Network/AFRTS       | 4319usb  |
|                   | 5446usb                              | 5765usb  |
|                   |                                      | 7811usb  |
|                   |                                      | 12133usb |
|                   |                                      | 12759usb |
|                   |                                      | 13362usb |
| 0600 0700         | USA, BBG/Voice of America            | 6080af   |
|                   | 12025af                              | 15580af  |
| 0600 0700         | USA, FBN/WTJC Newport NC             | 9370na   |
| 0600 0700         | USA, Overcomer Ministry              | 15750af  |
| 0600 0700         | USA, WBCQ Monticello ME9330am        |          |
| 0600 0700         | USA, WEWN/EWTN Irondale AL           | 11520af  |
| 0600 0700         | USA, WHRI Cypress Creek SC           | 5920am   |
|                   | 7385na                               | 11910va  |
| 0600 0700         | USA, WTTW Lebanon TN                 | 5755va   |
| 0600 0700         | USA, WWCN Nashville TN               | 3215eu   |
|                   | 5890af                               | 5935af   |
| 0600 0700         | USA, WWRB Manchester TN              | 3185na   |
| 0600 0700         | Zambia, Christian Voice              | 6065af   |
| 0600 0700         | Zambia, CVC Intl/1 Africa            | 13590af  |
| 0617 0630 Sun     | Nepal, R Nepal                       | 5005do   |
| 0630 0645         | India, AIR/Guwahati                  | 4940do   |
| 0630 0645         | India, AIR/Hyderabad                 | 7420do   |
| 0630 0645         | India, AIR/Mumbai                    | 4840do   |
| 0630 0645         | India, AIR/Thiruvananthapuram        | 5010do   |
| 0630 0700         | Germany, Deutsche Welle              | 13780af  |
| 0630 0700         | Vatican City State, Vatican R11625af | 13765af  |
|                   | 15570af                              |          |
| 0645 0700 mtwhf   | Israel, Kol Israel                   | 9955na   |
| 0651 0700         | New Zealand, R New Zealand Intl      | 11725pa  |
| 0651 0700 DRM     | New Zealand, R New Zealand Intl      | 9890pa   |

**0700 UTC - 3AM EDT / 2AM CDT / 12AM PDT**

|               |                                 |         |
|---------------|---------------------------------|---------|
| 0700 0730     | Myanmar, Myanmar R/Yangon       | 9731do  |
| 0700 0750     | Austria, TWR Europe             | 6105eu  |
| 0700 0750     | Germany, TWR Europe             | 6105eu  |
| 0700 0758     | New Zealand, R New Zealand Intl | 11725pa |
| 0700 0758 DRM | New Zealand, R New Zealand Intl | 9890pa  |
| 0700 0800     | Anguilla, University Network    | 6090na  |
| 0700 0800     | Australia, ABC NT Alice Springs | 4835do  |
| 0700 0800     | Australia, ABC NT Katherine     | 5025do  |
| 0700 0800     | Australia, ABC NT Tennant Creek | 4910do  |
| 0700 0800     | Australia, ABC/R Australia      | 7410pa  |
|               | 9710pa                          | 11945pa |
|               |                                 | 13630pa |
|               |                                 | 15240pa |
| 0700 0800     | Bahrain, R Bahrain              | 6010me  |



|           |         |                                  |          |          |
|-----------|---------|----------------------------------|----------|----------|
| 0700 0800 | m/DRM   | Belgium, TDP Radio               | 6015eu   |          |
| 0700 0800 |         | Canada, CFRX Toronto ON          | 6070na   |          |
| 0700 0800 |         | Canada, CFVP Calgary AB          | 6030na   |          |
| 0700 0800 |         | Canada, CKZN St Johns NF         | 6160na   |          |
| 0700 0800 |         | Canada, CKZU Vancouver BC        | 6160na   |          |
| 0700 0800 |         | China, China R International     | 11895as  |          |
|           |         | 13660as                          | 13710eu  | 15125va  |
|           |         | 15465as                          | 17490eu  | 17540as  |
| 0700 0800 | mtwhfa  | Ecuador, HCJB/LV de los Andes    | 3995eu   |          |
| 0700 0800 |         | Eq Guinea, Pan Am BC/R Africa    | 15190af  |          |
| 0700 0800 |         | Malaysia, RTM Kajang/Traxx FM    | 7295do   |          |
| 0700 0800 |         | Micronesia, V6MP/Cross R/Pohnpei | 4755 as  |          |
| 0700 0800 |         | Papua New Guinea, R Fly          | 3915do   |          |
| 0700 0800 |         | Russia, Voice of Russia          | 21800va  |          |
| 0700 0800 | DRM     | Russia, Voice of Russia          | 11830eu  |          |
| 0700 0800 |         | South Africa, Channel Africa     | 9625af   |          |
| 0700 0800 |         | Swaziland, TWR Africa            | 6120af   | 9500af   |
| 0700 0800 | Sat/Sun | Swaziland, TWR Africa            | 3200af   |          |
| 0700 0800 |         | UK, BBC World Service            | 6190af   | 11760me  |
|           |         | 11770af                          | 12095af  | 15310af  |
|           |         | 15575me                          | 17640af  | 17790as  |
| 0700 0800 | DRM     | UK, BBC World Service            | 5875eu   | 7355eu   |
| 0700 0800 |         | USA, Amer Forces Network/AFRTS   | 4319usb  |          |
|           |         | 5446usb                          | 5765usb  | 7811usb  |
|           |         | 12759usb                         | 13362usb | 12133usb |
| 0700 0800 |         | USA, FBN/WTJC Newport NC         | 9370na   |          |
| 0700 0800 |         | USA, WBCQ Monticello ME          | 9330am   |          |
| 0700 0800 |         | USA, WEWN/EWTN Irondale AL       | 11520af  |          |
| 0700 0800 |         | USA, WHRI Cypress Creek SC       | 5920am   |          |
|           |         | 7385na                           |          |          |
| 0700 0800 |         | USA, WTWV Lebanon TN             | 5755va   |          |
| 0700 0800 |         | USA, WWCR Nashville TN           | 3215eu   | 4840na   |
|           |         | 5890af                           | 5935af   |          |
| 0700 0800 |         | USA, WWRB Manchester TN          | 3185na   |          |
| 0700 0800 |         | Zambia, Christian Voice          | 6065af   |          |
| 0700 0800 |         | Zambia, CVC Intl/1 Africa        | 13590af  |          |
| 0730 0745 |         | India, AIR/Aizawl                | 5050do   | 7295do   |
| 0730 0745 |         | India, AIR/Chennai               | 4920do   | 7380do   |
| 0730 0745 |         | India, AIR/Guwahati              | 4940do   | 7280do   |
| 0730 0745 |         | India, AIR/Imphal                | 4775do   | 7335do   |
| 0730 0745 |         | India, AIR/Jaipur                | 4910do   | 7325do   |
| 0730 0745 |         | India, AIR/Kolkata               | 4820do   | 7210do   |
| 0730 0745 |         | India, AIR/Shimla                | 4965do   | 6020do   |
| 0730 0800 |         | Australia, HCJB Global Australia | 11750as  |          |
| 0759 0800 |         | New Zealand, R New Zealand Intl  | 6170pa   |          |
| 0759 0800 | DRM     | New Zealand, R New Zealand Intl  | 7440pa   |          |

**0800 UTC - 4AM EDT / 3AM CDT / 1AM PDT**

|           |        |                                  |         |         |
|-----------|--------|----------------------------------|---------|---------|
| 0800 0830 |        | Australia, ABC NT Alice Springs  | 4835do  |         |
| 0800 0830 |        | Australia, ABC NT Katherine      | 5025do  |         |
| 0800 0830 |        | Australia, ABC NT Tennant Creek  | 4910do  |         |
| 0800 0830 |        | Australia, HCJB Global Australia | 11750as |         |
| 0800 0830 | Sun    | Canada, Bible Voice Broadcasting | 5945eu  |         |
| 0800 0830 |        | France, R France International   | 9955na  |         |
| 0800 0845 | Sat    | Canada, Bible Voice Broadcasting | 5945eu  |         |
| 0800 0900 |        | Anguilla, University Network     | 6090na  |         |
| 0800 0900 |        | Australia, ABC/R Australia       | 5995pa  | 7410pa  |
|           |        | 9475pa                           | 9580pa  | 9710pa  |
|           |        | 15240pa                          |         | 11945pa |
| 0800 0900 |        | Bahrain, R Bahrain               | 6010me  |         |
| 0800 0900 | t/DRM  | Belgium, TDP Radio               | 6015eu  |         |
| 0800 0900 |        | Canada, CFRX Toronto ON          | 6070na  |         |
| 0800 0900 |        | Canada, CFVP Calgary AB          | 6030na  |         |
| 0800 0900 |        | Canada, CKZN St Johns NF         | 6160na  |         |
| 0800 0900 |        | Canada, CKZU Vancouver BC        | 6160na  |         |
| 0800 0900 |        | China, China R International     | 11620as |         |
|           |        | 11895as                          | 13710eu | 15350as |
|           |        | 15625va                          | 17490eu | 17540as |
| 0800 0900 |        | Eq Guinea, Pan Am BC/R Africa    | 15190af |         |
| 0800 0900 | Sat    | Italy, IRRS SW                   | 9510va  |         |
| 0800 0900 |        | Malaysia, RTM Kajang/Traxx FM    | 7295do  |         |
| 0800 0900 |        | Micronesia, V6MP/Cross R/Pohnpei | 4755 as |         |
| 0800 0900 |        | New Zealand, R New Zealand Intl  | 6170pa  |         |
| 0800 0900 | DRM    | New Zealand, R New Zealand Intl  | 7440pa  |         |
| 0800 0900 | mtwhfs | Palau, T8WH/World Harvest R      | 9930as  |         |
| 0800 0900 |        | Palau, T8WH/World Harvest R      | 17650as |         |
| 0800 0900 |        | Papua New Guinea, R Fly          | 3915do  |         |
| 0800 0900 |        | Russia, Voice of Russia          | 21800va |         |

|           |        |                                 |          |          |
|-----------|--------|---------------------------------|----------|----------|
| 0800 0900 | DRM    | Russia, Voice of Russia         | 9850eu   | 11830eu  |
| 0800 0900 |        | South Africa, Channel Africa    | 9625af   |          |
| 0800 0900 | Sun    | South Africa, R Mirror Intl     | 7205af   | 17570af  |
| 0800 0900 |        | South Korea, KBS World R        | 9570as   |          |
| 0800 0900 |        | UK, BBC World Service           | 6190af   | 11760me  |
|           |        | 12095af                         | 15310as  | 15400af  |
|           |        | 17640af                         | 17790as  | 17830af  |
| 0800 0900 |        | USA, Amer Forces Network/AFRTS  | 4319usb  |          |
|           |        | 5446usb                         | 5765usb  | 7811usb  |
|           |        | 12759usb                        | 13362usb | 12133usb |
| 0800 0900 |        | USA, FBN/WTJC Newport NC        | 9370na   |          |
| 0800 0900 |        | USA, WBCQ Monticello ME         | 9330am   |          |
| 0800 0900 |        | USA, WEWN/EWTN Irondale AL      | 11520af  |          |
| 0800 0900 |        | USA, WHRI Cypress Creek SC      | 5920am   |          |
|           |        | 7385na                          |          |          |
| 0800 0900 |        | USA, WTWV Lebanon TN            | 5755va   |          |
| 0800 0900 |        | USA, WWCR Nashville TN          | 3215eu   | 4840na   |
|           |        | 5890af                          | 5935af   |          |
| 0800 0900 |        | USA, WWRB Manchester TN         | 3185na   |          |
| 0800 0900 |        | Zambia, Christian Voice         | 6065af   |          |
| 0800 0900 |        | Zambia, CVC Intl/1 Africa       | 13590af  |          |
| 0815 0827 |        | Nepal, R Nepal                  | 5005do   |          |
| 0820 0900 | mtwhfa | Guam, KTWR/TWR Asia             | 15170as  |          |
| 0830 0845 |        | India, AIR/Aizawl               | 5050do   | 7295do   |
| 0830 0845 |        | India, AIR/Chennai              | 4920do   | 7380do   |
| 0830 0845 |        | India, AIR/Hyderabad            | 7420do   |          |
| 0830 0845 |        | India, AIR/Imphal               | 4775do   | 7335do   |
| 0830 0845 |        | India, AIR/Kolkata              | 4820do   | 7210do   |
| 0830 0845 |        | India, AIR/Shillong             | 4970do   | 7315do   |
| 0830 0845 |        | India, AIR/Thiruvananthapuram   | 5010do   |          |
| 0830 0900 |        | Australia, ABC NT Alice Springs | 2310do   |          |
| 0830 0900 |        | Australia, ABC NT Katherine     | 2485do   |          |
| 0830 0900 |        | Australia, ABC NT Tennant Creek | 2325do   |          |
| 0830 0900 | mtwhfa | Guam, KTWR/TWR Asia             | 11840pa  |          |
| 0830 0900 |        | India, AIR/Itanagar             | 4990do   |          |

**0900 UTC - 5AM EDT / 4AM CDT / 2AM PDT**

|           |         |                                  |          |          |
|-----------|---------|----------------------------------|----------|----------|
| 0900 0910 | mtwhfa  | Guam, KTWR/TWR Asia              | 11840as  |          |
| 0900 0930 | mtwhfa  | USA, WRMI/R Prague relay         | 9955ca   |          |
| 0900 1000 |         | Anguilla, University Network     | 6090na   |          |
| 0900 1000 |         | Australia, ABC NT Alice Springs  | 2310do   |          |
| 0900 1000 |         | Australia, ABC NT Katherine      | 2485do   |          |
| 0900 1000 |         | Australia, ABC NT Tennant Creek  | 2325do   |          |
| 0900 1000 |         | Australia, ABC/R Australia       | 6020pa   | 9580pa   |
|           |         | 11945pa                          |          |          |
| 0900 1000 |         | Bahrain, R Bahrain               | 6010me   |          |
| 0900 1000 | w/DRM   | Belgium, TDP Radio               | 6015eu   |          |
| 0900 1000 |         | Canada, CFRX Toronto ON          | 6070na   |          |
| 0900 1000 |         | Canada, CFVP Calgary AB          | 6030na   |          |
| 0900 1000 |         | Canada, CKZN St Johns NF         | 6160na   |          |
| 0900 1000 |         | Canada, CKZU Vancouver BC        | 6160na   |          |
| 0900 1000 |         | China, China R International     | 11620as  |          |
|           |         | 13790pa                          | 15210as  | 15270eu  |
|           |         | 17490eu                          | 17570eu  | 17750as  |
| 0900 1000 | Sat/Sun | Germany, Mighty KBC Radio        | 6095eu   |          |
| 0900 1000 |         | Malaysia, RTM Kajang/Traxx FM    | 7295do   |          |
| 0900 1000 |         | Micronesia, V6MP/Cross R/Pohnpei | 4755 as  |          |
| 0900 1000 | 3rd Sun | Netherlands, XVRB Radio          | 6045eu   |          |
| 0900 1000 | DRM     | New Zealand, R New Zealand Intl  | 7440pa   |          |
| 0900 1000 |         | New Zealand, R New Zealand Intl  | 6170pa   |          |
| 0900 1000 |         | Nigeria, Voice of Nigeria        | 9690af   |          |
| 0900 1000 |         | Palau, T8WH/World Harvest R      | 9930as   |          |
| 0900 1000 |         | Papua New Guinea, R Fly          | 3915do   |          |
| 0900 1000 |         | Russia, Voice of Russia          | 9560as   | 15170as  |
|           |         | 21800va                          |          |          |
| 0900 1000 | DRM     | Russia, Voice of Russia          | 9850eu   | 11830eu  |
| 0900 1000 |         | South Africa, Channel Africa     | 9625af   |          |
| 0900 1000 |         | UK, BBC World Service            | 6190af   | 6195as   |
|           |         | 9740as                           | 11760me  | 12095af  |
|           |         | 15310as                          | 15575me  | 17640af  |
|           |         | 17790as                          | 17830af  | 21470af  |
| 0900 1000 |         | USA, Amer Forces Network/AFRTS   | 4319usb  |          |
|           |         | 5446usb                          | 5765usb  | 7811usb  |
|           |         | 12759usb                         | 13362usb | 12133usb |
| 0900 1000 |         | USA, FBN/WTJC Newport NC         | 9370na   |          |
| 0900 1000 |         | USA, WBCQ Monticello ME          | 9330am   |          |
| 0900 1000 |         | USA, WEWN/EWTN Irondale AL       | 11520as  |          |

|               |                                      |                 |
|---------------|--------------------------------------|-----------------|
| 0900 1000     | USA, WHRI Cypress Creek SC           | 11565pa         |
| 0900 1000     | USA, WHRI Cypress Creek SC<br>7385na | 7315am          |
| 0900 1000     | USA, WTTW Lebanon TN                 | 5755va          |
| 0900 1000     | USA, WWCR Nashville TN               | 4840eu 5890af   |
|               | 5935af 6875af                        |                 |
| 0900 1000     | USA, WWRB Manchester TN              | 3185na          |
| 0900 1000     | USA, WYFR/Family R Worldwide         | 9465as          |
| 0900 1000     | Zambia, Christian Voice              | 6065af          |
| 0900 1000     | Zambia, CVC Intl/1 Africa            | 13590af         |
| 0905 0910     | Pakistan, PBC/R Pakistan             | 15725as 17720as |
| 0930 1000 Sun | Italy, IRRS SW                       | 9510va          |

**1000 UTC - 6AM EDT / 5AM CDT / 3AM PDT**

|                   |                                  |                 |
|-------------------|----------------------------------|-----------------|
| 1000 1030         | Japan, R Japan NHK World         | 9605as          |
|                   | 9625pa 9695as                    |                 |
| 1000 1030         | Vietnam, VO Vietnam/Overseas Svc | 9840as          |
|                   | 12020as                          |                 |
| 1000 1057         | North Korea, Voice of Korea      | 3560ca          |
|                   | 11710sa 15180as 11735as          | 13650as         |
| 1000 1058         | New Zealand, R New Zealand Intl  | 6170pa          |
| 1000 1100         | Anguilla, University Network     | 11775na         |
| 1000 1100         | Australia, ABC NT Alice Springs  | 2310do          |
| 1000 1100         | Australia, ABC NT Katherine      | 2485do          |
| 1000 1100         | Australia, ABC NT Tennant Creek  | 2325do          |
| 1000 1100         | Australia, ABC/R Australia       | 6020pa 9580pa   |
|                   | 11945pa                          |                 |
| 1000 1100         | Bahrain, R Bahrain               | 6010me          |
| 1000 1100 h/DRM   | Belgium, TDP Radio               | 6015eu          |
| 1000 1100         | Canada, CFRX Toronto ON          | 6070na          |
| 1000 1100         | Canada, CFVP Calgary AB          | 6030na          |
| 1000 1100         | Canada, CKZN St Johns NF         | 6160na          |
| 1000 1100         | Canada, CKZU Vancouver BC        | 6160na          |
| 1000 1100         | China, China R International     | 6040na          |
|                   | 11610as 11635as 13620as 13690as  |                 |
|                   | 13720as 13790pa 15190as 15210as  |                 |
|                   | 15350as 17490eu                  |                 |
| 1000 1100 Sat/Sun | Germany, Mighty KBC Radio        | 6095eu          |
| 1000 1100         | India/AIR/External Service       | 7270as 13695pa  |
|                   | 15020as 15410as 17510pa 17800as  |                 |
|                   | 17895pa                          |                 |
| 1000 1100         | Indonesia, VO Indonesia          | 9526va          |
| 1000 1100         | Malaysia, RTM Kajang/Traxx FM    | 7295do          |
| 1000 1100         | Micronesia, V6MP/Cross R/Pohnpei | 4755as          |
| 1000 1100 DRM     | New Zealand, R New Zealand Intl  | 7440pa          |
| 1000 1100         | Nigeria, Voice of Nigeria        | 9690af          |
| 1000 1100         | Palau, T8WH/World Harvest R      | 17650as         |
| 1000 1100         | Russia, Voice of Russia          | 9560as 11500as  |
|                   | 15170as                          |                 |
| 1000 1100         | Saudi Arabia, BSKSA/External Svc | 15250as         |
| 1000 1100         | South Africa, Channel Africa     | 9625af          |
| 1000 1100         | UK, BBC World Service            | 6190af 6195as   |
|                   | 9740as 11760me 12095af 15285as   |                 |
|                   | 15310as 15575me 17640af 17760as  |                 |
|                   | 17790as 21470af 21660as          |                 |
| 1000 1100 Sat/Sun | UK, BBC World Service            | 15400af 17830af |
| 1000 1100         | USA, Amer Forces Network/AFRTS   | 4319usb         |
|                   | 5446usb 5765usb 7811usb 12133usb |                 |
|                   | 12759usb 13362usb                |                 |
| 1000 1100         | USA, FBN/WTJC Newport NC         | 9370na          |
| 1000 1100         | USA, KNLS Anchor Point AK        | 9655as          |
| 1000 1100         | USA, WBCQ Monticello ME          | 9330am          |
| 1000 1100         | USA, WEWN/EWTN Irontdale AL      | 11520as         |
| 1000 1100         | USA, WHRI Cypress Creek SC       | 7315am          |
|                   | 7385na                           |                 |
| 1000 1100         | USA, WTTW Lebanon TN             | 5755va          |
| 1000 1100         | USA, WWCR Nashville TN           | 4840na 5890af   |
|                   | 5935af 6875af                    |                 |
| 1000 1100         | USA, WWRB Manchester TN          | 3185na          |
| 1000 1100         | USA, WYFR/Family R Worldwide     | 9465as          |
| 1000 1100         | Zambia, Christian Voice          | 6065af          |
| 1000 1100         | Zambia, CVC Intl/1 Africa        | 13590af         |
| 1030 1100         | Iran, VO Islamic Rep of Iran     | 21590va 21640va |
| 1030 1100         | Mongolia, Voice of Mongolia      | 12085as         |
| 1030 1100         | USA, WINB Red Lion PA            | 9265am          |
| 1059 1100         | New Zealand, R New Zealand Intl  | 9655pa          |

**1100 UTC - 7AM EDT / 6AM CDT / 4AM PDT**

|                   |                                  |                 |
|-------------------|----------------------------------|-----------------|
| 1100 1104         | Pakistan, PBC/R Pakistan         | 15725as 17720as |
| 1100 1127         | Iran, VO Islamic Rep of Iran     | 21590va 21640va |
| 1100 1130 Sat/DRM | South Korea, KBS World R         | 9760eu          |
| 1100 1130         | UK, BBC World Service            | 15400af         |
| 1100 1130         | Vietnam, VO Vietnam/Overseas Svc | 7285as          |
| 1100 1156         | Romania, R Romania Intl          | 15210eu 15430eu |
|                   | 17510af 17670af                  |                 |
| 1100 1158 DRM     | New Zealand, R New Zealand Intl  | 7440pa          |
| 1100 1200         | Anguilla, University Network     | 11775na         |
| 1100 1200         | Australia, ABC NT Alice Springs  | 2310do          |
| 1100 1200         | Australia, ABC NT Katherine      | 2485do          |
| 1100 1200         | Australia, ABC NT Tennant Creek  | 2325do          |
| 1100 1200         | Australia, ABC/R Australia       | 6020pa 6080pa   |
|                   | 6140as 9475as 9580pa             | 11945va         |
| 1100 1200 DRM     | Australia, ABC/R Australia       | 12080pa         |
| 1100 1200         | Bahrain, R Bahrain               | 6010me          |
| 1100 1200 f/DRM   | Belgium, TDP Radio               | 6015eu          |
| 1100 1200         | Canada, CFRX Toronto ON          | 6070na          |
| 1100 1200         | Canada, CFVP Calgary AB          | 6030na          |
| 1100 1200         | Canada, CKZN St Johns NF         | 6160na          |
| 1100 1200         | Canada, CKZU Vancouver BC        | 6160na          |
| 1100 1200         | China, China R International     | 5955as          |
|                   | 6040na 11650as 11660as 11750na   |                 |
|                   | 11795as 13590as 13645as 13650eu  |                 |
|                   | 13720as 17490eu                  |                 |
| 1100 1200 Sat/Sun | Germany, Mighty KBC Radio        | 6095eu          |
| 1100 1200         | Malaysia, RTM Kajang/Traxx FM    | 7295do          |
| 1100 1200         | New Zealand, R New Zealand Intl  | 9655pa          |
| 1100 1200         | Nigeria, Voice of Nigeria        | 9690af          |
| 1100 1200 DRM     | Russia, Voice of Russia          | 12030as         |
| 1100 1200         | Russia, Voice of Russia          | 9560as 11500as  |
|                   | 12065as                          |                 |
| 1100 1200         | Saudi Arabia, BSKSA/External Svc | 15250as         |
| 1100 1200         | South Africa, Channel Africa     | 9625af          |
| 1100 1200         | Taiwan, R Taiwan Intl            | 7445as 9465as   |
| 1100 1200         | UK, BBC World Service            | 6190af 6195as   |
|                   | 9740as 11760me 12095af 15285as   |                 |
|                   | 15310as 15575me 17640af 17790as  |                 |
|                   | 17830af 21470af                  |                 |
| 1100 1200         | USA, Amer Forces Network/AFRTS   | 4319usb         |
|                   | 5446usb 5765usb 7811usb 12133usb |                 |
|                   | 12759usb 13362usb                |                 |
| 1100 1200         | USA, FBN/WTJC Newport NC         | 9370na          |
| 1100 1200         | USA, WBCQ Monticello ME          | 9330am          |
| 1100 1200         | USA, WEWN/EWTN Irontdale AL      | 11520as         |
| 1100 1200         | USA, WHRI Cypress Creek SC       | 7315am          |
|                   | 7385na                           |                 |
| 1100 1200         | USA, WINB Red Lion PA            | 9265am          |
| 1100 1200         | USA, WTTW Lebanon TN             | 5755va          |
| 1100 1200         | USA, WWCR Nashville TN           | 4840na 5890af   |
|                   | 5935af 6875af                    |                 |
| 1100 1200         | USA, WWRB Manchester TN          | 3185na          |
| 1100 1200         | Zambia, Christian Voice          | 6065af          |
| 1100 1200         | Zambia, CVC Intl/1 Africa        | 13590af         |
| 1130 1145 f       | Palau, T8WH/World Harvest R      | 15525as         |
| 1130 1200 f       | Vatican City State, Vatican R    | 15595me 17590me |
| 1130 1200         | Vietnam, VO Vietnam/Overseas Svc | 9840as          |
|                   | 12020as                          |                 |
| 1135 1145         | India, AIR/Aizawl                | 5050do 7295do   |
| 1135 1145         | India, AIR/Shillong              | 4970do          |

**1200 UTC - 8AM EDT / 7AM CDT / 5AM PDT**

|           |                                  |               |
|-----------|----------------------------------|---------------|
| 1200 1225 | Saudi Arabia, BSKSA/External Svc | 15250as       |
| 1200 1230 | Germany, AWR Europe              | 17535as       |
| 1200 1230 | Indonesia, AWR Asia/Pacific      | 17535as       |
| 1200 1230 | Japan, R Japan NHK World         | 6120na        |
|           | 9695as                           |               |
| 1200 1259 | New Zealand, R New Zealand Intl  | 9655pa        |
| 1200 1300 | Anguilla, University Network     | 11775na       |
| 1200 1300 | Australia, ABC NT Alice Springs  | 2310do        |
| 1200 1300 | Australia, ABC NT Katherine      | 2485do        |
| 1200 1300 | Australia, ABC NT Tennant Creek  | 2325do        |
| 1200 1300 | Australia, ABC/R Australia       | 5995pa 6020pa |
|           | 6080pa 6140as 9475as 9580pa      |               |
|           | 11945as 12080pa                  |               |
| 1200 1300 | Bahrain, R Bahrain               | 6010me        |



|                   |   |          |          |
|-------------------|---|----------|----------|
| 1200 1300 Sat/DRM | Belgium, TDP Radio                      | 6015eu   |          |
| 1200 1300         | Canada, CFRX Toronto ON                 | 6070na   |          |
| 1200 1300         | Canada, CFVP Calgary AB                 | 6030na   |          |
| 1200 1300         | Canada, CKZN St Johns NF                | 6160na   |          |
| 1200 1300         | Canada, CKZU Vancouver BC               | 6160na   |          |
| 1200 1300         | China, China R International            | 5955as   |          |
|                   | 9460as                                  | 9645as   | 9660as   |
|                   | 9760pa                                  | 11650as  | 11660as  |
|                   | 11760pa                                 | 11980as  | 13645as  |
|                   | 13790eu                                 | 17490eu  | 13650eu  |
| 1200 1300         | Ethiopia, R Ethiopia/Natl Pgm           | 9705do   |          |
| 1200 1300 Sat/Sun | Germany, Mighty KBC Radio               | 6095eu   |          |
| 1200 1300         | Malaysia, RTM Kajang/Traxx FM           | 7295do   |          |
| 1200 1300         | Nigeria, Voice of Nigeria               | 9690af   |          |
| 1200 1300         | Palau, T8WH/World Harvest R             | 9930as   |          |
| 1200 1300 DRM     | Russia, Voice of Russia                 | 9850eu   | 9445as   |
|                   | 12030as                                 |          |          |
| 1200 1300         | Russia, Voice of Russia                 | 9560as   | 11500as  |
| 1200 1300         | South Korea, KBS World R                | 9650na   |          |
| 1200 1300         | UK, BBC World Service                   | 5875as   | 6190af   |
|                   | 6195as                                  | 9740as   | 11750as  |
|                   | 15310as                                 | 15575me  | 17790as  |
|                   | 21470af                                 | 17830af  |          |
| 1200 1300         | USA, Amer Forces Network/AFRTS          | 4319usb  |          |
|                   | 5446usb                                 | 5765usb  | 7811usb  |
|                   | 12759usb                                | 13362usb | 12133usb |
| 1200 1300         | USA, BBG/Voice of America               | 7575as   |          |
|                   | 9510as                                  | 12075as  | 12150as  |
| 1200 1300         | USA, FBN/WTJC Newport NC                | 9370na   |          |
| 1200 1300         | USA, KNLS Anchor Point AK               | 7355as   |          |
| 1200 1300         | USA, WBCQ Monticello ME                 | 9330am   |          |
| 1200 1300         | USA, WEWN/EWTN Irondale AL              | 11520as  |          |
| 1200 1300         | USA, WHRI Cypress Creek SC              | 9795am   |          |
|                   | 9840na                                  |          |          |
| 1200 1300         | USA, WINB Red Lion PA                   | 9265am   |          |
| 1200 1300         | USA, WTWW Lebanon TN                    | 5755va   |          |
| 1200 1300         | USA, WWCR Nashville TN                  | 7490na   | 9980af   |
|                   | 13845af                                 | 15825eu  |          |
| 1200 1300         | USA, WWRB Manchester TN                 | 9385na   |          |
| 1200 1300         | Zambia, Christian Voice                 | 6065af   |          |
| 1200 1300         | Zambia, CVC Intl/1 Africa               | 13590af  |          |
| 1215 1300         | Egypt, R Cairo                          | 17870as  |          |
| 1225 1245         | India, AIR/Imphal                       | 4775do   |          |
| 1230 1245         | India, AIR/Aizawl                       | 5050do   | 7295do   |
| 1230 1245         | India, AIR/Chennai                      | 4920do   |          |
| 1230 1245         | India, AIR/Hyderabad                    | 4800do   |          |
| 1230 1245         | India, AIR/Imphal                       | 4800do   |          |
| 1230 1245         | India, AIR/Jeyapore                     | 5040do   |          |
| 1230 1245         | India, AIR/Kuresong                     | 4895do   |          |
| 1230 1245         | India, AIR/Port Blair/Andaman & Nicobar | 4760do   |          |
| 1230 1245         | India, AIR/Shillong                     | 4970do   |          |
| 1230 1245         | India, AIR/Thiruvananthapuram           | 5010do   |          |
| 1230 1245         | India, AIR/R Kashmir                    | 4950do   |          |
| 1230 1300         | Australia, HCBJ Global Australia        | 15400as  |          |
| 1230 1300         | Thailand, R Thailand World Svc          | 9890va   |          |
| 1230 1300         | Turkey, Voice of Turkey                 | 15450va  |          |
| 1230 1300         | Vietnam, VO Vietnam/Overseas Svc        | 9840as   |          |
|                   | 12020as                                 |          |          |

**1300 UTC - 9AM EDT / 8AM CDT / 6AM PDT**

|                   |                                 |         |         |
|-------------------|---------------------------------|---------|---------|
| 1300 1325         | Turkey, Voice of Turkey         | 15450va |         |
| 1300 1330         | Egypt, R Cairo                  | 17870as |         |
| 1300 1330         | Japan, R Japan NHK World        | 15735as |         |
| 1300 1330         | Serbia, International R Serbia  | 9635eu  |         |
| 1300 1357         | North Korea, Voice of Korea     | 9335na  |         |
|                   | 11710na                         | 13760eu | 15245eu |
| 1300 1400         | Anguilla, University Network    | 11775na |         |
| 1300 1400         | Australia, ABC NT Alice Springs | 2310do  |         |
| 1300 1400         | Australia, ABC NT Katherine     | 2485do  |         |
| 1300 1400         | Australia, ABC/R Australia      | 6020pa  | 9580pa  |
|                   | 11945pa                         |         |         |
| 1300 1400         | Bahrain, R Bahrain              | 6010me  |         |
| 1300 1400 Sun/DRM | Belgium, TDP Radio              | 6015na  |         |
| 1300 1400         | Canada, CFRX Toronto ON         | 6070na  |         |
| 1300 1400         | Canada, CFVP Calgary AB         | 6030na  |         |
| 1300 1400         | Canada, CKZN St Johns NF        | 6160na  |         |
| 1300 1400         | Canada, CKZU Vancouver BC       | 6160na  |         |

|                   |                                      |          |          |
|-------------------|--------------------------------------|----------|----------|
| 1300 1400         | China, China R International         | 5995as   |          |
|                   | 9570na                               | 9650na   | 9730as   |
|                   | 9765va                               | 9870as   | 11660as  |
|                   | 13610eu                              | 13755as  | 13790eu  |
| 1300 1400 Sat/Sun | Germany, Mighty KBC Radio            | 6095eu   |          |
| 1300 1400         | Indonesia, VO Indonesia              | 9526va   |          |
| 1300 1400         | Italy, IRRS SW                       | 15190va  |          |
| 1300 1400         | Malaysia, RTM Kajang/Traxx FM        | 7295do   |          |
| 1300 1400         | New Zealand, R New Zealand Intl      | 6170pa   |          |
| 1300 1400         | Nigeria, Voice of Nigeria            | 9690af   |          |
| 1300 1400         | Palau, T8WH/World Harvest R          | 9930as   |          |
| 1300 1400 DRM     | Russia, Voice of Russia              | 9850eu   | 12095as  |
| 1300 1400         | Russia, Voice of Russia              | 12065as  |          |
| 1300 1400         | South Korea, KBS World R             | 9570as   |          |
| 1300 1400         | Tajikistan, VO Tajik                 | 7245va   |          |
| 1300 1400         | UK, BBC World Service                | 5875as   | 6190af   |
|                   | 6195as                               | 9740as   | 11760me  |
|                   | 15420af                              | 15575me  | 17640af  |
|                   | 17830af                              |          | 17790as  |
| 1300 1400         | USA, Amer Forces Network/AFRTS       | 4319usb  |          |
|                   | 5446usb                              | 5765usb  | 7811usb  |
|                   | 12759usb                             | 13362usb | 12133usb |
| 1300 1400         | USA, BBG/Voice of America            | 7575as   |          |
| 1300 1400 Sat/Sun | USA, BBG/Voice of America            | 7575as   |          |
|                   | 9510as                               | 9610as   | 12150as  |
| 1300 1400         | USA, FBN/WTJC Newport NC             | 9370na   |          |
| 1300 1400         | USA, KJES Vado NM                    | 11715na  |          |
| 1300 1400         | USA, WBCQ Monticello ME              | 9330am   |          |
| 1300 1400         | USA, WEWN/EWTN Irondale AL           | 15615as  |          |
| 1300 1400 Sat/Sun | USA, WHRI Cypress Creek SC           | 9795na   |          |
|                   | 9840am                               |          |          |
| 1300 1400         | USA, WINB Red Lion PA                | 13570am  |          |
| 1300 1400         | USA, WTWW Lebanon TN                 | 9479va   |          |
| 1300 1400         | USA, WWCR Nashville TN               | 7490af   | 9980af   |
|                   | 13845eu                              | 15825eu  |          |
| 1300 1400         | USA, WWRB Manchester TN              | 9385na   |          |
| 1300 1400         | USA, WYFR/Family R Worldwide         | 11540as  |          |
| 1300 1400         | Zambia, Christian Voice              | 6065af   |          |
| 1300 1400         | Zambia, CVC Intl/1 Africa            | 13590af  |          |
| 1330 1400 f       | Clandestine, JSR/Shiokaze/Sea Breeze | 5985as   |          |
| 1330 1400         | India, AIR/External Service          | 9690as   | 11620as  |
|                   | 13710as                              |          |          |
| 1330 1400         | Vietnam, VO Vietnam/Overseas Svc     | 9840as   |          |
|                   | 12020as                              |          |          |

**1400 UTC - 10AM EDT / 9AM CDT / 7AM PDT**

|                   |                                      |         |         |
|-------------------|--------------------------------------|---------|---------|
| 1400 1430 f       | Clandestine, JSR/Shiokaze/Sea Breeze | 5985as  |         |
| 1400 1430         | Japan, R Japan NHK World             | 11705as |         |
|                   | 15735as                              |         |         |
| 1400 1430         | Thailand, R Thailand World Svc       | 9395va  |         |
| 1400 1430 Sun     | USA, Pan Amer Broadcasting           | 15205as |         |
| 1400 1500         | Anguilla, University Network         | 11775na |         |
| 1400 1500         | Australia, ABC NT Alice Springs      | 2310do  |         |
| 1400 1500         | Australia, ABC NT Katherine          | 2485do  |         |
| 1400 1500         | Australia, ABC NT Tennant Creek      | 2325do  |         |
| 1400 1500         | Australia, ABC/R Australia           | 5995pa  | 9580pa  |
|                   | 11945pa                              |         |         |
| 1400 1500         | Bahrain, R Bahrain                   | 6010me  |         |
| 1400 1500 Sun     | Canada, Bible Voice Broadcasting     | 17495as |         |
| 1400 1500         | Canada, CFRX Toronto ON              | 6070na  |         |
| 1400 1500         | Canada, CFVP Calgary AB              | 6030na  |         |
| 1400 1500         | Canada, CKZN St Johns NF             | 6160na  |         |
| 1400 1500         | Canada, CKZU Vancouver BC            | 6160na  |         |
| 1400 1500         | China, China R International         | 5955as  |         |
|                   | 9765va                               | 9870as  | 11665me |
|                   | 11765as                              | 13710eu | 13740na |
|                   | 17630af                              | 13790eu |         |
| 1400 1500         | Eq Guinea, Pan Am BC/R Africa        | 15190af |         |
| 1400 1500 Sat/Sun | Germany, Mighty KBC Radio            | 6095eu  |         |
| 1400 1500         | India, AIR/External Service          | 9690as  | 11620as |
|                   | 13710as                              |         |         |
| 1400 1500         | Italy, IRRS SW                       | 15190va |         |
| 1400 1500         | Malaysia, RTM Kajang/Traxx FM        | 7295do  |         |
| 1400 1500         | New Zealand, R New Zealand Intl      | 6170pa  |         |
| 1400 1500         | Nigeria, Voice of Nigeria            | 9690af  |         |
| 1400 1500         | Oman, R Sultanate of Oman            | 15140va |         |

|                   |                                  |          |                  |
|-------------------|----------------------------------|----------|------------------|
| 1400 1500 DRM     | Russia, Voice of Russia          | 12095eu  |                  |
| 1400 1500         | Russia, Voice of Russia          | 4975va   | 9560as           |
|                   | 11500as                          | 11840as  |                  |
| 1400 1500         | South Korea, KBS World R         | 9570as   |                  |
| 1400 1500         | UK, BBC World Service            | 5845as   | 5875as           |
|                   | 6190af                           | 6195as   | 9740as 11890as   |
|                   | 12095af                          | 13820me  | 15310as 17640af  |
|                   | 17830af                          | 21470af  |                  |
| 1400 1500         | USA, Amer Forces Network/AFRTS   | 4319usb  |                  |
|                   | 5446usb                          | 5765usb  | 7811usb 12133usb |
|                   | 12759usb                         | 13362usb |                  |
| 1400 1500         | USA, BBG/Voice of America        | 4930af   |                  |
|                   | 6080af                           | 15265af  | 15580af 17530af  |
| 1400 1500 mtwhf   | USA, BBG/Voice of America        | 7540as   |                  |
|                   | 7575as                           | 12150as  |                  |
| 1400 1500         | USA, FBN/WTJC Newport NC         | 9370na   |                  |
| 1400 1500         | USA, Overcomer Ministry          | 9655eu   |                  |
| 1400 1500         | USA, WBCQ Monticello ME          | 9330am   |                  |
| 1400 1500 Sat/Sun | USA, WBCQ Monticello ME          | 15420am  |                  |
| 1400 1500         | USA, WEWN/EWTN Irondale AL       | 15615as  |                  |
| 1400 1500 Sat/Sun | USA, WHRI Cypress Creek SC       | 9795am   |                  |
|                   | 9840am                           | 21670va  |                  |
| 1400 1500         | USA, WJHR Intl Milton FL         | 15550usb |                  |
| 1400 1500         | USA, WTTWW Lebanon TN            | 9479va   |                  |
| 1400 1500         | USA, WWCR Nashville TN           | 7490af   | 9980af           |
|                   | 13845eu                          | 15825eu  |                  |
| 1400 1500         | USA, WWRB Manchester TN          | 9385na   |                  |
| 1400 1500         | USA, WYFR/Family R Worldwide     | 11540as  |                  |
| 1400 1500         | Zambia, Christian Voice          | 6065af   |                  |
| 1400 1500         | Zambia, CVC Intl/1 Africa        | 13590af  |                  |
| 1405 1435 Sat/Sun | Canada, Bible Voice Broadcasting | 15270as  |                  |
| 1415 1427         | Nepal, R Nepal                   | 5005do   |                  |
| 1415 1430 mtwhfa  | USA, Pan Amer Broadcasting       | 15205as  |                  |
| 1420 1440         | India, AIR/Itanagar              | 4990do   |                  |
| 1420 1455         | Swaziland, TWR Africa            | 4760af   |                  |
| 1430 1445         | India, AIR/Aizawl                | 5050do   | 7295do           |
| 1430 1445         | India, AIR/Gangkok               | 4835do   |                  |
| 1430 1445         | India, AIR/Jeyppore              | 5040do   |                  |
| 1430 1445         | India, AIR/Mumbai                | 4840do   | 7240do           |
| 1430 1445 Sun     | USA, Pan Amer Broadcasting       | 15205as  |                  |
| 1430 1500         | Australia, ABC/R Australia       | 9475as   | 11660as          |
| 1430 1500 Sat     | Canada, Bible Voice Broadcasting | 17495as  |                  |
| 1430 1500         | USA, WRMI/R Prague relay         | 9955ca   |                  |
| 1445 1500         | Australia, HCJB Global Australia | 15340as  |                  |
| 1450 1500         | India, AIR/Itanagar              | 4990do   |                  |
| 1450 1500         | India, AIR/Kuresong              | 4895do   |                  |

**1500 UTC - 11AM EDT / 10AM CDT / 8AM PDT**

|                   |                                  |         |                 |
|-------------------|----------------------------------|---------|-----------------|
| 1500 1515 Sun     | Canada, Bible Voice Broadcasting | 13740as |                 |
| 1500 1525 Sun     | China, Haixa zhi Sheng/VO Strait | 4940do  | 9505do          |
| 1500 1525 mhf     | Guam, KTWR/TWR Asia              | 15200as |                 |
| 1500 1530         | Australia, ABC/R Australia       | 11945pa |                 |
| 1500 1530         | Australia, HCJB Global Australia | 15340as |                 |
| 1500 1530         | Vietnam, VO Vietnam/Overseas Svc | 7285as  |                 |
|                   | 9840as                           | 12020as |                 |
| 1500 1535 twas    | Guam, KTWR/TWR Asia              | 15200as |                 |
| 1500 1550         | New Zealand, R New Zealand Intl  | 6170pa  |                 |
| 1500 1557         | North Korea, Voice of Korea      | 9335na  |                 |
|                   | 11710na                          | 13760eu | 15245eu         |
| 1500 1600         | Anguilla, University Network     | 11775na |                 |
| 1500 1600         | Australia, ABC NT Alice Springs  | 2310do  |                 |
| 1500 1600         | Australia, ABC NT Katherine      | 2485do  |                 |
| 1500 1600         | Australia, ABC/R Australia       | 5940as  | 5995pa          |
|                   | 7240pa                           | 9475as  | 11660as         |
| 1500 1600         | Bahrain, R Bahrain               | 6010me  |                 |
| 1500 1600         | Canada, CFRX Toronto ON          | 6070na  |                 |
| 1500 1600         | Canada, CFVP Calgary AB          | 6030na  |                 |
| 1500 1600         | Canada, CKZN St Johns NF         | 6160na  |                 |
| 1500 1600         | Canada, CKZU Vancouver BC        | 6160na  |                 |
| 1500 1600         | China, China R International     | 5955as  |                 |
|                   | 6095me                           | 7325as  | 7395as 9720me   |
|                   | 9800as                           | 9870as  | 11965eu 13640eu |
|                   | 13740na                          | 17630af |                 |
| 1500 1600 Sat     | Clandestine, Sudan R Service     | 17745af |                 |
| 1500 1600         | Eqt Guinea, Pan Am BC/R Africa   | 15190af |                 |
| 1500 1600 Sat/Sun | Germany, Mighty KBC Radio        | 6095eu  |                 |
| 1500 1600 Sat     | Italy, IRRS SW                   | 15700va |                 |

|                   |   |          |                  |
|-------------------|---|----------|------------------|
| 1500 1600         | Malaysia, RTM Kajang/Traxx FM           | 7295do   |                  |
| 1500 1600         | Nigeria, Voice of Nigeria               | 15120af  |                  |
| 1500 1600 DRM     | Russia, Voice of Russia                 | 6070as   | 7370as           |
| 1500 1600         | Russia, Voice of Russia                 | 4975va   | 9560as           |
|                   | 11840as                                 | 15640me  |                  |
| 1500 1600         | South Africa, Channel Africa            | 9625af   |                  |
| 1500 1600         | Uganda, Dunamis Shortwave               | 4750do   |                  |
| 1500 1600         | UK, BBC World Service                   | 5845as   | 5875as           |
|                   | 6190af                                  | 6195as   | 7435af 9410as    |
|                   | 9740as                                  | 11890as  | 12095af 13820me  |
|                   | 15310as                                 | 15400af  | 17640af 17830af  |
|                   | 21470af                                 |          |                  |
| 1500 1600         | USA, Amer Forces Network/AFRTS          | 4319usb  |                  |
|                   | 5446usb                                 | 5765usb  | 7811usb 12133usb |
|                   | 12759usb                                | 13362usb |                  |
| 1500 1600         | USA, BBG/Voice of America               | 4930af   |                  |
|                   | 6080af                                  | 6140as   | 7465as 7520as    |
|                   | 9485as                                  | 9760as   | 12150as 13570me  |
|                   | 15265af                                 | 15530me  | 15580af 17895af  |
| 1500 1600         | USA, FBN/WTJC Newport NC                | 9370na   |                  |
| 1500 1600         | USA, KNLS Anchor Point AK               | 9655as   |                  |
| 1500 1600         | USA, Overcomer Ministry                 | 13810me  |                  |
| 1500 1600         | USA, WBCQ Monticello ME                 | 9330am   |                  |
| 1500 1600 Sat/Sun | USA, WBCQ Monticello ME                 | 15420am  |                  |
| 1500 1600         | USA, WEWN/EWTN Irondale AL              | 15610eu  |                  |
| 1500 1600 Sat/Sun | USA, WHRI Cypress Creek SC              | 9795am   |                  |
|                   | 9840am                                  |          |                  |
| 1500 1600 Sun     | USA, WHRI Cypress Creek SC              | 21630af  |                  |
| 1500 1600         | USA, WINB Red Lion PA                   | 13570am  |                  |
| 1500 1600         | USA, WJHR Intl Milton FL                | 15550usb |                  |
| 1500 1600         | USA, WTTWW Lebanon TN                   | 9479va   |                  |
| 1500 1600         | USA, WWCR Nashville TN                  | 9980af   | 12160af          |
|                   | 13845eu                                 | 15825eu  |                  |
| 1500 1600         | USA, WWRB Manchester TN                 | 9385na   |                  |
| 1500 1600         | USA, WYFR/Family R Worldwide            | 6280as   |                  |
|                   | 13690as                                 | 15520as  |                  |
| 1500 1600         | Zambia, Christian Voice                 | 6065af   |                  |
| 1500 1600         | Zambia, CVC Intl/1 Africa               | 13590af  |                  |
| 1515 1530 Sat     | Australia, HCJB Global Australia        | 15340as  |                  |
| 1515 1530 f       | Canada, Bible Voice Broadcasting        | 15275as  |                  |
| 1525 1555 Sat/Sun | Swaziland, TWR Africa                   | 4760af   |                  |
| 1530 1545         | India, AIR/Aizawl                       | 5050do   | 7295do           |
| 1530 1545         | India, AIR/Bhopal                       | 4810do   | 7430do           |
| 1530 1545         | India, AIR/Chennai                      | 4920do   |                  |
| 1530 1545         | India, AIR/Guwahati                     | 4940do   |                  |
| 1530 1545         | India, AIR/Hyderabad                    | 4800do   |                  |
| 1530 1545         | India, AIR/Imphal                       | 4775do   |                  |
| 1530 1545         | India, AIR/Itanagar                     | 4990do   |                  |
| 1530 1545         | India, AIR/Jaipur                       | 4910do   | 7325do           |
| 1530 1545         | India, AIR/Jeyppore                     | 5040do   |                  |
| 1530 1545         | India, AIR/Kuresong                     | 4895do   |                  |
| 1530 1545         | India, AIR/Lucknow                      | 4880do   | 7440do           |
| 1530 1545         | India, AIR/Port Blair/Andaman & Nicobar | 4760do   |                  |
| 1530 1545         | India, AIR/Shillong                     | 4970do   |                  |
| 1530 1545         | India, AIR/Shimla                       | 4965do   | 6020do           |
| 1530 1545         | India, AIR/Thiruvananthapuram           | 5010do   |                  |
| 1530 1545         | India, AIR/R Kashmir                    | 4950do   |                  |
| 1530 1600         | Afghanistan, RTV Afghanistan            | 7200as   |                  |
| 1530 1600         | Australia, ABC/R Australia              | 11880pa  |                  |
| 1530 1600 DRM     | Belgium, The Disco Palace               | 15775as  |                  |
| 1530 1600 h       | Canada, Bible Voice Broadcasting        | 15275as  |                  |
| 1530 1600 Sun     | Clandestine, Sudan R Service            | 17745af  |                  |
| 1530 1600 smtwa   | Germany, AWR Europe                     | 15255as  |                  |
| 1530 1600 mtwas   | Indonesia, AWR Asia/Pacific             | 15255as  |                  |
| 1530 1600         | Iran, VO Islamic Rep of Iran            | 11945va  | 13780va          |
|                   | 13720al                                 |          |                  |
| 1530 1600         | Mongolia, Voice of Mongolia             | 12015as  |                  |
| 1530 1600         | Vatican City State, Vatican R           | 11850as  | 13765as          |
|                   | 17520as                                 |          |                  |
| 1530 1600 DRM     | Vatican City State, Vatican R           | 17815as  |                  |
| 1551 1600         | New Zealand, R New Zealand Intl         | 7440pa   |                  |
| 1551 1600 DRM     | New Zealand, R New Zealand Intl         | 6170pa   |                  |

**1600 UTC - 12PM EDT / 11AM CDT / 9AM PDT**

|           |                              |         |         |
|-----------|------------------------------|---------|---------|
| 1600 1627 | Iran, VO Islamic Rep of Iran | 11945va | 13780va |
|           | 13720al                      |         |         |
| 1600 1630 | Australia, ABC/R Australia   | 9540as  |         |



|                   |                                  |          |                  |
|-------------------|----------------------------------|----------|------------------|
| 1600 1630 DRM     | Belgium, The Disco Palace        | 15775as  |                  |
| 1600 1630         | Vietnam, VO Vietnam/Overseas Svc | 7220me   |                  |
|                   | 7280eu                           | 9550me   | 9730eu           |
| 1600 1657         | North Korea, Voice of Korea      | 3560eu   |                  |
|                   | 9990va                           | 11545va  |                  |
| 1600 1700         | Anguilla, University Network     | 11775na  |                  |
| 1600 1700         | Australia, ABC NT Alice Springs  | 2310do   |                  |
| 1600 1700         | Australia, ABC NT Katherine      | 2485do   |                  |
| 1600 1700         | Australia, ABC/R Australia       | 5940as   | 5995pa           |
|                   | 7240pa                           | 9475as   | 11660as 11880pa  |
| 1600 1700         | Bahrain, R Bahrain               | 6010me   |                  |
| 1600 1700         | Canada, CFRX Toronto ON          | 6070na   |                  |
| 1600 1700         | Canada, CFVP Calgary AB          | 6030na   |                  |
| 1600 1700         | Canada, CKZN St Johns NF         | 6160na   |                  |
| 1600 1700         | Canada, CKZU Vancouver BC        | 6160na   |                  |
| 1600 1700         | China, China R International     | 6060as   |                  |
|                   | 7235as                           | 7420af   | 9570af 11900af   |
|                   | 11940eu                          | 11965eu  | 13760eu          |
| 1600 1700         | Egypt, R Cairo                   | 15345af  |                  |
| 1600 1700         | Eqt Guinea, Pan Am BC/R Africa   | 15190af  |                  |
| 1600 1700         | Ethiopia, R Ethiopia             | 7235va   | 9560va           |
| 1600 1700 Sat/Sun | Germany, Mighty KBC Radio        | 6095eu   |                  |
| 1600 1700         | Malaysia, RTM Kajang/Traxx FM    | 7295do   |                  |
| 1600 1700 DRM     | New Zealand, R New Zealand Intl  | 6170pa   |                  |
| 1600 1700         | New Zealand, R New Zealand Intl  | 7440pa   |                  |
| 1600 1700         | Palau, T8WH/World Harvest R      | 15530as  |                  |
| 1600 1700 DRM     | Russia, Voice of Russia          | 6070as   | 7370eu           |
| 1600 1700         | Russia, Voice of Russia          | 4975as   | 7285me           |
|                   | 11985me                          |          |                  |
| 1600 1700         | South Korea, KBS World R         | 9515eu   | 9640as           |
| 1600 1700         | Taiwan, R Taiwan Intl            | 9435as   | 15485as          |
| 1600 1700         | Uganda, Dunamis Shortwave        | 4750do   |                  |
| 1600 1700         | UK, BBC World Service            | 3255af   | 5845as           |
|                   | 5975as                           | 6190af   | 9410as 11890as   |
|                   | 12095af                          | 13820me  | 15400af 17795af  |
|                   | 17830af                          | 21470af  |                  |
| 1600 1700         | USA, Amer Forces Network/AFRTS   | 4319usb  |                  |
|                   | 5446usb                          | 5765usb  | 7811usb 12133usb |
|                   | 12759usb                         | 13362usb |                  |
| 1600 1700         | USA, BBG/Voice of America        | 4930af   |                  |
|                   | 6080af                           | 7465as   | 12080af 13570af  |
|                   | 15470af                          | 15580af  |                  |
| 1600 1700         | USA, FBN/WTJC Newport NC         | 9370na   |                  |
| 1600 1700         | USA, Overcomer Ministry          | 15425as  |                  |
| 1600 1700         | USA, WBCQ Monticello ME          | 9330am   |                  |
| 1600 1700 Sat/Sun | USA, WBCQ Monticello ME          | 15420am  |                  |
| 1600 1700         | USA, WEWN/EWTN Irontdale AL      | 15610eu  |                  |
| 1600 1700 Sat/Sun | USA, WHRI Cypress Creek SC       | 9795am   |                  |
| 1600 1700         | USA, WHRI Cypress Creek SC       | 9840na   |                  |
|                   | 11630af                          |          |                  |
| 1600 1700         | USA, WINB Red Lion PA            | 13570am  |                  |
| 1600 1700         | USA, WJHR Intl Milton FL         | 15550usb |                  |
| 1600 1700         | USA, WTTWW Lebanon TN            | 9479va   |                  |
| 1600 1700         | USA, WWCN Nashville TN           | 9980af   | 12160af          |
|                   | 13845eu                          | 15825eu  |                  |
| 1600 1700         | USA, WWRB Manchester TN          | 9385na   |                  |
| 1600 1700         | USA, WYFR/Family R Worldwide     | 11850as  |                  |
| 1600 1700         | Zambia, Christian Voice          | 6065af   |                  |
| 1600 1700         | Zambia, CVC Intl/1 Africa        | 13590af  |                  |
| 1615 1630         | Vatican City State, Vatican R    | 15595va  |                  |
| 1630 1700         | Clandestine, Sudan R Service     | 17745af  |                  |
| 1630 1700         | Indonesia, AWR Asia/Pacific      | 11740as  |                  |
| 1630 1700         | Turkey, Voice of Turkey          | 15520as  |                  |
| 1630 1700         | USA, BBG/Voice of America        | 9490af   |                  |
|                   | 11655af                          | 13800af  |                  |
| 1645 1700         | Canada, Bible Voice Broadcasting | 15215me  |                  |

**1700 UTC - 1PM EDT / 12PM CDT / 10AM PDT**

|               |                                  |         |        |
|---------------|----------------------------------|---------|--------|
| 1700 1710     | Pakistan, Azad Kashmir R         | 3975do  | 4790do |
| 1700 1710     | Pakistan, PBC/R Pakistan         | 11575eu |        |
| 1700 1715 mf  | Canada, Bible Voice Broadcasting | 15215me |        |
| 1700 1720 h   | Canada, Bible Voice Broadcasting | 15215me |        |
| 1700 1725     | Turkey, Voice of Turkey          | 15520as |        |
| 1700 1730     | Australia, ABC/R Australia       | 11660as |        |
| 1700 1730     | USA, BBG/Voice of America        | 6080af  |        |
|               | 11795va                          | 17895af |        |
| 1700 1730     | Vietnam, VO Vietnam/Overseas Svc | 9625eu  |        |
| 1700 1750 DRM | New Zealand, R New Zealand Intl  | 6170pa  |        |

|                   |                                    |          |                  |
|-------------------|------------------------------------|----------|------------------|
| 1700 1750         | New Zealand, R New Zealand Intl    | 7440pa   |                  |
| 1700 1755         | South Africa, Channel Africa       | 15235af  |                  |
| 1700 1756 DRM     | Romania, R Romania Intl            | 9535eu   |                  |
| 1700 1756         | Romania, R Romania Intl            | 11740eu  | 11740eu          |
| 1700 1800         | Anguilla, University Network       | 11775na  |                  |
| 1700 1800         | Australia, ABC NT Alice Springs    | 2310do   |                  |
| 1700 1800         | Australia, ABC NT Katherine        | 2485do   |                  |
| 1700 1800         | Australia, ABC/R Australia         | 5995pa   | 9475as           |
|                   | 9500pa                             | 9580pa   | 11880pa          |
| 1700 1800         | Bahrain, R Bahrain                 | 6010me   |                  |
| 1700 1800asm      | Canada, Bible Voice Broadcasting   | 15215me  |                  |
| 1700 1800         | Canada, CFRX Toronto ON            | 6070na   |                  |
| 1700 1800         | Canada, CFVP Calgary AB            | 6030na   |                  |
| 1700 1800         | Canada, CKZN St Johns NF           | 6160na   |                  |
| 1700 1800         | Canada, CKZU Vancouver BC          | 6160na   |                  |
| 1700 1800         | China, China R International       | 6090as   |                  |
|                   | 6140as                             | 6145eu   | 6165me 7235as    |
|                   | 7265af                             | 7410as   | 7420as 9570af    |
|                   | 9695eu                             | 11900af  | 13760eu          |
| 1700 1800         | Egypt, R Cairo                     | 15345af  |                  |
| 1700 1800         | Eqt Guinea, Pan Am BC/R Africa     | 15190af  |                  |
| 1700 1800         | Malaysia, RTM Kajang/Traxx FM      | 7295do   |                  |
| 1700 1800         | Poland, Polish Radio/External Svc  | 9955na   |                  |
| 1700 1800 DRM     | Russia, Voice of Russia            | 7370eu   |                  |
| 1700 1800         | Russia, Voice of Russia            | 4975va   | 7285va           |
|                   | 11985af                            | 12040eu  |                  |
| 1700 1800         | Swaziland, TWR Africa              | 3200af   |                  |
| 1700 1800         | Taiwan, R Taiwan Intl              | 15690af  |                  |
| 1700 1800         | UK, BBC World Service              | 3255af   | 5845as           |
|                   | 5975as                             | 6190af   | 7565as 9410as    |
|                   | 12095af                            | 15400af  | 15420af 17640af  |
|                   | 17795af                            | 17830af  |                  |
| 1700 1800         | USA, Amer Forces Network/AFRTS     | 4319usb  |                  |
|                   | 5446usb                            | 5765usb  | 7811usb 12133usb |
|                   | 12759usb                           | 13362usb |                  |
| 1700 1800         | USA, BBG/Voice of America          | 11795af  |                  |
|                   | 15580af                            |          |                  |
| 1700 1800         | USA, FBN/WTJC Newport NC           | 9370na   |                  |
| 1700 1800         | USA, Overcomer Ministry            | 15425as  |                  |
| 1700 1800         | USA, WBCQ Monticello ME            | 9330am   | 15420am          |
| 1700 1800         | USA, WEWN/EWTN Irontdale AL        | 15610eu  |                  |
| 1700 1800         | USA, WHRI Cypress Creek SC         | 9840na   |                  |
|                   | 21630af                            |          |                  |
| 1700 1800         | USA, WINB Red Lion PA              | 13570am  |                  |
| 1700 1800         | USA, WJHR Intl Milton FL           | 15550usb |                  |
| 1700 1800         | USA, WTTWW Lebanon TN              | 9479va   |                  |
| 1700 1800         | USA, WWCN Nashville TN             | 9980af   | 12160af          |
|                   | 13845eu                            | 15825eu  |                  |
| 1700 1800         | USA, WWRB Manchester TN            | 9385na   |                  |
| 1700 1800         | USA, WYFR/Family R Worldwide       | 7395af   |                  |
|                   | 17545af                            |          |                  |
| 1700 1800         | Zambia, Christian Voice            | 4965as   |                  |
| 1700 1800         | Zambia, CVC Intl/1 Africa          | 13590af  |                  |
| 1720 1740 Sat/Sun | USA, BBG/Voice of America/Studio 7 | 74930af  |                  |
|                   | 7210af                             | 9725af   |                  |
| 1730 1745 h       | Canada, Bible Voice Broadcasting   | 15215me  |                  |
| 1730 1745         | India, AIR/Bhopal                  | 4810do   | 7430do           |
| 1730 1745         | India, AIR/Chennai                 | 4920do   |                  |
| 1730 1745         | India, AIR/Guwahati                | 4940do   |                  |
| 1730 1745         | India, AIR/Hyderabad               | 4800do   |                  |
| 1730 1745         | India, AIR/Imphal                  | 4775do   |                  |
| 1730 1745         | India, AIR/Jaipur                  | 4910do   | 7325do           |
| 1730 1745         | India, AIR/Kuresong                | 4895do   |                  |
| 1730 1745         | India, AIR/Lucknow                 | 4880do   | 7440do           |
| 1730 1745         | India, AIR/Shimla                  | 4965do   | 6020do           |
| 1730 1745         | India, AIR/Thiruvananthapuram      | 5010do   |                  |
| 1730 1745         | India, AIR/R Kashmir               | 4950do   |                  |
| 1730 1800         | Australia, ABC/R Australia         | 6080pa   |                  |
| 1730 1800 Sun     | Italy, IRRS SW                     | 7290va   |                  |
| 1730 1800 m       | South Africa, R Mirror Intl        | 3230af   |                  |
| 1730 1800         | USA, BBG/Voice of America          | 6080af   |                  |
|                   | 12015va                            | 17895af  |                  |
| 1730 1800 mtwh    | USA, BBG/Voice of America/Studio 7 | 74930af  |                  |
|                   | 7210af                             | 9725af   |                  |
| 1730 1800         | Vatican City State, Vatican R      | 11625af  | 13765af          |
|                   | 15570af                            |          |                  |
| 1745 1800 Sat     | Canada, Bible Voice Broadcasting   | 17515af  |                  |
| 1745 1800 DRM     | India, AIR/External Service        | 9950eu   |                  |
| 1745 1800         | India, AIR/External Service        | 7400af   | 7550eu           |
|                   | 9415af                             | 11580af  | 11670as 11935af  |
|                   | 13695af                            |          |                  |

1751 1800 New Zealand, R New Zealand Intl 9615pa  
 1751 1800 DRM New Zealand, R New Zealand Intl 7440pa

**1800 UTC - 2PM EDT / 1PM CDT / 11AM PDT**

1800 1830 w Austria, AWR Europe 15325af  
 1800 1830 Japan, R Japan NHK World 15720af  
 1800 1830 South Africa, AWR Africa 3215af 3345af  
 1800 1830 m South Africa, R Mirror Intl 3230af  
 1800 1830 Tanzania, Zanzibar BC/VO Tanzania 11735do  
 1800 1830 UK, BBC World Service 5850as 5975as  
 1800 1830 USA, BBG/Voice of America 6080af  
 17895af  
 1800 1830 Sat/Sun USA, BBG/Voice of America 4930af  
 1800 1830 USA, BBG/Voice of America 9850af  
 1800 1836 DRM New Zealand, R New Zealand Intl 7440pa  
 1800 1836 New Zealand, R New Zealand Intl 9615pa  
 1800 1857 North Korea, Voice of Korea 13760eu  
 15245eu  
 1800 1900 Anguilla, University Network 11775na  
 1800 1900 mtwhf Argentina, RAE 15345eu  
 1800 1900 Australia, ABC NT Alice Springs 2310do  
 1800 1900 Australia, ABC NT Katherine 2485do  
 1800 1900 Australia, ABC/R Australia 6080pa 9500pa  
 9580pa 9710pa 11880pa  
 1800 1900 Bahrain, R Bahrain 6010me  
 1800 1900 Sat Canada, Bible Voice Broadcasting 9430me  
 1800 1900 Sun Canada, Bible Voice Broadcasting 6130eu  
 15215me  
 1800 1900 Canada, CFRX Toronto ON 6070na  
 1800 1900 Canada, CFVP Calgary AB 6030na  
 1800 1900 Canada, CKZN St Johns NF6160na  
 1800 1900 Canada, CKZU Vancouver BC 6160na  
 1800 1900 China, China R International 6175eu  
 9600eu 13760eu  
 1800 1900 mtwhfa Ecuador, HCJB/LV de los Andes 3995eu  
 1800 1900 Eqt Guinea, Pan Am BC/R Africa 15190af  
 1800 1900 DRM India/AIR/External Service 9950eu  
 1800 1900 India/AIR/External Service 7400af 7550as  
 9415af 9445af 11580af 11670eu  
 11935af 13695af  
 1800 1900 fa Italy, IRRS SW 7290va  
 1800 1900 Kuwait, R Kuwait 15540eu  
 1800 1900 Malaysia, RTM Kajang/Traxx FM 7295do  
 1800 1900 DRM Russia, Voice of Russia 7370eu 9880eu  
 1800 1900 Russia, Voice of Russia 4975me 9900va  
 12040eu  
 1800 1900 South Korea, KBS World R 7275eu  
 1800 1900 Swaziland, TWR Africa 3200af 9500af  
 1800 1900 Taiwan, R Taiwan Intl 6155eu  
 1800 1900 UK, BBC World Service 3255af 5875me  
 5950as 6190af 11810af 12095af  
 15400af 15420af 17795af  
 1800 1900 USA, Amer Forces Network/AFRTS 4319usb  
 5446usb 5765usb 7811usb 12133usb  
 12759usb 13362usb  
 1800 1900 USA, BBG/Voice of America 12015af  
 15580af  
 1800 1900 USA, FBN/WTJC Newport NC 9370na  
 1800 1900 USA, KJES Vado NM 15385na  
 1800 1900 USA, WBCQ Monticello ME9330am 15420am  
 1800 1900 USA, WEWN/EWTN Irondale AL 15610af  
 1800 1900 USA, WHRI Cypress Creek SC 9840na  
 21630af  
 1800 1900 USA, WINB Red Lion PA 13570am  
 1800 1900 USA, WJHR Intl Milton FL 15550usb  
 1800 1900 USA, WTWW Lebanon TN 9479va  
 1800 1900 USA, WWCR Nashville TN 9980af 12160af  
 13845eu 15825eu  
 1800 1900 USA, WWRB Manchester TN 9385na  
 1800 1900 USA, WYFR/Family R Worldwide 5905af  
 9610af 9925af 13750af  
 1800 1900 Zambia, Christian Voice 4965af  
 1800 1900 Zambia, CVC Intl/1 Africa 13590af  
 1815 1845 Sun Canada, Bible Voice Broadcasting 6130eu  
 9430me  
 1830 1900 f Canada, Bible Voice Broadcasting 17515af  
 1830 1900 Sun Italy, IRRS SW 7290va  
 1830 1900 mtwhf Moldova, R PMR/Pridnestrovye 9665eu

1830 1900 DRM/mtwhf Nigeria, Voice of Nigeria 15120af  
 1830 1900 Serbia, International R Serbia 6100eu  
 1830 1900 South Africa, AWR Africa 11840af  
 1830 1900 Turkey, Voice of Turkey 9785va  
 1830 1900 UK, BBC World Service 9410af  
 1830 1900 USA, BBG/Voice of America 4930af  
 6080af 9850af  
 1837 1900 New Zealand, R New Zealand Intl 9615pa  
 1837 1900 DRM New Zealand, R New Zealand Intl 9890pa

**1900 UTC - 3PM EDT / 2PM CDT / 12PM PDT**

1900 1925 Turkey, Voice of Turkey 9785va  
 1900 1927 Germany, Deutsche Welle 9735af  
 1900 1930 f Canada, Bible Voice Broadcasting 17515af  
 1900 1930 Germany, Deutsche Welle 7365af 11800af  
 1900 1930 USA, BBG/Voice of America 9850af  
 1900 1930 Vietnam, VO Vietnam/Overseas Svc 7280eu  
 9730eu  
 1900 1945 DRM India/AIR/External Service 9950eu  
 1900 1945 India/AIR/External Service 7400af 7550eu  
 9415af 9445af 11580af 11670eu  
 11935af 13695af  
 1900 1950 DRM New Zealand, R New Zealand Intl 9890pa  
 1900 1950 New Zealand, R New Zealand Intl 9615pa  
 1900 1957 North Korea, Voice of Korea 3560eu  
 7210af 9975va 11535va 11910af  
 1900 2000 Anguilla, University Network 11775na  
 1900 2000 Australia, ABC NT Alice Springs 2310do  
 1900 2000 Australia, ABC NT Katherine 2485do  
 1900 2000 Australia, ABC/R Australia 6080pa 9475as  
 9500pa 9580pa 9710pa 11660pa  
 11880pa  
 1900 2000 Bahrain, R Bahrain 6010me  
 1900 2000 Canada, CFRX Toronto ON 6070na  
 1900 2000 Canada, CFVP Calgary AB 6030na  
 1900 2000 Canada, CKZN St Johns NF6160na  
 1900 2000 Canada, CKZU Vancouver BC 6160na  
 1900 2000 China, China R International 7295va  
 9435af 9440af  
 1900 2000 Cuba, R Havana Cuba 11760am  
 1900 2000 Egypt, R Cairo 15290af  
 1900 2000 Eqt Guinea, Pan Am BC/R Africa 15190af  
 1900 2000 Indonesia, VO Indonesia 9526va  
 1900 2000 Kuwait, R Kuwait 15540eu  
 1900 2000 Malaysia, RTM Kajang/Traxx FM 7295do  
 1900 2000 Micronesia, V6MP/Cross R/Pohnpei 4755as  
 1900 2000 DRM/mtwhf Nigeria, Voice of Nigeria 15120af  
 1900 2000 DRM Russia, Voice of Russia 6155eu  
 1900 2000 Russia, Voice of Russia 12040eu  
 1900 2000 mtwhf Spain, R Exterior de Espana 9665af 11620af  
 1900 2000 Swaziland, TWR Africa 3200af  
 1900 2000 Thailand, R Thailand World Svc 7205eu  
 1900 2000 UK, BBC World Service 3255af 5875me  
 5950as 6005af 6190af 9410af  
 11810af 12095af 15400af 17795as  
 1900 2000 USA, Amer Forces Network/AFRTS 4319usb  
 5446usb 5765usb 7811usb 12133usb  
 12759usb 13362usb  
 1900 2000 USA, BBG/Voice of America 4930af  
 4940af 6080af 7485me 9490me  
 15580af  
 1900 2000 USA, FBN/WTJC Newport NC 9370na  
 1900 2000 USA, Overcomer Ministry 9400eu  
 1900 2000 USA, WBCQ Monticello ME9330am 15420am  
 1900 2000 USA, WEWN/EWTN Irondale AL 15610af  
 1900 2000 USA, WHRI Cypress Creek SC 9840na  
 21630af  
 1900 2000 USA, WINB Red Lion PA 13570am  
 1900 2000 USA, WJHR Intl Milton FL 15550usb  
 1900 2000 USA, WTWW Lebanon TN 9479va  
 1900 2000 USA, WWCR Nashville TN 9980af 12160af  
 13845eu 15825eu  
 1900 2000 USA, WWRB Manchester TN 9385na  
 1900 2000 USA, WYFR/Family R Worldwide 9775af  
 9925af  
 1900 2000 Zambia, Christian Voice 4965af  
 1900 2000 Zambia, CVC Intl/1 Africa 13590af  
 1905 1920 Sat Mali, ORTM/R Mali 9635do



|               |                                 |         |        |
|---------------|---------------------------------|---------|--------|
| 1930 1957     | Germany, Deutsche Welle         | 7365af  |        |
| 1930 2000     | Germany, Deutsche Welle         | 11800af |        |
| 1930 2000     | Iran, VO Islamic Rep of Iran    | 9540eu  | 9800eu |
|               | 11750af                         | 11885af |        |
| 1930 2000 Sat | USA, Pan Amer Broadcasting      | 9515af  |        |
| 1951 2000     | New Zealand, R New Zealand Intl | 11725pa |        |
| 1951 2000 DRM | New Zealand, R New Zealand Intl | 15720pa |        |

### 2000 UTC - 4PM EDT / 3PM CDT / 1PM PDT

|                  |                                      |          |          |
|------------------|--------------------------------------|----------|----------|
| 2000 2027        | Iran, VO Islamic Rep of Iran         | 9540eu   | 9800eu   |
|                  | 11750af                              | 11885af  |          |
| 2000 2030 mtwhfa | Albania, R Tirana                    | 7465eu   |          |
| 2000 2030        | Australia, ABC/R Australia           | 6080pa   | 9500pa   |
| 2000 2030        | Egypt, R Cairo                       | 15290af  |          |
| 2000 2030 Sat    | Swaziland, TWR Africa                | 3200af   |          |
| 2000 2030        | USA, BBG/Voice of America            |          | 4930af   |
|                  | 6080af                               |          |          |
| 2000 2030        | Vatican City State, Vatican R        | 9755af   | 11625af  |
| 2000 2057        | Germany, Deutsche Welle              | 9490af   |          |
| 2000 2100        | Anguilla, University Network         |          | 11775na  |
| 2000 2100        | Australia, ABC NT Alice Springs      |          | 2310do   |
| 2000 2100        | Australia, ABC NT Katherine          |          | 2485do   |
| 2000 2100        | Australia, ABC NT Tennant Creek      |          | 2325do   |
| 2000 2100        | Australia, ABC/R Australia           | 9580pa   | 11650pa  |
|                  | 11660pa                              | 12080pa  | 15515pa  |
| 2000 2100        | Bahrain, R Bahrain                   | 6010me   |          |
| 2000 2100        | Belarus, R Belarus                   | 7255eu   | 11730eu  |
| 2000 2100 DRM    | Belgium, The Disco Palace            | 17875na  |          |
| 2000 2100        | Canada, CFRX Toronto ON              | 6070na   |          |
| 2000 2100        | Canada, CFVP Calgary AB              | 6030na   |          |
| 2000 2100        | Canada, CKZN St Johns NF             | 6160na   |          |
| 2000 2100        | Canada, CKZU Vancouver BC            |          | 6160na   |
| 2000 2100        | China, China R International         |          | 5960eu   |
|                  | 5985af                               | 7285eu   | 7295va   |
|                  | 9440af                               | 9600eu   | 7415eu   |
| 2000 2100 f      | Clandestine, JSR/Shiokaze/Sea Breeze |          | 5910as   |
| 2000 2100        | Eqt Guinea, Pan Am BC/R Africa       |          | 15190af  |
| 2000 2100        | Germany, Deutsche Welle              | 6150af   | 11800af  |
| 2000 2100        | Kuwait, R Kuwait                     | 15540eu  |          |
| 2000 2100        | Malaysia, RTM Kajang/Traxx FM        |          | 7295do   |
| 2000 2100        | Micronesia, V6MP/Cross R/Pohnpei     |          | 4755as   |
| 2000 2100 DRM    | New Zealand, R New Zealand Intl      |          | 15720pa  |
| 2000 2100        | New Zealand, R New Zealand Intl      |          | 11725pa  |
| 2000 2100 DRM    | Russia, Voice of Russia              | 6155eu   |          |
| 2000 2100        | Russia, Voice of Russia              | 12040eu  |          |
| 2000 2100        | South Africa, CVC 1 Africa R         |          | 9505af   |
|                  | 13590af                              |          |          |
| 2000 2100        | UK, BBC World Service                | 3255af   | 6005af   |
|                  | 6190af                               | 9410af   | 9855af   |
|                  | 12095af                              | 15400af  |          |
| 2000 2100        | USA, Amer Forces Network/AFRTS       |          | 4319usb  |
|                  | 5446usb                              | 5765usb  | 7811usb  |
|                  | 12759usb                             | 13362usb | 12133usb |
| 2000 2100        | USA, BBG/Voice of America            |          | 4930af   |
|                  | 7485me                               | 15580af  |          |
| 2000 2100 mtwhf  | USA, BBG/Voice of America            |          | 9480me   |
| 2000 2100        | USA, FBN/WTJC Newport NC             |          | 9370na   |
| 2000 2100        | USA, Overcomer Ministry              | 9400eu   |          |
| 2000 2100        | USA, WBCQ Monticello ME              | 7490am   | 9330am   |
|                  | 15420am                              |          |          |
| 2000 2100        | USA, WWRN/EWTN Irondale AL           |          | 15610af  |
| 2000 2100 mtwhfa | USA, WHRI Cypress Creek SC           |          | 21630af  |
| 2000 2100        | USA, WHRI Cypress Creek SC           |          | 17510va  |
| 2000 2100        | USA, WINB Red Lion PA                | 13570am  |          |
| 2000 2100        | USA, WJHR Intl Milton FL             | 15550usb |          |
| 2000 2100        | USA, WTTWW Lebanon TN                | 9479va   |          |
| 2000 2100        | USA, WWCN Nashville TN               | 9980af   | 12160af  |
|                  | 13845eu                              | 15825eu  |          |
| 2000 2100        | USA, WWRB Manchester TN              |          | 9385na   |
| 2000 2100        | USA, WYFR/Family R Worldwide         |          | 15195af  |
| 2000 2100        | Zambia, Christian Voice              | 4965af   |          |
| 2000 2100        | Zambia, CVC Intl/1 Africa            | 9505as   |          |
| 2030 2045        | Thailand, R Thailand World Svc       |          | 9680eu   |
| 2030 2056 DRM    | Romania, R Romania Intl              | 9700eu   |          |
| 2030 2056        | Romania, R Romania Intl              | 11880na  | 13800na  |
|                  | 15220na                              |          |          |
| 2030 2100        | Australia, ABC/R Australia           | 9500pa   | 11695as  |
|                  | 12080pa                              |          |          |

|                   |                                  |         |         |
|-------------------|----------------------------------|---------|---------|
| 2030 2100 mtwhf   | Moldova, R PMR/Pridnestrovye     |         | 9665eu  |
| 2030 2100         | Turkey, Voice of Turkey          | 7205va  |         |
| 2030 2100         | USA, BBG/Voice of America        |         | 6080af  |
|                   | 7555as                           |         |         |
| 2030 2100 Sat/Sun | USA, BBG/Voice of America        |         | 4940af  |
| 2030 2100         | Vietnam, VO Vietnam/Overseas Svc |         | 7220me  |
|                   | 7280eu                           | 9730me  | 9730eu  |
| 2045 2100         | India/AIR/External Service       | 7550eu  | 9445eu  |
|                   | 9910pa                           | 11620pa | 11670eu |
| 2045 2100 DRM     | India/AIR/External Service       | 9950eu  | 11715pa |

### 2100 UTC - 5PM EDT / 4PM CDT / 2PM PDT

|               |                                 |         |         |
|---------------|---------------------------------|---------|---------|
| 2100 2125     | Turkey, Voice of Turkey         | 7205va  |         |
| 2100 2130     | Australia, ABC NT Alice Springs |         | 2310do  |
| 2100 2130     | Australia, ABC NT Katherine     |         | 2485do  |
| 2100 2130     | Australia, ABC NT Tennant Creek |         | 2325do  |
| 2100 2130     | Austria, AWR Europe             | 11955af |         |
| 2100 2130     | Serbia, International R Serbia  |         | 6100eu  |
| 2100 2130     | South Korea, KBS World R        | 3955eu  |         |
| 2100 2150     | New Zealand, R New Zealand Intl |         | 11725pa |
| 2100 2150 DRM | New Zealand, R New Zealand Intl |         | 15720pa |
| 2100 2157     | North Korea, Voice of Korea     |         | 13760eu |
|               | 15245eu                         |         |         |
| 2100 2200     | Angola, Angolan National R      |         | 7217af  |
| 2100 2200     | Anguilla, University Network    |         | 11775na |
| 2100 2200     | Australia, ABC/R Australia      | 9500pa  | 11695as |
|               | 13630pa                         | 15515pa | 11650pa |
|               | 21740pa                         |         |         |
| 2100 2200     | Bahrain, R Bahrain              | 6010me  |         |
| 2100 2200     | Belarus, R Belarus              | 7255eu  | 11730eu |
| 2100 2200     | Canada, CFRX Toronto ON         | 6070na  |         |
| 2100 2200     | Canada, CFVP Calgary AB         | 6030na  |         |
| 2100 2200     | Canada, CKZN St Johns NF        | 6160na  |         |
| 2100 2200     | Canada, CKZU Vancouver BC       |         | 6160na  |
| 2100 2200     | China, China R International    |         | 5960eu  |
|               | 7205af                          | 7285eu  | 7325af  |
|               | 9600eu                          | 7415eu  |         |

## NOW AVAILABLE

Radio hobbyists interested in receiving and identifying radio stations in the HF/VHF/UHF radio spectrums now have a new whopping 1414 page CD-ROM publication to aid them.



**International Callsign Handbook** is a concise world directory of various types of radio station identifications covering the military, government, maritime, aeronautical, and fixed radio stations on CD-ROM. Thousands of callsigns and other types of identifiers have been collected from our own personal log book, official sources and dedicated hobbyists who contributed their material.

**World QSL Book** - Radio hobbyists interested in receiving verifications from radio station now have a new CD-ROM publication to aid them in the art of QSLing. This 528-page eBook covers every aspect of collecting QSL cards and other acknowledgments from stations heard in the HF spectrum.

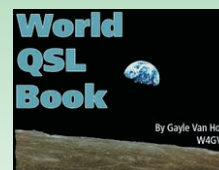

*"I'm impressed. This is a comprehensive collection of worldwide radio identifiers likely (and even some less likely) to be heard on the air. Over the years the Van Horns have earned the well-deserved respect of the monitoring community. Accurately assembling a collection like this is a mammoth undertaking. Congratulations on a job well done."*  
Bob Grove - December 2008 What's New Column, Monitoring Times magazine

Both books may be ordered directly from Teak Publishing via email at [teakpub@brmemc.net](mailto:teakpub@brmemc.net) or via our two main dealers, Grove Enterprises, [www.grove-ent.com](http://www.grove-ent.com), and Universal Radio, [www.universal-radio.com](http://www.universal-radio.com).

**TEAK**  
Publishing  
PO Box 297  
Brasstown, NC 28902  
[teakpub@brmemc.net](mailto:teakpub@brmemc.net)

From Teak Publishing either book is \$19.95 plus \$3.00 (US) and \$5.00 (Int'l) first class mail. Paypal, Cash, Check or Money Order accepted. NC residents add state sales tax. **Dealer inquiries/orders welcomed.**

|                   |                                  |                 |  |
|-------------------|----------------------------------|-----------------|--|
| 2100 2200         | Eqt Guinea, Pan Am BC/R Africa   | 15190af         |  |
| 2100 2200         | Germany, Deutsche Welle          | 11800af 11830af |  |
| 2100 2200         | India/AIR/External Service       | 7550eu 9445eu   |  |
|                   | 9910pa 11620pa 11670eu           | 11715pa         |  |
| 2100 2200 DRM     | India/AIR/External Service       | 9950eu          |  |
| 2100 2200         | Malaysia, RTM Kajang/Traxx FM    | 7295do          |  |
| 2100 2200         | Micronesia, V6MP/Cross R/Pohnpei | 4755 as         |  |
| 2100 2200 DRM     | Russia, Voice of Russia          | 6155eu          |  |
| 2100 2200         | South Africa, CVC 1 Africa R     | 9505af          |  |
|                   | 13590af                          |                 |  |
| 2100 2200 Sat/Sun | Spain, R Exterior de Espana      | 9650eu          |  |
| 2100 2200         | Syria, R Damascus                | 9330va          |  |
| 2100 2200         | UK, BBC World Service            | 3255af 3915as   |  |
|                   | 5875as 5905af 6005af 6190af      | 6190af          |  |
|                   | 6195va 9410af 12095af            |                 |  |
| 2100 2200         | USA, Amer Forces Network/AFRTS   | 4319usb         |  |
|                   | 5446usb 5765usb 7811usb          | 12133usb        |  |
|                   | 12759usb 13362usb                |                 |  |
| 2100 2200         | USA, BBG/Voice of America        | 6080af          |  |
|                   | 7555as 15580af                   |                 |  |
| 2100 2200         | USA, FBN/WTJC Newport NC         | 9370na          |  |
| 2100 2200         | USA, Overcomer Ministry          | 9400eu          |  |
| 2100 2200         | USA, WBCQ Monticello ME7490am    | 9330am          |  |
| 2100 2200         | USA, WEWN/EWTN Irondale AL       | 15610af         |  |
| 2100 2200         | USA, WHRI Cypress Creek SC       | 17510va         |  |
| 2100 2200         | USA, WINB Red Lion PA            | 9265am          |  |
| 2100 2200         | USA, WJHR Intl Milton FL         | 15550usb        |  |
| 2100 2200         | USA, WTWW Lebanon TN             | 9479va          |  |
| 2100 2200         | USA, WWCR Nashville TN           | 6875eu 9350af   |  |
|                   | 9980af 13845eu                   |                 |  |
| 2100 2200         | USA, WWRB Manchester TN          | 9385na          |  |
| 2100 2200         | USA, WYFR/Family R Worldwide     | 12070af         |  |
| 2100 2200         | Zambia, Christian Voice          | 4965af          |  |
| 2100 2200         | Zambia, CVC Intl/1 Africa        | 9505as          |  |
| 2115 2200         | Egypt, R Cairo                   | 11890eu         |  |
| 2130 2200         | Australia, ABC NT Alice Springs  | 4835do          |  |
| 2130 2200         | Australia, ABC NT Katherine      | 5025do          |  |
| 2145 2200         | India/AIR/R Kashmir              | 4950do          |  |
| 2151 2200         | New Zealand, R New Zealand Intl  | 15720pa         |  |
| 2151 2200 DRM     | New Zealand, R New Zealand Intl  | 17675pa         |  |

**2200 UTC - 6PM EDT / 5PM CDT / 3PM PDT**

|                 |                                  |                 |  |
|-----------------|----------------------------------|-----------------|--|
| 2200 2230       | India/AIR/External Service       | 7550eu 9445eu   |  |
|                 | 9910pa 11620pa 11670eu           | 11715pa         |  |
| 2200 2230 DRM   | India/AIR/External Service       | 9950as          |  |
| 2200 2245       | Egypt, R Cairo                   | 11890eu         |  |
| 2200 2255       | Turkey, Voice of Turkey          | 9830va          |  |
| 2200 2256       | Romania, R Romania Intl          | 7435eu 9540eu   |  |
|                 | 9790eu 11940eu                   |                 |  |
| 2200 2300       | Anguilla, University Network     | 6090na          |  |
| 2200 2300       | Australia, ABC NT Alice Springs  | 4835do          |  |
| 2200 2300       | Australia, ABC NT Katherine      | 5025do          |  |
| 2200 2300       | Australia, ABC/R Australia       | 9855as 12080pa  |  |
|                 | 13630pa 15230pa 15240as 15415pa  | 15515pa 21740pa |  |
| 2200 2300       | Bahrain, R Bahrain               | 6010me          |  |
| 2200 2300       | Canada, CFRX Toronto ON          | 6070na          |  |
| 2200 2300       | Canada, CFVP Calgary AB          | 6030na          |  |
| 2200 2300       | Canada, CKZN St Johns NF         | 6160na          |  |
| 2200 2300       | Canada, CKZU Vancouver BC        | 6160na          |  |
| 2200 2300       | China, China R International     | 9590as          |  |
| 2200 2300       | Eqt Guinea, Pan Am BC/R Africa   | 15190af         |  |
| 2200 2300       | Malaysia, RTM Kajang/Traxx FM    | 7295do          |  |
| 2200 2300       | Micronesia, V6MP/Cross R/Pohnpei | 4755 as         |  |
| 2200 2300       | New Zealand, R New Zealand Intl  | 15720pa         |  |
| 2200 2300 DRM   | New Zealand, R New Zealand Intl  | 17675pa         |  |
| 2200 2300 Sat   | Palau, T8WH/World Harvest R      | 9930as          |  |
| 2200 2300       | Russia, Voice of Russia          | 9800va          |  |
| 2200 2300       | UK, BBC World Service            | 3915as 5875as   |  |
|                 | 5905as 6195as 7490as 9580as      |                 |  |
|                 | 9730af 9740as 12095af            |                 |  |
| 2200 2300       | USA, Amer Forces Network/AFRTS   | 4319usb         |  |
|                 | 5446usb 5765usb 7811usb          | 12133usb        |  |
|                 | 12759usb 13362usb                |                 |  |
| 2200 2300       | USA, BBG/Voice of America        | 5755as          |  |
| 2200 2300 mtwhs | USA, BBG/Voice of America        | 5895as          |  |
|                 | 5915as 7480as 7575as             | 12150as         |  |

|                 |                               |               |  |
|-----------------|-------------------------------|---------------|--|
| 2200 2300       | USA, FBN/WTJC Newport NC      | 9370na        |  |
| 2200 2300       | USA, Overcomer Ministry       | 9400as        |  |
| 2200 2300       | USA, WBCQ Monticello ME7490am | 9330am        |  |
| 2200 2300       | USA, WEWN/EWTN Irondale AL    | 15610me       |  |
| 2200 2300       | USA, WHRI Cypress Creek SC    | 11775va       |  |
|                 | 13620na 17510va               |               |  |
| 2200 2300 twhf  | USA, WINB Red Lion PA         | 9265am        |  |
| 2200 2300       | USA, WTWW Lebanon TN          | 9479va        |  |
| 2200 2300       | USA, WWCR Nashville TN        | 6875eu 9350af |  |
|                 | 9980af 13845eu                |               |  |
| 2200 2300       | USA, WWRB Manchester TN       | 9385na        |  |
| 2200 2300       | USA, WYFR/Family R Worldwide  | 6115na        |  |
| 2200 2300       | Zambia, Christian Voice       | 4965af        |  |
| 2230 2300       | Indonesia, AWR Asia/Pacific   | 9730as        |  |
| 2230 2300 mtwhf | Moldova, R PMR/Pridnestrovye  | 9665eu        |  |
| 2230 2300       | USA, BBG/Voice of America     | 7460as        |  |
|                 | 9570as 11840as 15340as        |               |  |
| 2230 2300       | USA, WYFR/Family R Worldwide  | 6115af        |  |
|                 | 11580af 15255af               |               |  |
| 2245 2300       | India/AIR/External Service    | 6055as 9705as |  |
|                 | 9950as 11670as 13605as        |               |  |
| 2245 2300 DRM   | India/AIR/External Service    | 11645as       |  |
| 2245 2300       | India/AIR/R Kashmir           | 4950do        |  |

**2300 UTC - 7PM EDT / 6PM CDT / 4PM PDT**

|                   |                                  |                                |  |
|-------------------|----------------------------------|--------------------------------|--|
| 2300 0000         | Anguilla, University Network     | 6090na                         |  |
| 2300 0000         | Australia, ABC NT Alice Springs  | 4835do                         |  |
| 2300 0000         | Australia, ABC NT Katherine      | 5025do                         |  |
| 2300 0000         | Australia, ABC/R Australia       | 9855as 12080pa                 |  |
|                   | 13630pa 15230pa 15415pa 15515pa  | 17795pa 19000pa 21740pa        |  |
| 2300 0000         | Bahrain, R Bahrain               | 6010me                         |  |
| 2300 0000         | Canada, CFRX Toronto ON          | 6070na                         |  |
| 2300 0000         | Canada, CFVP Calgary AB          | 6030na                         |  |
| 2300 0000         | Canada, CKZN St Johns NF         | 6160na                         |  |
| 2300 0000         | Canada, CKZU Vancouver BC        | 6160na                         |  |
| 2300 0000         | China, China R International     | 9590as                         |  |
|                   | 5990ca 6145na 7350eu 7410as      | 9610as 11690as 11790as 11840na |  |
| 2300 0000         | Cuba, R Havana Cuba              | 5040va                         |  |
| 2300 0000         | Egypt, R Cairo                   | 9965na                         |  |
| 2300 0000         | India/AIR/External Service       | 6055as 9705as                  |  |
|                   | 9950as 11670as 13605as           |                                |  |
| 2300 0000 DRM     | India/AIR/External Service       | 11645as                        |  |
| 2300 0000         | Malaysia, RTM Kajang/Traxx FM    | 7295do                         |  |
| 2300 0000         | Micronesia, V6MP/Cross R/Pohnpei | 4755 as                        |  |
| 2300 0000         | New Zealand, R New Zealand Intl  | 15720pa                        |  |
| 2300 0000 DRM     | New Zealand, R New Zealand Intl  | 17675pa                        |  |
| 2300 0000         | Russia, Voice of Russia          | 9665va 9800va                  |  |
| 2300 0000         | UK, BBC World Service            | 3915as 6195as                  |  |
|                   | 7490as 9580as 9740as 9890as      |                                |  |
|                   | 11850as 12010as                  |                                |  |
| 2300 0000         | USA, Amer Forces Network/AFRTS   | 4319usb                        |  |
|                   | 5446usb 5765usb 7811usb          | 12133usb                       |  |
|                   | 12759usb 13362usb                |                                |  |
| 2300 0000         | USA, BBG/Voice of America        | 5895as                         |  |
|                   | 5910as 7460as 7555as 7575as      | 9570as 11840as 12150as 15340as |  |
| 2300 0000         | USA, FBN/WTJC Newport NC         | 9370na                         |  |
| 2300 0000         | USA, WBCQ Monticello ME7490am    | 9330am                         |  |
| 2300 0000 Sat/Sun | USA, WBCQ Monticello ME5110am    |                                |  |
| 2300 0000         | USA, WEWN/EWTN Irondale AL       | 15610me                        |  |
| 2300 0000         | USA, WHRI Cypress Creek SC       | 13620na                        |  |
|                   | 17510va                          |                                |  |
| 2300 0000 Sun     | USA, WHRI Cypress Creek SC       | 11775va                        |  |
| 2300 0000 mtwhfs  | USA, WHRI Cypress Creek SC       | 7315ca                         |  |
| 2300 0000         | USA, WINB Red Lion PA            | 9265am                         |  |
| 2300 0000         | USA, WTWW Lebanon TN             | 9479va                         |  |
| 2300 0000         | USA, WWCR Nashville TN           | 6875eu 9350af                  |  |
|                   | 9980af 13845eu                   |                                |  |
| 2300 0000         | USA, WWRB Manchester TN          | 5050na                         |  |
| 2300 0000         | USA, WYFR/Family R Worldwide     | 15255ca                        |  |
|                   | 11580sa                          |                                |  |
| 2300 0000         | Zambia, Christian Voice          | 4965af                         |  |
| 2300 2330         | Australia, ABC/R Australia       | 15240as                        |  |
| 2330 0000         | Australia, ABC/R Australia       | 17750as                        |  |
| 2330 0000         | Vietnam, VO Vietnam/Overseas Svc | 9840as                         |  |
|                   | 12020as                          |                                |  |





# MTXTRA

## Shortwave Broadcast Guide

### CHINESE/SPANISH

The following language schedule is extracted from our new MTXtra Shortwave Broadcast Guide pdf which is a free download to all MTXpress subscribers. This new online Shortwave Broadcast Guide has more than 9,100 station entries that include all languages being broadcasts via shortwave radio worldwide, sorted by time and updated monthly.

#### 1200 UTC - 8AM EDT / 7AM CDT / 5AM PDT

|               |                                     |   |
|---------------|-------------------------------------|---|
| 1200 1230     | Australia, HCJB Global Australia    | 15400as   |
| 1200 1230     | Clandestine, VO Tibet               | 15443as   |
| 1200 1230     | Guam, KTWR/TWR Asia                 | 9910as  |
| 1200 1230     | Japan, R Japan NHK World            | 6090as  |
| 1200 1230     | South Korea, KBS World R            | 6095as 9770as   |
| 1200 1230     | Taiwan, R Taiwan Intl               | 6105as 11915as  |
| 1200 1230     | Vietnam, VO Vietnam/Overseas Svc    | 7220as 12000as  |
| 1200 1257     | Iran, VO Islamic Rep of Iran        | 17610as 17670as 21500as 21650as   |
| 1200 1300     | China, China Huayi BC               | 6185do  |
| 1200 1300     | China, China R International        | 9570na 11850na  |
| 1200 1300     | China, China R International        | 7390as 7440as 9540as 9855as 11640as 11790va 13610as 13755as 13810va 15110me 17650eu |
| 1200 1300     | China, CNR/VO Pujiang               | 3280do 4950do 5075do  |
| 1200 1300     | China, CNR/VO Shenzhou/CNR6         | 6165do 9170do   |
| 1200 1300     | China, CNR/VO Zhonghua/CNR5         | 5925do 9410do   |
| 1200 1300     | China, Gannan PBS                   | 3990do 5970do   |
| 1200 1300     | China, Haixa zhi Sheng/VO Strait    | 6115do  |
| 1200 1300     | China, Nei Menggu PBS               | 7420do 9520do   |
| 1200 1300     | China, Sichuan PBS2                 | 6060do 7225do   |
| 1200 1300     | China, Tibet PBS                    | 4820do 5935do 6050do 7240do 7450do  |
| 1200 1300     | China, Xinjiang PBS                 | 3950do 5060do 5960do 7310do   |
| 1200 1300     | China, Yunnan PBS/Minority Svc      | 7210do  |
| 1200 1300     | Clandestine, Sound of Hope R Intl   | 7280as 11970as 12980as 13270as 13350as 13880as 14700as 14950as 16100as              |
| 1200 1300     | Guam, KTWR/TWR Asia                 | 9975as  |
| 1200 1300     | India, All India R/External Svc     | 11840as 15795as 17705as   |
| 1200 1300     | Indonesia, AWR Asia/Pacific         | 9800as 15490as  |
| 1200 1300     | Pakistan, PBC/R Pakistan            | 15700as 17725as   |
| 1200 1300     | Philippines, FEBC Philippines       | 9400as 9430as   |
| 1200 1300     | Russia, Voice of Russia             | 6075as  |
| 1200 1300     | Taiwan, R Taiwan Intl               | 9465as  |
| 1200 1300     | Taiwan, R Taiwan Intl               | 6085as 6150as 7385as 9665as 9680as 9780as 11710as                                   |
| 1200 1300     | USA, BBG/Voice of America           | 6110as 9840as 11785as 11825as 11990as 12040as 15115as 15250as                       |
| 1225 1300     | Vatican City State, Vatican R9900as | 11890as 17590as   |
| 1230 1240 Sat | Vatican City State, Vatican R9900as | 11890as 17590as   |
| 1230 1300     | Clandestine, Sound of Hope R Intl   | 9375as  |

#### 1300 UTC - 9AM EDT / 8AM CDT / 6AM PDT

|           |                                     |                         |
|-----------|-------------------------------------|-------------------------|
| 1300 1315 | India, All India R/External Svc     | 11840as 15795as 17705as |
| 1300 1315 | Vatican City State, Vatican R9900as | 11890as 17590as         |
| 1300 1326 | Romania, R Romania Intl             | 15435as 17850as         |
| 1300 1330 | Clandestine, Sound of Hope R Intl   | 15750as                 |

|                  |                                   |  |
|------------------|-----------------------------------|--|
| 1300 1330        | Clandestine, VO Tibet             | 15497as  |
| 1300 1330 mtwhf  | Indonesia, AWR Asia/Pacific       | 15320as  |
| 1300 1330        | Japan, R Japan NHK World          | 6190as   |
| 1300 1330        | Vietnam, VO Vietnam/Overseas Svc  | 7220as 12000as   |
| 1300 1357        | North Korea, Voice of Korea       | 11735as 13650as  |
| 1300 1400        | Australia, ABC/R Australia        | 9475as 9965as 11660as 11760as  |
| 1300 1400        | China, China Huayi BC             | 6185do   |
| 1300 1400        | China, China R International      | 7205as 7215as 7440as 9540as 9855as 13650me 13670eu                             |
| 1300 1400        | China, CNR/VO Pujiang             | 3280do 4950do 5075do   |
| 1300 1400        | China, CNR/VO Shenzhou/CNR6       | 6165do 9170do  |
| 1300 1400        | China, CNR/VO Zhonghua/CNR5       | 5925do 9410do  |
| 1300 1400        | China, Gannan PBS                 | 3990do 5970do  |
| 1300 1400        | China, Nei Menggu PBS             | 7420do 9520do  |
| 1300 1400        | China, Sichuan PBS2               | 6060do 7225do  |
| 1300 1400        | China, Tibet PBS                  | 4820do 5935do 6050do 7240do 7450do   |
| 1300 1400        | China, Xinjiang PBS               | 3950do 5060do 5960do 7310do  |
| 1300 1400        | China, Yunnan PBS/Minority Svc    | 7210do   |
| 1300 1400        | China, Yunnan PBS/VO Shangri-La   | 6035do   |
| 1300 1400        | Clandestine, Minghui R            | 6030as   |
| 1300 1400        | Clandestine, Sound of Hope R Intl | 7310as 11970as 12980as 13130as 13350as 13880as 14950as 15900as 16100as 17770af |
| 1300 1400        | Germany, Deutsche Welle           | 11965as  |
| 1300 1400 smtwhf | Guam, KTWR/TWR Asia               | 9975as   |
| 1300 1400        | Philippines, FEBC Philippines     | 9400as 9430as  |
| 1300 1400        | Russia, Voice of Russia           | 9560as   |
| 1300 1400        | South Korea, KBS World R          | 7275as   |
| 1300 1400        | Taiwan, R Taiwan Intl             | 11625as  |
| 1300 1400        | Taiwan, R Taiwan Intl             | 6085as 6150as 7385as 7445as 9680as 9780as 15265as                              |
| 1300 1400        | USA, BBG/Voice of America         | 7365as 9355as  |
| 1300 1400        | USA, BBG/Voice of America         | 6110as 9845as 11785as 11805as 11990as 12040as 15115as 15250as                  |
| 1315 1330        | Thailand, R Thailand World Svc    | 9795as   |
| 1330 1400        | Clandestine, Sound of Hope R Intl | 11550as  |
| 1330 1400        | Clandestine, VO Tibet             | 15487as  |
| 1330 1400        | Indonesia, AWR Asia/Pacific       | 15320as  |

#### 1400 UTC - 10AM EDT / 9AM CDT / 7AM PDT

|                  |                                   |   |
|------------------|-----------------------------------|---|
| 1400 1430        | Australia, ABC/R Australia        | 9475as 9965as 11660as 11760as                                     |
| 1400 1430        | Clandestine, Sound of Hope R Intl | 9995as 11970as 12980as  |
| 1400 1430 mtwhf  | Guam, KTWR/TWR Asia               | 9955as  |
| 1400 1445 smtwhf | Guam, KTWR/TWR Asia               | 9975as  |
| 1400 1500        | China, China Huayi BC             | 6185do  |
| 1400 1500        | China, China R International      | 9655as 11650as  |
| 1400 1500        | China, China R International      | 6040as 7210as 7235as 7400as 9430me 9730as 11610as 11785eu 15220na |
| 1400 1500        | China, CNR/VO Pujiang             | 3280do 4950do 5075do  |

|                |                                   |         |         |
|----------------|-----------------------------------|---------|---------|
| 1400 1500      | China, CNR/VO Shenzhou/CNR6       | 6165do  |         |
|                | 9170do                            |         |         |
| 1400 1500      | China, CNR/VO Zhonghua/CNR5       | 5925do  |         |
|                | 9410do                            |         |         |
| 1400 1500      | China, Nei Menggu PBS             | 7420do  | 9520do  |
| 1400 1500      | China, Sichuan PBS2               | 6060do  | 7225do  |
| 1400 1500      | China, Tibet PBS                  | 4820do  | 5935do  |
|                | 7240do                            | 7450do  | 6050do  |
| 1400 1500      | China, Xinjiang PBS               | 3950do  | 5060do  |
|                | 5960do                            | 7310do  |         |
| 1400 1500      | China, Yunnan PBS/Minority Svc    | 7210do  |         |
| 1400 1500      | Clandestine, Sound of Hope R Intl | 9450as  |         |
|                | 11970as                           | 12980as | 13130as |
|                | 13880as                           | 14950as | 15900as |
|                |                                   | 15900as | 16100as |
| 1400 1500      | Clandestine, VO China             | 7270as  |         |
| 1400 1500      | Indonesia, AWR Asia/Pacific       |         | 13575as |
|                | 15320as                           |         |         |
| 1400 1500      | Philippines, FEBC Philippines     |         | 9345as  |
|                | 9430as                            |         |         |
| 1400 1500      | Taiwan, R Taiwan Intl             | 6075as  | 6085as  |
|                | 6145as                            | 7385as  | 7445as  |
|                |                                   | 7445as  | 9680as  |
| 1400 1500      | USA, BBG/R Free Asia              | 12135as |         |
| 1400 1500      | USA, BBG/Voice of America         |         | 7365as  |
|                | 9355as                            |         |         |
| 1400 1500      | USA, BBG/Voice of America         |         | 6110as  |
|                | 9845as                            | 11615as | 11785as |
|                | 15115as                           | 15250as | 11805as |
| 1405 1420 twhf | Canada, Bible Voice Broadcasting  |         | 15270as |
| 1430 1500      | Clandestine, Sound of Hope R Intl |         | 15780as |
| 1430 1500      | Clandestine, Sound of Hope R Intl |         | 15780as |
| 1430 1500      | Japan, R Japan NHK World          |         | 6190as  |
| 1430 1500      | Mongolia, Voice of Mongolia       |         | 12015as |
| 1430 1500      | USA, BBG/R Free Asia              | 7280as  | 9605as  |

**1500 UTC - 11AM EDT / 10AM CDT / 8AM PDT**

|                   |                                   |         |         |
|-------------------|-----------------------------------|---------|---------|
| 1500 1515         | China, Sichuan PBS2               | 6060do  | 7225do  |
| 1500 1530         | Taiwan, R Taiwan Intl             | 11605as |         |
| 1500 1600         | China, China Huayi BC             | 6185do  |         |
| 1500 1600         | China, China R International      |         | 5910as  |
|                   | 7255as                            | 7265as  | 9455as  |
|                   | 13680eu                           | 13755eu | 9560as  |
| 1500 1600         | China, CNR/VO Pujiang             | 3280do  | 4950do  |
|                   | 5075do                            |         |         |
| 1500 1600         | China, CNR/VO Shenzhou/CNR6       | 6165do  |         |
|                   | 9170do                            |         |         |
| 1500 1600         | China, CNR/VO Zhonghua/CNR5       | 5925do  |         |
|                   | 9410do                            |         |         |
| 1500 1600         | China, Nei Menggu PBS             | 7420do  | 9520do  |
| 1500 1600         | China, Tibet PBS                  | 4820do  | 5935do  |
|                   | 7240do                            | 7450do  | 6050do  |
| 1500 1600         | China, Xinjiang PBS               | 3950do  | 5060do  |
|                   | 5960do                            | 7310do  |         |
| 1500 1600         | Clandestine, Sound of Hope R Intl | 7550as  |         |
|                   | 9450as                            | 11970as | 12980as |
|                   | 13350as                           | 13850as | 14950as |
|                   |                                   | 14950as | 16100as |
| 1500 1600         | Guam, KTWR/TWR Asia               | 12105as |         |
| 1500 1600         | Philippines, FEBC Philippines     |         | 9345as  |
|                   | 9430as                            |         |         |
| 1500 1600 Sat/Sun | Taiwan, R Taiwan Intl             | 7380as  |         |
| 1500 1600         | Taiwan, R Taiwan Intl             | 6075as  | 6145as  |
|                   | 7365as                            | 7380as  | 7385as  |
|                   |                                   | 7385as  | 9680as  |
|                   |                                   |         | 11665as |

**1600 UTC - 12PM EDT / 11AM CDT / 9AM PDT**

|           |                                   |         |         |
|-----------|-----------------------------------|---------|---------|
| 1600 1605 | China, CNR/VO Shenzhou/CNR6       | 6165do  |         |
|           | 9170do                            |         |         |
| 1600 1630 | Clandestine, Sound of Hope R Intl |         | 7550as  |
| 1600 1630 | Japan, R Japan NHK World          |         | 9720as  |
| 1600 1700 | China, CNR/VO Zhonghua/CNR5       | 5925do  |         |
|           | 9410do                            |         |         |
| 1600 1700 | China, Tibet PBS                  | 4820do  | 5935do  |
|           | 7240do                            | 7450do  | 6050do  |
| 1600 1700 | China, Xinjiang PBS               | 3950do  | 4850do  |
|           | 5960do                            | 7310do  |         |
| 1600 1700 | Clandestine, Sound of Hope R Intl |         | 11970as |
|           | 12980as                           | 13130as | 13350as |
|           | 14700as                           | 15900as | 15940as |
|           |                                   | 15940as | 16100as |
| 1600 1700 | Philippines, FEBC Philippines     |         | 9345as  |
|           | 9430as                            |         |         |
| 1600 1700 | Taiwan, R Taiwan Intl             | 6075as  | 6145as  |

|           |                                |        |        |         |
|-----------|--------------------------------|--------|--------|---------|
|           | 7365as                         | 7385as | 9680as | 11665as |
| 1605 1700 | China, Nei Menggu PBS          |        | 7420do | 9520do  |
| 1630 1645 | Serbia, International R Serbia |        |        | 9635eu  |

**1700 UTC - 1PM EDT / 12PM CDT / 10AM PDT**

|           |                              |        |         |
|-----------|------------------------------|--------|---------|
| 1700 1705 | China, CNR/VO Zhonghua/CNR5  | 5925do |         |
|           | 9410do                       |        |         |
| 1700 1800 | China, China R International |        | 9435af  |
|           | 9770af                       |        |         |
| 1700 1800 | China, Nei Menggu PBS        | 7420do | 9520do  |
| 1700 1800 | China, Tibet PBS             | 4820do | 5935do  |
|           | 7240do                       | 7450do | 6050do  |
| 1700 1800 | China, Xinjiang PBS          | 3950do | 4850do  |
|           | 5960do                       | 7310do |         |
| 1700 1800 | Taiwan, R Taiwan Intl        | 6075as | 6145as  |
| 1730 1800 | China, China R International |        | 7315me  |
|           | 7385me                       | 9685eu | 9745va  |
|           |                              |        | 11660eu |

**1800 UTC - 2PM EDT / 1PM CDT / 11AM PDT**

|           |                              |        |        |         |
|-----------|------------------------------|--------|--------|---------|
| 1800 1805 | China, Tibet PBS             | 4820do | 5935do | 6050do  |
|           | 7240do                       | 7450do |        |         |
| 1800 1830 | China, China R International |        |        | 7315me  |
|           | 7385me                       | 9685eu | 9745va | 11660eu |
| 1800 1900 | China, China R International |        |        | 11895eu |
|           | 13700eu                      |        |        |         |
| 1800 1900 | China, Nei Menggu PBS        | 7420do | 9520do |         |
| 1800 1900 | China, Tibet PBS             | 4820do | 5935do | 6050do  |
|           | 7240do                       | 7450do |        |         |

**1900 UTC - 3PM EDT / 2PM CDT / 12PM PDT**

|           |                              |        |        |
|-----------|------------------------------|--------|--------|
| 1900 2000 | China, China R International |        | 7235eu |
|           | 11895eu                      |        |        |
| 1900 2000 | China, Nei Menggu PBS        | 7420do | 9520do |
| 1900 2000 | China, Tibet PBS             | 4820do | 5935do |
|           | 7240do                       | 7450do | 6050do |

**2000 UTC - 4PM EDT / 3PM CDT / 1PM PDT**

|           |                                   |         |         |
|-----------|-----------------------------------|---------|---------|
| 2000 2100 | China, China R International      |         | 7245eu  |
|           | 7335eu                            | 7405af  | 7440eu  |
| 2000 2100 | China, Nei Menggu PBS             | 7420do  | 9520do  |
| 2000 2100 | China, Tibet PBS                  | 4820do  | 5935do  |
|           | 7240do                            | 7450do  | 6050do  |
| 2000 2100 | Clandestine, Sound of Hope R Intl |         | 11970as |
|           | 12980as                           | 13130as | 13350as |
|           | 14700as                           | 15900as | 15940as |
|           |                                   | 15940as | 16100as |
| 2055 2100 | China, CNR/VO Zhonghua/CNR5       |         | 5925do  |
|           | 7620do                            | 9665do  |         |

**2100 UTC - 5PM EDT / 4PM CDT / 2PM PDT**

|                  |                                   |         |         |
|------------------|-----------------------------------|---------|---------|
| 2100 2157        | North Korea, Voice of Korea       |         | 7235as  |
|                  | 9345as                            | 9975as  | 11535as |
| 2100 2200        | China, CNR/VO Zhonghua/CNR5       |         | 5925do  |
|                  | 7620do                            | 9665do  |         |
| 2100 2200        | China, Nei Menggu PBS             | 7420do  | 9520do  |
| 2100 2200        | China, Tibet PBS                  | 4820do  | 5935do  |
|                  | 7240do                            | 7450do  | 6050do  |
| 2100 2200        | Clandestine, Sound of Hope R Intl |         | 11970as |
|                  | 12980as                           | 13130as | 13350as |
|                  | 14700as                           | 15900as | 15940as |
|                  |                                   | 15940as | 16100as |
| 2100 2200 Sat    | Indonesia, AWR Asia/Pacific       |         | 11750as |
| 2100 2200 Sun    | Indonesia, AWR Asia/Pacific       |         | 15420as |
| 2100 2200 mtwhfs | Indonesia, AWR Asia/Pacific       |         | 11750as |
|                  | 15420as                           |         |         |
| 2130 2200        | China, Hulun Buir PBS             | 3900do  |         |
| 2155 2200        | China, CNR/VO Shenzhou/CNR6       |         | 6165do  |
|                  | 9170do                            |         |         |
| 2155 2200        | China, Sichuan PBS2               | 6060do  | 7225do  |

**2200 UTC - 6PM EDT / 5PM CDT / 3PM PDT**

|           |                                  |  |         |
|-----------|----------------------------------|--|---------|
| 2200 2230 | Australia, HCJB Global Australia |  | 15525as |
| 2200 2230 | Vietnam, VO Vietnam/Overseas Svc |  | 7220as  |
|           | 12000as                          |  |         |



|           |                                     |                 |
|-----------|-------------------------------------|-----------------|
| 2200 2245 | Vatican City State, Vatican R9600as | 12035as         |
|           | 15460as                             |                 |
| 2200 2257 | North Korea, Voice of Korea         | 7235as          |
|           | 9345as 9975as 11535as               |                 |
| 2200 2300 | China, China R International        | 5975af          |
|           | 6100as 6140af 7215as 7265af         |                 |
|           | 7325as 7395as 7430af 9460pa         |                 |
|           | 9675as                              |                 |
| 2200 2300 | China, CNR/VO Shenzhou/CNR6         | 6165do          |
|           | 9170do                              |                 |
| 2200 2300 | China, CNR/VO Zhonghua/CNR5         | 5925do          |
|           | 7620do 9665do                       |                 |
| 2200 2300 | China, Hulun Buir PBS               | 3900do          |
| 2200 2300 | China, Nei Menggu PBS               | 7420do 9520do   |
| 2200 2300 | China, Sichuan PBS2                 | 6060do 7225do   |
| 2200 2300 | China, Tibet PBS 4820do             | 5935do 6050do   |
|           | 7240do 7450do                       |                 |
| 2200 2300 | Clandestine, Sound of Hope R Intl   | 11970as         |
|           | 12980as 13130as 13350as 13850as     |                 |
|           | 14700as 15900as 15940as 16100as     |                 |
| 2200 2300 | Indonesia, AWR Asia/Pacific         | 12120as         |
|           | 15215as                             |                 |
| 2200 2300 | South Korea, KBS World R            | 7275as          |
| 2200 2300 | Taiwan, R Taiwan Intl               | 6105as 6150as   |
|           | 11635as 11710as 11885as             |                 |
| 2200 2300 | USA, BBG/R Free Asia                | 11785as 15320as |
| 2200 2300 | USA, BBG/Voice of America           | 6135as          |
|           | 7205as 9510as 9845as 11925as        |                 |
|           | 13660as                             |                 |
| 2220 2300 | China, Gannan PBS                   | 3990do 5970do   |
| 2230 2250 | Japan, R Japan NHK World            | 9560as          |
| 2230 2300 | Australia, HCJB Global Australia    | 15525as         |
| 2230 2300 | China, China Huayi BC               | 6185do          |
| 2230 2300 | China, China R International        | 7295af          |
|           | 7370eu 9865eu 11900as 15505af       |                 |
| 2230 2300 | China, Haixa zhi Sheng/VO Strait    | 6115do          |
| 2230 2300 | China, Haixa zhi Sheng/VO Strait    | 4940do          |
|           | 7280do                              |                 |
| 2230 2300 | Philippines, FEBC Philippines       | 9405as          |
| 2230 2300 | Vietnam, VO Vietnam/Overseas Svc    | 9840as          |
|           | 12020as                             |                 |
| 2235 2300 | China, CNR/Fujian                   | 5040do          |
| 2255 2300 | China, Yunnan PBS/Minority Svc      | 7210do          |

### 2300 UTC - 7PM EDT / 6PM CDT / 4PM PDT

|                   |                                   |                 |
|-------------------|-----------------------------------|-----------------|
| 2300 0000         | Australia, HCJB Global Australia  | 15525as         |
| 2300 0000         | China, China Huayi BC             | 6185do          |
| 2300 0000         | China, China R International      | 6140as          |
|                   | 7325as 9460as 11945as 15100as     |                 |
| 2300 0000         | China, CNR/VO Shenzhou/CNR6       | 6165do          |
|                   | 9170do                            |                 |
| 2300 0000         | China, CNR/VO Zhonghua/CNR5       | 5925do          |
|                   | 7620do 9665do                     |                 |
| 2300 0000         | China, Gannan PBS                 | 3990do 5970do   |
| 2300 0000         | China, Haixa zhi Sheng/VO Strait  | 6115do          |
| 2300 0000         | China, Haixa zhi Sheng/VO Strait  | 4940do          |
|                   | 7280do                            |                 |
| 2300 0000         | China, Hulun Buir PBS             | 3900do          |
| 2300 0000         | China, Nei Menggu PBS             | 7420do 9520do   |
| 2300 0000         | China, Sichuan PBS2               | 6060do 7225do   |
| 2300 0000         | China, Tibet PBS 4820do           | 5935do 6050do   |
|                   | 7240do 7450do                     |                 |
| 2300 0000 Sat/Sun | China, VO Guangxi/Beibu Bay R     | 5050do          |
|                   | 9820do                            |                 |
| 2300 0000         | China, Yunnan PBS/Minority Svc    | 7210do          |
| 2300 0000         | Clandestine, Sound of Hope R Intl | 11970as         |
|                   | 12980as 13130as 13350as 13850as   |                 |
|                   | 14700as 15900as 15940as 16100as   |                 |
| 2300 0000         | Clandestine, VO China             | 7270as          |
| 2300 0000         | France, R France International    | 9955as          |
|                   | 11665as                           |                 |
| 2300 0000         | Indonesia, AWR Asia/Pacific       | 15370as         |
| 2300 0000         | Philippines, FEBC Philippines     | 12070as         |
| 2300 0000         | South Korea, KBS World R          | 9805as          |
| 2300 0000         | Taiwan, R Taiwan Intl             | 6105as 6150as   |
|                   | 9660as 9685as 11635as 11710as     |                 |
|                   | 11885as                           |                 |
| 2300 2325         | China, CNR/Fujian                 | 5040do          |
| 2330 0000         | China, Xinjiang PBS               | 3950do 5060do   |
|                   | 5960do 7310do                     |                 |
| 2330 0000         | Iran, VO Islamic Rep of Iran      | 13670as 13715as |
|                   | 15470as                           |                 |

### MT SPANISH LANGUAGE SHORTWAVE GUIDE

#### 0000 UTC - 8PM EDT / 7PM CDT / 5PM PDT

|                   |                                       |                    |
|-------------------|---------------------------------------|--------------------|
| 0000 0030         | Peru, Ondas del Huallaga              | 3330do             |
| 0000 0030         | Peru, R San Antonio                   | 3375do 4940do      |
| 0000 0100 Sat/Sun | Argentina, RAE                        | 6060am 15345eu     |
| 0000 0100         | Bolivia, R Eco                        | 4409do             |
| 0000 0100         | Bolivia, R Em Camargo                 | 3390do             |
| 0000 0100 twhfa   | Bolivia, R Fides                      | 6155do             |
| 0000 0100         | Bolivia, R Illimani/R Patria Nueva    | 6025do             |
| 0000 0100         | Bolivia, R Logos                      | 4865do             |
| 0000 0100         | Bolivia, R Mosoj Chaski               | 3310do             |
| 0000 0100         | Bolivia, R Panamericana               | 5765do 6105do      |
| 0000 0100         | Bolivia, R Pio XII                    | 5952do 5955af      |
| 0000 0100         | Bolivia, R San Jose                   | 5580do             |
| 0000 0100         | Bolivia, R San Miguel                 | 4699do             |
| 0000 0100         | Bolivia, R Santa Cruz                 | 6135do             |
| 0000 0100         | Bolivia, R Tacana                     | 4782do             |
| 0000 0100         | Bolivia, R Virgen de los Remedios     | 4111do             |
| 0000 0100         | Bolivia, Yatun Ayllu Yura/R Yura      | 4717do             |
|                   | 4715af                                |                    |
| 0000 0100         | Chile, CVC La Voz                     | 9780sa 11665sa     |
| 0000 0100         | China, China R International          | 5990ca             |
|                   | 9590va 9800va 15120sa                 |                    |
| 0000 0100 Sat/Sun | Clandestine, R Republica              | 5954ca             |
| 0000 0100         | Colombia, La Voz de tu Conciencia     | 6010do             |
| 0000 0100         | Colombia, La Voz del Guaviare         | 6035do             |
| 0000 0100         | Colombia, R Alcaravan                 | 5910do             |
| 0000 0100         | Colombia, Salem Stereo                | 14950do            |
| 0000 0100         | Cuba, R Havana Cuba                   | 6060na 6120ca      |
|                   | 9810ca 11680sa 11760am 15230sa        |                    |
|                   | 17705sa                               |                    |
| 0000 0100         | Cuba, R Rebelde                       | 5025na             |
| 0000 0100         | Dominican Rep, R Amanecer Intl        | 6025do             |
| 0000 0100         | Ecuador, La Voz del Napo              | 3280do             |
| 0000 0100         | Ecuador, R El Buen Pastor             | 4815do             |
| 0000 0100         | Ecuador, R Quito                      | 4919do             |
| 0000 0100         | Honduras, HRMI/R Misiones Intl        | 3340do             |
| 0000 0100         | Mexico, R Educacion                   | 6185do             |
| 0000 0100         | Mexico, R Mil Onda Corta              | 6010do             |
| 0000 0100         | Mexico, R Transcontinental de America | 4800do             |
| 0000 0100         | Mexico, R Universidad                 | 6045do             |
| 0000 0100         | Peru, La Voz de la Selva              | 4824do             |
| 0000 0100         | Peru, La Voz de las Huarinjas         | 5059do             |
| 0000 0100         | Peru, R Altura                        | 5014do             |
| 0000 0100         | Peru, R Ancash                        | 4990do 4992af      |
| 0000 0100         | Peru, R Andina                        | 4995do             |
| 0000 0100         | Peru, R Bethel                        | 5921do             |
| 0000 0100         | Peru, R Bolivar                       | 5460do             |
| 0000 0100         | Peru, R Cultural Amauta               | 4955do             |
| 0000 0100         | Peru, R Cusco                         | 4780do             |
| 0000 0100         | Peru, R Frecuencia Popular            | 5485do             |
| 0000 0100         | Peru, R Genesis                       | 4850do             |
| 0000 0100         | Peru, R Horizonte                     | 5020do             |
| 0000 0100         | Peru, R Huanta                        | 2000 4747do 4755af |
| 0000 0100         | Peru, R Madre de Dios                 | 4950do             |
| 0000 0100         | Peru, R Manantial                     | 4987do             |
| 0000 0100         | Peru, R Maranon                       | 4835do             |
| 0000 0100         | Peru, R Melodia                       | 5939do             |
| 0000 0100         | Peru, R Municipal                     | 3173do             |
| 0000 0100         | Peru, R Ondas del Sur Oriente         | 5120do             |
| 0000 0100         | Peru, R Quillabamba                   | 5025do             |
| 0000 0100         | Peru, R Reina de la Selva             | 5487do             |
| 0000 0100         | Peru, R Sicuani                       | 4826do             |
| 0000 0100         | Peru, R Tarma                         | 4775do             |
| 0000 0100         | Peru, R Tawantinsuyo                  | 6174do             |
| 0000 0100         | Peru, R Union                         | 6115do             |
| 0000 0100         | Peru, R Victoria                      | 6020do 9720do      |
| 0000 0100         | Peru, R Virgen del Carmen             | 4887do 4895af      |
| 0000 0100         | Peru, R Vision                        | 4790do             |
| 0000 0100         | Spain, R Exterior de Espana           | 9535ca 9620sa      |
|                   | 15160sa                               |                    |
| 0000 0100 DRM     | Spain, R Exterior de Espana           | 9630na 11815sa     |
| 0000 0100         | USA, BBG/R Marti                      | 6030ca 7365ca      |
|                   | 11775ca                               |                    |
| 0000 0100         | USA, BBG/Voice of America             | 5890ca             |
|                   | 12000sa                               |                    |
| 0000 0100 twhfa   | USA, BBG/Voice of America             | 9885ca             |
| 0000 0100         | USA, WEWN/EWTN Irontdale AL           | 5810ca             |
|                   | 11870sa                               |                    |

0000 0100 USA, WYFR/Family R Worldwide 5985sa  
 11530sa 15355sa 15440sa  
 0030 0045 m USA, FBN/WTJC Newport NC 9370na  
 0030 0045 m USA, WHRI Cypress Creek SC 7315ca  
 0030 0100 Iran, VO Islamic Rep of Iran 9860sa 11760sa  
 0045 0100 Egypt, R Cairo 9720am 13620am 13855am

**0100 UTC - 9PM EDT / 8PM CDT / 6PM PDT**

0100 0130 Peru, R Bolivar 5460do  
 0100 0145 USA, WYFR/Family R Worldwide 11855ca  
 17725sa  
 0100 0155 Turkey, Voice of Turkey 9770va 9870va  
 0100 0200 Sat/Sun Argentina, RAE 6060am 15345eu  
 0100 0200 Bolivia, R Eco 4409do  
 0100 0200 Bolivia, R Em Camargo 3390do  
 0100 0200 twhfa Bolivia, R Fides 6155do  
 0100 0200 Bolivia, R Illimani/R Patria Nueva 6025do  
 0100 0200 Bolivia, R Panamericana 5765do 6105do  
 0100 0200 Bolivia, R Pio XII 5952do 5955al  
 0100 0200 Bolivia, R San Jose 5580do  
 0100 0200 Bolivia, R San Miguel 4699do  
 0100 0200 Bolivia, R Santa Cruz 6135do  
 0100 0200 Bolivia, R Tacana 4782do  
 0100 0200 Bolivia, R Virgen de los Remedios 4111do  
 0100 0200 Bolivia, Yatun Ayllu Yura/R Yura 4717do  
 4715al  
 0100 0200 China, China R International 9595sa  
 9710sa  
 0100 0200 Sat/Sun Clandestine, R Republica 5954ca  
 0100 0200 twhfa Clandestine, R Republica 5954ca  
 0100 0200 Clandestine, R Republica 9490ca  
 0100 0200 Colombia, La Voz de tu Conciencia 6010do  
 0100 0200 Colombia, La Voz del Guaviare 6035do  
 0100 0200 Colombia, R Alcaravan 5910do  
 0100 0200 Colombia, Salem Stereo 14950do  
 0100 0200 Cuba, R Havana Cuba 5040va 6060na  
 9810ca 11680sa 11760am 15230sa  
 17705sa  
 0100 0200 Cuba, R Rebelde 5025na  
 0100 0200 Dominican Rep, R Amanecer Intl 6025do  
 0100 0200 Ecuador, La Voz del Napo 3280do  
 0100 0200 Ecuador, R El Buen Pastor 4815do  
 0100 0200 Ecuador, R Quito 4919do  
 0100 0200 Egypt, R Cairo 9315am 13620am 13855am  
 0100 0200 Honduras, HRMI/ R Misiones Intl 3340do  
 0100 0200 Iran, VO Islamic Rep of Iran 9860sa 11760sa  
 0100 0200 Mexico, R Educacion 6185do  
 0100 0200 Mexico, R Mil Onda Corta 6010do  
 0100 0200 Mexico, R Transcontinental de America  
 4800do  
 0100 0200 Mexico, R Universidad 6045do  
 0100 0200 Peru, La Voz de las Huarinjas 5059do  
 0100 0200 Peru, R Altura 5014do  
 0100 0200 Peru, R Ancash 4990do 4992al  
 0100 0200 Peru, R Andina 4995do  
 0100 0200 Peru, R Cusco 4780do  
 0100 0200 Peru, R Frecuencia Popular 5485do  
 0100 0200 Peru, R Genesis 4850do  
 0100 0200 Peru, R Horizonte 5020do  
 0100 0200 Peru, R Madre de Dios 4950do  
 0100 0200 Peru, R Manantial 4987do  
 0100 0200 Peru, R Maranon 4835do  
 0100 0200 Peru, R Melodia 5939do  
 0100 0200 Peru, R Municipal 3173do  
 0100 0200 Peru, R Ondas del Sur Oriente 5120do  
 0100 0200 Peru, R Quillabamba 5025do  
 0100 0200 Peru, R Reina de la Selva 5487do  
 0100 0200 Peru, R Sicuani 4826do  
 0100 0200 Peru, R Tarma 4775do  
 0100 0200 Peru, R Tawantinsuyo 6174do  
 0100 0200 Peru, R Union 6115do  
 0100 0200 Peru, R Victoria 6020do 9720do  
 0100 0200 Peru, R Virgen del Carmen 4887do 4895al  
 0100 0200 Peru, R Vision 4790do  
 0100 0200 South Korea, KBS World R 11810sa

0100 0200 Spain, R Exterior de Espana 5995sa 6055na  
 9535ca 9620sa 15160sa  
 0100 0200 DRM Spain, R Exterior de Espana 9630na  
 0100 0200 USA, BBG/R Marti 6030ca 7365ca  
 11775ca  
 0100 0200 USA, WEWN/EWTN Irondale AL 5810ca  
 11870sa  
 0100 0200 USA, WYFR/Family R Worldwide 5985sa  
 7570ca 11580sa 11855ca 15255sa  
 15440sa 17725sa  
 0100 0200 Vatican City State, Vatican R 9610ca  
 0130 0200 mtwhf Ecuador, HCJB/LV de los Andes 6050sa

**0200 UTC - 10PM EDT / 9PM CDT / 7PM PDT**

0200 0227 Iran, VO Islamic Rep of Iran 9860sa 11760sa  
 0200 0230 Bolivia, R Pio XII 5952do 5955al  
 0200 0230 South Korea, KBS World R 9560na  
 0200 0230 USA, WRMI/R Prague relay 9955ca  
 0200 0230 Vatican City State, Vatican R 9610ca  
 0200 0256 Romania, R Romania Intl 9520ca 9645sa  
 11795sa 11945sa  
 0200 0300 Sat/Sun Argentina, RAE 6060am 15345eu  
 0200 0300 Bolivia, R Eco 4409do  
 0200 0300 Bolivia, R Em Camargo 3390do  
 0200 0300 fa Bolivia, R Fides 6155do  
 0200 0300 Bolivia, R Illimani/R Patria Nueva 6025do  
 0200 0300 Bolivia, R Panamericana 5765do 6105do  
 0200 0300 Bolivia, R San Miguel 4699do  
 0200 0300 Bolivia, R Tacana 4782do  
 0200 0300 China, China R International 9595sa  
 9710sa  
 0200 0300 Colombia, La Voz de tu Conciencia 6010do  
 0200 0300 Colombia, R Alcaravan 5910do  
 0200 0300 Colombia, Salem Stereo 14950do  
 0200 0300 Cuba, R Havana Cuba 5040va 6060na  
 6120ca 9810ca 11680sa 11760am  
 15230sa 17705sa  
 0200 0300 Cuba, R Rebelde 5025na  
 0200 0300 Dominican Rep, R Amanecer Intl 6025do  
 0200 0300 mtwhf Ecuador, HCJB/LV de los Andes 6050sa  
 0200 0300 Ecuador, La Voz del Napo 3280do  
 0200 0300 Ecuador, R El Buen Pastor 4815do  
 0200 0300 Ecuador, R Quito 4919do  
 0200 0300 Honduras, HRMI/ R Misiones Intl 3340do  
 0200 0300 Mexico, R Educacion 6185do  
 0200 0300 Mexico, R Mil Onda Corta 6010do  
 0200 0300 Mexico, R Transcontinental de America  
 4800do  
 0200 0300 Mexico, R Universidad 6045do  
 0200 0300 Peru, R Altura 5014do  
 0200 0300 Peru, R Maranon 4835do  
 0200 0300 Peru, R Ondas del Sur Oriente 5120do  
 0200 0300 Peru, R Reina de la Selva 5487do  
 0200 0300 Peru, R Sicuani 4826do  
 0200 0300 Peru, R Tarma 4775do  
 0200 0300 Peru, R Tawantinsuyo 6174do  
 0200 0300 Peru, R Union 6115do  
 0200 0300 Peru, R Victoria 6020do 9720do  
 0200 0300 Peru, R Virgen del Carmen 4887do 4895al  
 0200 0300 Peru, R Vision 4790do  
 0200 0300 Spain, R Exterior de Espana 3350ca 5995sa  
 6055na 6125ca 9535ca 9620sa  
 9630na  
 0200 0300 Taiwan, R Taiwan Intl 7570sa 11995sa  
 0200 0300 USA, BBG/R Marti 6030ca 7365ca  
 11775ca  
 0200 0300 USA, WEWN/EWTN Irondale AL 5810ca  
 11870sa  
 0200 0300 USA, WYFR/Family R Worldwide 9385sa  
 11580sa 11740sa 15255sa  
 0230 0300 Iran, VO Islamic Rep of Iran 9860sa  
 0230 0300 USA, WRMI/R Slovakia Intl relay 9955am



**0300 UTC - 11PM EDT / 10PM CDT / 8PM PDT**

|              |                                    |         |         |
|--------------|------------------------------------|---------|---------|
| 0300 0327    | Iran, VO Islamic Rep of Iran       | 9860sa  |         |
| 0300 0330    | Bolivia, R Eco                     | 4409do  |         |
| 0300 0330    | Bolivia, R San Miguel              | 4699do  |         |
| 0300 0330    | Vietnam, VO Vietnam/Overseas Svc   | 6175na  |         |
| 0300 0345    | USA, WYFR/Family R Worldwide       | 6875sa  |         |
| 0300 0355    | Ecuador, R El Buen Pastor          | 4815do  |         |
| 0300 0357    | North Korea, Korean Central BC Sta | 11735ca |         |
|              |                                    | 13760sa | 15180sa |
| 0300 0400 fa | Bolivia, R Fides                   | 6155do  |         |
| 0300 0400    | Bolivia, R Panamericana            | 5765do  | 6105do  |
| 0300 0400    | China, China R International       | 9560sa  |         |
| 0300 0400    | Colombia, La Voz de tu Conciencia  | 6010do  |         |
| 0300 0400    | Colombia, R Alcaravan              | 5910do  |         |
| 0300 0400    | Colombia, Salem Stereo             | 14950do |         |
| 0300 0400    | Cuba, R Havana Cuba                | 5040va  | 6060na  |
|              |                                    | 6120ca  | 9810ca  |
|              |                                    | 15230sa | 17705sa |
| 0300 0400    | Cuba, R Rebelde                    | 5025na  |         |
| 0300 0400    | Ecuador, HCJB/LV de los Andes      | 6050sa  |         |

|                   |                                       |         |        |
|-------------------|---------------------------------------|---------|--------|
| 0300 0400         | Honduras, HRMI/ R Misiones Intl       | 3340do  |        |
| 0300 0400         | Mexico, R Educacion                   | 6185do  |        |
| 0300 0400         | Mexico, R Mil Onda Corta              | 6010do  |        |
| 0300 0400         | Mexico, R Transcontinental de America | 4800do  |        |
| 0300 0400         | Mexico, R Universidad                 | 6045do  |        |
| 0300 0400 DRM     | North Korea, Voice of Korea           | 3560as  |        |
| 0300 0400         | Peru, R Tarma                         | 4775do  |        |
| 0300 0400         | Peru, R Tawantinsuyo                  | 6174do  |        |
| 0300 0400         | Peru, R Union                         | 6115do  |        |
| 0300 0400         | Peru, R Victoria                      | 6020do  | 9720do |
| 0300 0400         | Peru, R Vision                        | 4790do  |        |
| 0300 0400         | Spain, R Exterior de Espana           | 3350ca  | 5995sa |
|                   |                                       | 6055na  | 6125ca |
|                   |                                       | 9630na  | 9535ca |
| 0300 0400 mtwhfas | USA, BBG/R Marti                      | 6030ca  | 7405ca |
| 0300 0400         | USA, WEWN/EWTN Irondale AL            | 5810ca  |        |
|                   |                                       | 11870sa |        |
| 0300 0400         | USA, WYFR/Family R Worldwide          | 6875sa  |        |
|                   |                                       | 9385sa  |        |
| 0320 0400         | Vatican City State, Vatican R         | 7305na  |        |

**MT SHORTWAVE STATION RESOURCE GUIDE**

|  |  |
|--|--|
| Afghanistan, RTV Afghanistan.....            | <a href="http://www.rta.org.af">www.rta.org.af</a>   |
| Albania, R Tirana.....                       | <a href="http://rtsh.sil.at/">http://rtsh.sil.at/</a>  |
| Angola, Angolan National R.....              | <a href="http://www.rna.ao/">www.rna.ao/</a>   |
| Anguilla, University Network.....            | <a href="http://www.worldwideuniversitynetwork.com/">www.worldwideuniversitynetwork.com/</a> |
| Argentina, RAE.....                          | <a href="http://www.radionacional.gov.ar">www.radionacional.gov.ar</a>                       |
| Australia, ABC NT Alice Springs.....         | <a href="http://www.abc.net.au/radio/">www.abc.net.au/radio/</a>                             |
| Australia, ABC NT Katherine.....             | <a href="http://www.abc.net.au/radio/">www.abc.net.au/radio/</a>                             |
| Australia, ABC NT Tennant Creek.....         | <a href="http://www.abc.net.au/radio/">www.abc.net.au/radio/</a>                             |
| Australia, ABC/R Australia.....              | <a href="http://www.radioaustralia.net.au">www.radioaustralia.net.au</a>                     |
| Australia, HCJB Global Australia.....        | <a href="http://www.hcjb.org.au">www.hcjb.org.au</a>   |
| Austria, AWR Europe.....                     | <a href="http://www.awr2.org">www.awr2.org</a>   |
| Austria, TWR Europe.....                     | <a href="http://www.twr.org">www.twr.org</a>   |
| Bahrain, R Bahrain.....                      | <a href="http://www.radiobahrain.com">www.radiobahrain.com</a>                               |
| Belgium, TDP Radio.....                      | <a href="http://www.airtime.be/schedule.html">www.airtime.be/schedule.html</a>               |
| Canada, Bible Voice Broadcasting.....        | <a href="http://www.biblevoice.org/">www.biblevoice.org/</a>                                 |
| Canada, CFRX Toronto ON.....                 | <a href="http://www.cfrb.com">www.cfrb.com</a>   |
| Canada, CFVP Calgary AB.....                 | <a href="http://www.classiccountryam1060.com">www.classiccountryam1060.com</a>               |
| Canada, CKZN St Johns NF.....                | <a href="http://www.cbc.ca/listen/index.html">www.cbc.ca/listen/index.html</a>               |
| Canada, CKZU Vancouver BC.....               | <a href="http://www.cbc.ca/bc">www.cbc.ca/bc</a>   |
| China, China R International.....            | <a href="http://www.cri.cn">www.cri.cn</a>   |
| China, Haixa zhi Sheng/VO Strait.....        | <a href="http://www.vos.com.cn">www.vos.com.cn</a>   |
| Clandestine, JSR/Shiokaze/Sea Breeze.....    | <a href="http://www.chosa-kai.jp">www.chosa-kai.jp</a>                                       |
| Clandestine, Sudan R Service.....            | <a href="http://www.sudanradio.org">www.sudanradio.org</a>                                   |
| Cuba, R Havana Cuba.....                     | <a href="http://www.radiohc.cu/">www.radiohc.cu/</a>   |
| Ecuador, HCJB/LV de los Andes.....           | <a href="http://www.radiohcjb.org">www.radiohcjb.org</a>                                     |
| Egypt, R Cairo.....                          | <a href="http://www.ertu.org">www.ertu.org</a>   |
| Eq Guinea, Pan Am BC/R Africa.....           | <a href="http://www.radiopanam.com/">www.radiopanam.com/</a>                                 |
| Ethiopia, R Ethiopia.....                    | <a href="http://www.erta.gov.com">www.erta.gov.com</a>                                       |
| Ethiopia, R Ethiopia/Natl Pgm.....           | <a href="http://www.erta.gov.com">www.erta.gov.com</a>                                       |
| France, R France International.....          | <a href="http://www.rfi.fr/">www.rfi.fr/</a>   |
| Germany, AWR Europe.....                     | <a href="http://www.awr2.org/">www.awr2.org/</a>   |
| Germany, Deutsche Welle.....                 | <a href="http://www.dw.de">www.dw.de</a>   |
| Germany, Mighty KBC Radio.....               | <a href="http://www.kbcradio.eu/">www.kbcradio.eu/</a>                                       |
| Germany, TWR Europe.....                     | <a href="http://www.twr.org">www.twr.org</a>   |
| Guam, KTWR/TWR Asia.....                     | <a href="http://nea.ktwr.net/">http://nea.ktwr.net/</a>                                      |
| India, AIR/Aizawl.....                       | <a href="http://www.allindiaradio.org/">www.allindiaradio.org/</a>                           |
| India, AIR/Bhopal.....                       | <a href="http://www.allindiaradio.org/">www.allindiaradio.org/</a>                           |
| India, AIR/Chennai.....                      | <a href="http://www.allindiaradio.org/">www.allindiaradio.org/</a>                           |
| India, AIR/Gangkok.....                      | <a href="http://www.allindiaradio.org/">www.allindiaradio.org/</a>                           |
| India, AIR/Guwahati.....                     | <a href="http://www.allindiaradio.org/">www.allindiaradio.org/</a>                           |
| India, AIR/Hyderabad.....                    | <a href="http://www.allindiaradio.org/">www.allindiaradio.org/</a>                           |
| India, AIR/Imphal.....                       | <a href="http://www.allindiaradio.org/">www.allindiaradio.org/</a>                           |
| India, AIR/Itanagar.....                     | <a href="http://www.allindiaradio.org/">www.allindiaradio.org/</a>                           |
| India, AIR/Jaipur.....                       | <a href="http://www.allindiaradio.org/">www.allindiaradio.org/</a>                           |
| India, AIR/Jeyppore.....                     | <a href="http://www.allindiaradio.org/">www.allindiaradio.org/</a>                           |
| India, AIR/Kolkata.....                      | <a href="http://www.allindiaradio.org/">www.allindiaradio.org/</a>                           |
| India, AIR/Kuresong.....                     | <a href="http://www.allindiaradio.org/">www.allindiaradio.org/</a>                           |
| India, AIR/Lucknow.....                      | <a href="http://www.allindiaradio.org/">www.allindiaradio.org/</a>                           |
| India, AIR/Mumbai.....                       | <a href="http://www.allindiaradio.org/">www.allindiaradio.org/</a>                           |
| India, AIR/Port Blair/Andaman & Nicobar..... | <a href="http://www.allindiaradio.org/">www.allindiaradio.org/</a>                           |
| India, AIR/Shillong.....                     | <a href="http://www.allindiaradio.org/">www.allindiaradio.org/</a>                           |
| India, AIR/Shimla.....                       | <a href="http://www.allindiaradio.org/">www.allindiaradio.org/</a>                           |
| India, AIR/Thiruvananthapuram.....           | <a href="http://www.allindiaradio.org/">www.allindiaradio.org/</a>                           |
| India, AIR/External Service.....             | <a href="http://www.allindiaradio.org/">www.allindiaradio.org/</a>                           |
| India, AIR/R Kashmir.....                    | <a href="http://www.allindiaradio.org/">www.allindiaradio.org/</a>                           |
| Indonesia, AWR Asia/Pacific.....             | <a href="http://www.awr2.org/">www.awr2.org/</a>   |

|   |  |
|---|--|
| Indonesia, VO Indonesia.....            | <a href="http://www.voi.co.id">www.voi.co.id</a>   |
| Iran, VO Islamic Rep of Iran.....       | <a href="http://www.irib.ir/English/">www.irib.ir/English/</a>                                       |
| Israel, Kol Israel.....                 | <a href="http://www.intkolisrael.com">www.intkolisrael.com</a>                                       |
| Italy, IRRS SW.....                     | <a href="http://www.nexus.org">www.nexus.org</a>   |
| Japan, R Japan NHK World.....           | <a href="http://www.nhk.or.jp/english/">www.nhk.or.jp/english/</a>                                   |
| Kuwait, R Kuwait.....                   | <a href="http://www.media.gov.kw/">www.media.gov.kw/</a>   |
| Mali, ORTM/R Mali.....                  | <a href="http://www.ortm.ml">www.ortm.ml</a>   |
| Micronesia, V6MP/Cross R/Pohnpei.....   | <a href="http://www.pmapacific.org/">www.pmapacific.org/</a>   |
| Moldova, R PMR/Pridnestrovye.....       | <a href="http://www.radiopmr.org">www.radiopmr.org</a>   |
| Nepal, R Nepal.....                     | <a href="http://www.radionepal.org/">www.radionepal.org/</a>   |
| Netherlands, XVRB Radio.....            | <a href="http://www.twr.org">www.twr.org</a>   |
| New Zealand, R New Zealand Intl.....    | <a href="http://www.rnzi.com">www.rnzi.com</a>   |
| Nigeria, Voice of Nigeria.....          | <a href="http://www.voiceofnigeria.org">www.voiceofnigeria.org</a>                                   |
| North Korea, Voice of Korea.....        | <a href="http://www.vok.rep.kp">www.vok.rep.kp</a>   |
| Oman, R Sultanate of Oman.....          | <a href="http://www.oman-tv.gov.om">www.oman-tv.gov.om</a>   |
| Pakistan, PBC/R Pakistan.....           | <a href="http://www.radio.gov.pk">www.radio.gov.pk</a>   |
| Palau, T8WH/World Harvest R.....        | <a href="http://www.whr.org/">www.whr.org/</a>   |
| Philippines, R Pilipinas Overseas.....  | <a href="http://www.pbs.gov.ph/">www.pbs.gov.ph/</a>   |
| Poland, Polish Radio/External Svc.....  | <a href="http://www.polskieradio.pl">www.polskieradio.pl</a>   |
| Romania, R Romania Intl.....            | <a href="http://www.rri.ro/">www.rri.ro/</a>   |
| Russia, Voice of Russia.....            | <a href="http://english.ruvr.ru/">http://english.ruvr.ru/</a>  |
| Saudi Arabia, BSKSA/External Svc.....   | <a href="http://www.saudiradio.net/">www.saudiradio.net/</a>   |
| Serbia, International R Serbia.....     | <a href="http://voiceofserbia.org">http://voiceofserbia.org</a>                                      |
| South Africa, AWR Africa.....           | <a href="http://www.awr2.org/">www.awr2.org/</a>   |
| South Africa, Channel Africa.....       | <a href="http://www.channelafrica.org">www.channelafrica.org</a>                                     |
| South Africa, CVC 1 Africa R.....       | <a href="http://www.1africa.tv">www.1africa.tv</a>   |
| South Korea, KBS World R.....           | <a href="http://www.worldkbs.co.kr">www.worldkbs.co.kr</a>   |
| Spain, R Exterior de Espana.....        | <a href="http://www.ree.rne.es/">www.ree.rne.es/</a>   |
| Sri Lanka, SLBC.....                    | <a href="http://www.slbc.lk">www.slbc.lk</a>   |
| Swaziland, TWR Africa.....              | <a href="http://www.twrafrica.org/">www.twrafrica.org/</a>   |
| Syria, R Damascus.....                  | <a href="http://www.rtv.gov.sy/">www.rtv.gov.sy/</a>   |
| Taiwan, R Taiwan Intl.....              | <a href="http://english.rti.org.tw/">http://english.rti.org.tw/</a>                                  |
| Thailand, R Thailand World Svc.....     | <a href="http://www.hsk9.org/">www.hsk9.org/</a>   |
| Turkey, Voice of Turkey.....            | <a href="http://www.voturkey.com">www.voturkey.com</a>   |
| Uganda, Dunamis Shortwave.....          | <a href="http://www.biblevoice.org/stations/east-africa">www.biblevoice.org/stations/east-africa</a> |
| UK, BBC World Service.....              | <a href="http://www.bbc.co.uk/worldservice/">www.bbc.co.uk/worldservice/</a>                         |
| USA, Amer Forces Network/AFRTS.....     | <a href="http://myafn.dodmedia.osd.mil/">http://myafn.dodmedia.osd.mil/</a>                          |
| USA, BBG/Voice of America.....          | <a href="http://www.voanews.com">www.voanews.com</a>   |
| USA, BBG/Voice of America/Studio 7..... | <a href="http://www.voanews.com">www.voanews.com</a>   |
| USA, FBN/WTJC Newport NC.....           | <a href="http://www.fbnradio.com/">www.fbnradio.com/</a>   |
| USA, KNLS Anchor Point AK.....          | <a href="http://www.knls.org/">www.knls.org/</a>   |
| USA, Overcomer Ministry.....            | <a href="http://www.overcomerministry.org">www.overcomerministry.org</a>                             |
| USA, Pan Amer Broadcasting.....         | <a href="http://www.radiopanam.com/">www.radiopanam.com/</a>   |
| USA, WBCQ Monticello ME.....            | <a href="http://www.wbcq.com/">www.wbcq.com/</a>   |
| USA, WEWN/EWTN Irondale AL.....         | <a href="http://www.ewtn.com/">www.ewtn.com/</a>   |
| USA, WHRI Cypress Creek SC.....         | <a href="http://www.whr.org/">www.whr.org/</a>   |
| USA, WINB Red Lion PA.....              | <a href="http://www.winb.com">www.winb.com</a>   |
| USA, WRMI/R Prague relay.....           | <a href="http://www.wrmi.net/">www.wrmi.net/</a>   |
| USA, WRMI/R Slovakia Intl relay.....    | <a href="http://www.wrmi.net/">www.wrmi.net/</a>   |
| USA, WTWW Lebanon TN.....               | <a href="http://www.wtww.us/">www.wtww.us/</a>   |
| USA, WWCN Nashville TN.....             | <a href="http://www.wwcn.com">www.wwcn.com</a>   |
| USA, WWRB Manchester TN.....            | <a href="http://www.wwrb.org/">www.wwrb.org/</a>   |
| USA, WYFR/Family R Worldwide.....       | <a href="http://www.familyradio.com/">www.familyradio.com/</a>                                       |
| Vatican City State, Vatican R.....      | <a href="http://www.vaticanradio.org/">www.vaticanradio.org/</a>                                     |
| Vietnam, VO Vietnam/Overseas Svc.....   | <a href="http://www.vov.org.vn">www.vov.org.vn</a>   |
| Zambia, Christian Voice.....            | <a href="http://www.voiceafrica.net">www.voiceafrica.net</a>   |
| Zambia, CVC Intl/1 Africa.....          | <a href="http://www.1africa.tv">www.1africa.tv</a>   |



# Is the Cold War Really Over?

**D**uring the middle part of this last summer, Bill Gertz on the *Washington Free Beacon* website, published an interesting article regarding Russian military aircraft operating near the West Coast of the United States.

According to Gertz, "Two Russian strategic nuclear bombers entered the U.S. air defense zone near the Pacific coast and were met by U.S. interceptor jets.

"It was the second time Moscow dispatched nuclear-capable bombers into the 200-mile zone surrounding U.S. territory in a two week period.

"An earlier intrusion by two Tu-95 Bear H bombers took place near Alaska as part of arctic war games that a Russian military spokesman said included simulated attacks on 'enemy' air defenses and strategic facilities.

"A defense official said the Pacific coast intrusion came close to the U.S. coast but did not enter the 12-mile area that the U.S. military considers sovereign airspace.

"The bomber flights near the Pacific and earlier flights near Alaska appear to be signs Moscow is practicing the targeting of its long-range air-launched cruise missiles on two strategic missile defense sites, one at Fort Greely, Alaska, and a second site at Vandenberg Air Force Base, California."

If you are new to Milcom monitoring and want to monitor DoD Air Defense action, program the following nationwide frequencies in your scanner:

|                       |                  |         |
|-----------------------|------------------|---------|
| 228.900               | 232.500 (Canada) | 234.600 |
| 234.700 (Canada)      | 235.900          | 238.400 |
| 241.200               | 252.000          | 254.200 |
| 254.475               | 260.900          | 265.400 |
| 270.200               | 274.400          | 277.600 |
| 278.000               | 281.600          | 282.600 |
| 288.400               | 293.600          | 316.300 |
| 320.600               | 324.000          | 327.900 |
| 328.000               | 349.550          | 355.200 |
| 360.150               | 364.200          | 369.000 |
| 386.000 MHz (AM mode) |                  |         |

HF monitors should keep an eye on: 4727.0 5705.0 6736.0 9022.0 13206.0 15046.0 18027.0 kHz USB. These HF frequencies are all tertiary backup frequencies at best between the AWACS and NORAD air defense sectors. They are also shared with other DoD users and are *NOT* dedicated NORTHCOM/USAF/NORAD frequencies.

Don't expect to hear a lot of air defense communications on these HF frequencies compared to years past. Most of the old HF stuff we use to hear has now moved onto a secure UHF miltatcom channel, referred to many times by aircrews on their UHF milair frequencies listed above.

## ❖ UHF Miltatcom Pirates Still Active

In the June 2009 *MT Milcom* column, I documented that some Brazilian pirates had been chased off of several DoD UHF miltatcom frequencies. Well, the quiet observed shortly after the bust did not last for long, and those miltatcom pirates and many others are just as active as ever on DoD's miltat downlink frequencies. If you are interested in hearing some of their activity, the frequency list that follows is a list of recent activity observed from here on the East Coast of the United States. Mode is NFM and frequencies are in MHz.

|         |         |         |         |
|---------|---------|---------|---------|
| 252.050 | 255.450 | 255.550 | 256.850 |
| 256.950 | 257.425 | 258.550 | 260.525 |
| 261.600 | 262.200 | 263.875 | 263.925 |
| 265.550 | 268.250 |         |         |

Also if you are interested in hearing some clear military voice activity on UHF military satellites, keep an eye on the frequencies listed below for occasional activity in the clear (again this is a US East Coast centric list).

|         |         |         |         |
|---------|---------|---------|---------|
| 251.850 | 252.150 | 253.650 | 253.650 |
| 253.850 | 255.350 | 258.650 | 260.475 |
| 260.625 | 260.725 | 261.450 | 261.575 |
| 261.675 | 261.800 | 261.850 | 261.875 |
| 262.125 | 263.575 | 263.875 | 263.925 |
| 263.950 | 265.250 | 266.050 | 267.050 |
| 268.150 | 268.450 | 269.650 | 269.950 |

## ❖ UHF Milcom Spectrum Holes

I have written a lot over the years in this column and in other media about what I call "spectrum holes" in the 225-400 MHz range.

In brief, a spectrum hole is a legitimate frequency for assignment based on current channel spacing and the DoD bandplan, but it's one on which no activity or current assignment has ever been heard or found. That is a spectrum hole.

If you are interested in exploring the world of 225-400 MHz spectrum holes, here is the latest list for those who want a monitoring challenge. And if you hear something or know something about any of these frequencies, I would appreciate an email at the address in the masthead or via our new email address – [milcommp@gmail.com](mailto:milcommp@gmail.com).

|         |         |         |         |
|---------|---------|---------|---------|
| 226.250 | 234.175 | 236.925 | 239.075 |
| 244.675 | 244.925 | 245.075 | 248.525 |
| 248.775 | 249.675 | 249.725 | 250.375 |
| 250.475 | 250.575 | 250.875 | 251.625 |
| 251.675 | 252.375 | 252.450 | 252.875 |
| 253.175 | 253.425 | 254.625 | 254.875 |

|         |         |         |         |
|---------|---------|---------|---------|
| 255.025 | 255.325 | 255.475 | 255.525 |
| 255.675 | 256.425 | 256.975 | 258.025 |
| 258.475 | 258.525 | 259.075 | 259.625 |
| 259.775 | 264.475 | 265.375 | 265.475 |
| 265.625 | 265.875 | 266.825 | 266.925 |
| 267.025 | 267.125 | 267.225 | 267.325 |
| 267.950 | 267.975 | 268.325 | 269.875 |
| 269.925 | 270.075 | 270.425 | 270.475 |
| 270.925 | 271.050 | 271.775 | 271.925 |
| 274.225 | 274.275 | 274.925 | 275.075 |
| 275.625 | 275.725 | 276.175 | 276.725 |
| 276.775 | 276.875 | 277.475 | 277.575 |
| 277.675 | 277.775 | 277.875 | 277.975 |
| 278.525 | 279.325 | 293.075 | 293.575 |
| 297.925 | 305.975 | 306.275 | 306.475 |
| 306.525 | 306.675 | 307.825 | 307.925 |
| 308.375 | 308.675 | 310.025 | 310.175 |
| 310.275 | 310.775 | 310.875 | 311.075 |
| 311.875 | 316.475 | 318.425 | 318.625 |
| 318.775 | 319.075 | 324.225 | 326.375 |
| 326.425 | 342.625 | 346.475 | 346.575 |
| 348.075 | 349.875 | 350.175 | 358.775 |
| 360.175 | 361.525 | 365.675 | 365.975 |
| 367.575 | 368.925 | 369.375 | 375.975 |
| 377.475 | 377.750 | 378.075 |         |

## ❖ 380-400 MHz Aero Frequencies?

As most longtime readers of this column are aware (see our *MT Milcom* Jun/Sep/Dec 2004 and Feb/May 2005 columns to name a few with our exclusive coverage), the Department of Defense has carved out of the 225-400 MHz milair band some select frequencies for use by land/shipboard trunk radio systems as well as simplex (Land Mobile Radio) LMR activity. This new subband lies in the 380-400 MHz range and the spacing is 12.5 kHz.

But not all the frequencies in this new subband are being used for LMR activity. There are still some aeronautical frequency assignments in this range. The following frequencies are still being used for aeronautical use (AM mode).

|         |         |         |         |
|---------|---------|---------|---------|
| 380.000 | 380.025 | 380.050 | 380.100 |
| 380.150 | 380.200 | 380.225 | 380.250 |
| 380.300 | 380.350 | 380.500 | 380.600 |
| 380.700 | 380.850 | 380.925 | 381.000 |
| 381.025 | 381.050 | 381.100 | 381.125 |
| 381.150 | 381.225 | 381.250 | 381.300 |
| 381.350 | 381.375 | 381.400 | 381.450 |
| 381.475 | 381.500 | 381.525 | 381.550 |
| 381.575 | 381.600 | 381.650 | 382.000 |
| 384.400 | 384.500 | 385.000 | 385.050 |
| 385.200 | 385.400 | 385.425 | 385.450 |
| 385.475 | 385.500 | 385.525 | 385.550 |
| 385.575 | 385.600 | 385.650 | 386.000 |
| 386.875 | 387.000 | 387.025 | 387.050 |
| 387.075 | 387.100 | 387.125 | 388.950 |
| 389.000 | 392.200 | 395.050 | 395.150 |
| 395.225 | 395.250 | 395.375 | 395.825 |
| 396.900 | 398.100 |         |         |



So give these aero frequencies a listen in your area and let us know what you are hearing.

## ❖ CAP Aircraft Radios to Encrypt

We have received word that the Civil Air Patrol headquarters at Maxwell AFB, Alabama, recently received the first of four TDFM-136A VHF/FM aircraft radios. This is the new model FM radios that are being considered for use by the CAP and may be phased-in over the next few years if testing proves successful. This new model has several key features, but the most important upgrade with these radios is the ability to support encryption via the P25 digital mode.

Most of the CAP ground LMR equipment nationwide is already encryption-capable, but the aviation radio assets are not. With the introduction of this new Technisonic "A" model, encryption could then be incorporated into their aircraft fleet, thereby enabling the entire CAP LMR radio system to support missions requiring secure communications.

According to information that we received, the first four TDFM-136A model radios were sent to Texas for formal testing at the Lone Star Emergency Services Academy (LESA). The first test radio was installed in a Texas Wing aircraft and the results indicated that the new radios worked exceptionally well. The Texas testers were able to achieve seamless encrypted communications between CAP ground-based LMR radios and the TDFM-136A in the aircraft.

According to another source this is a multi-year plan to upgrade the CAP aircraft fleet. Civil Air Patrol is now flying an increasing number of homeland security related missions requiring secure communications, and up until this point those have been difficult to support due to lack of P25 encryption capability. Once encryption is in wide spread use across all the CAP platforms, CAP will then be able to start accepting some missions that they previously could not, as well as develop new missions that were formerly impossible for them to support.

## ❖ Milair Nationwide Frequency Updates

Here are the latest milair frequency changes from the Federal Aviation Administration (FAA) and the Department of Defense (DoD). All frequencies are in MHz and mode is AM unless otherwise noted.

- 32.700 Fort Drum/Wheeler-Sack AAF, NY (KGTB) R-5201 Air-to-Air (ex-71.300)
- 41.500 Fort Rucker/Hanchey AHP, AL (KHEY) Flight Following for all Fort Rucker AOs.
- 119.675 Alexandria International, LA (KAEX) Ground Controlled Approach paired with 239.000 (ex-125.400).
- 119.825 Camp Guernsey, WV (KV76) AWOS (ex-118.925)
- 124.550 Beale AFB, CA (KBAB) VHF ATIS (operational during wing operations)
- 124.875 Fort Drum/Wheeler-Sack AAF, NY (KGTB) Sack Approach Control (ex-128.250)

- 126.200 Fort Benning/Lawson AAF, GA (KLSE) Base Operations/Pilot-to-Dispatcher Doughboy Advisory (PTD) (ex-138.525)
- 128.200 John Murtha Johnstown-Cambria County, PA (KJST) RAPCON West Sector paired with 288.325
- 135.525 Fort Rucker/Hanchey AHP, AL (KHEY) Flight Following 2 (HUB North) paired with 324.550 for AO Vanguard North.
- 135.975 John Murtha Johnstown-Cambria County, PA (KJST) RAPCON East Sector paired with 244.875
- 139.250 Fort Rucker/Hanchey AHP, AL (KHEY) Flight Following 1 (HUB Central) paired with 323.750 for AO Bearcat and Vanguard Central.
- 140.250 Fort Rucker/Hanchey AHP, AL (KHEY) Flight Following 2 (HUB North) paired with 367.350 for AO Hawk.
- 141.100 Fort Rucker/Hanchey AHP, AL (KHEY) Flight Following 3 (HUB South) paired with 310.450/350.075 for AO Vanguard South.
- 233.700 Fort Drum/Wheeler-Sack AAF, NY (KGTB) SE Operations (ex-280.800)
- 237.200 Fort Bliss/Biggs AAF, TX (KBIF) Bliss Radio (ex-397.700)
- 239.000 Alexandria International, LA (KAEX) Ground Controlled Approach paired with 119.675.
- 244.875 John Murtha Johnstown-Cambria County, PA (KJST) RAPCON East Sector paired with 135.975
- 254.425 Martin State Airport, MD (KMTN) Tower (ex-297.200)
- 256.350 MCAGCC Twentynine Palms SELF, CA (KNXP) EAF ATIS (ex-386.350)
- 269.025 NAS Lemoore (Reeves Field), CA (KNLC) Approach Control Primary
- 273.500 MCAS Yuma/Yuma International, AZ (KNYL ex-KYUM) ATIS
- 275.700 Martin State Airport, MD (KMTN) ACC A-10 Operations (Raven Ops)
- 276.000 MCAS Yuma/Yuma International, AZ (KNYL ex-KYUM) Approach Control West (Yuma Range)
- 281.400 MCAS Yuma/Yuma International, AZ (KNYL ex-KYUM) Approach Control Low
- 288.325 John Murtha Johnstown-Cambria County, PA (KJST) RAPCON West Sector paired with 128.200
- 293.300 Martin State Airport, MD (KMTN) AMC C-27 Operations Crab Ops
- 297.900 Eastern WV Regional (Shepherd Field), WV (KMRB) A/G Facility Galaxy
- 308.000 Fort Rucker/Cairns AAF, AL (KOZR) Tower East UHF Primary (Louisville Stagefield)
- 308.400 NAS/JRB New Orleans (Alvin Callender Field), LA (KNBG) Ground Control (ex-382.800)
- 310.450 Fort Rucker/Hanchey AHP, AL (KHEY) Flight Following 3 (HUB South) paired with 141.100/350.075 for AO Vanguard South.
- 314.000 MCAS Yuma/Yuma International, AZ (KNYL ex-KYUM) Ground Control
- 316.000 Fort Rucker/Goldberg Stagefield, AL (12AL) Pilot-to-Dispatcher (PTD)
- 317.500 Fort Drum/Wheeler-Sack AAF, NY (KGTB) Metro (ex-304.800)
- 319.250 Fort Drum/Wheeler-Sack AAF, NY (KGTB) R-5201 Flight Following Advisories Drum Radio (ex-397.750)
- 323.750 Fort Rucker/Hanchey AHP, AL (KHEY) Flight Following 1 (HUB Central) paired with 139.250 for AO Bearcat and Vanguard Central.
- 324.100 Minneapolis-St. Paul International (Wold Chamberlain), MN (KMSP) Minneapote Air National Guard Base Operations (ex-252.1000)
- 324.550 Fort Rucker/Hanchey AHP, AL (KHEY) Flight Following 2 (HUB North) paired with 135.525 for AO Vanguard North.
- 327.150 NAS Lemoore (Reeves Field), CA (KNLC) ATIS

- 349.400 Scott AFB (MidAmerica), IL (KBLV) Command Post
- 350.075 Fort Rucker/Hanchey AHP, AL (KHEY) Flight Following 3 (HUB South) paired with 141.100/310.450 for AO Vanguard South.
- 351.675 NAS/JRB Forth Worth (Carswell Field), TX (KNFW) ATIS (ex-273.575) (Note: This should be a temporary assignment)
- 360.850 MCAS Yuma/Yuma International, AZ (KNYL ex-KYUM) Secondary Tower
- 362.950 Hanscom AFB (Laurence G. Hanscom Field), MA (KBED) Hanscom ESD Command Post (ex-397.100)
- 363.200 Fort Drum/Wheeler-Sack AAF, NY (KGTB) ATIS paired with 119.525 (ex-367.700)
- 367.350 Fort Rucker/Hanchey AHP, AL (KHEY) Flight Following 2 (HUB North) paired with 140.250 for AO Hawk.
- 371.900 NAS Lemoore (Reeves Field), CA (KNLC) Clearance Delivery
- 372.000 MCAS Yuma/Yuma International, AZ (KNYL ex-KYUM) Approach Control High
- 382.000 MCAS Yuma/Yuma International, AZ (KNYL ex-KYUM) Primary Tower

## ❖ A Good Friend Has Left Us

I close this month's column with some sad news. Long time milcom monitor Don G. Edwards, N2NUM, has passed away after a brief battle with cancer.

Don was born on April 6, 1954. He was an avid musician playing in many local bands in the Northville, New York area – BlackRiver for 20 plus years and more recently Steel Heart. He was also an accomplished photographer with many military aviation pictures published in this magazine. He enjoyed listening to and taking photos of military aircraft.

Don worked at Coleco industries for many years and at Universal Custom Mill Work. Don was especially active on the Northeast milair list and many of his friends paid tribute to him in the days after his death was announced.

On behalf of the entire MT staff I want to pass along my deepest sympathies to Nancy and the family. Don was a great friend and milcom monitor. He will be missed by all of us who knew him. Smoke off, my friend.

Until next month, 73 and good hunting all.



Don G. Edwards Jr. at an air show. (Photo by Kevin Burke)



# A Fed Files Radio Safari – Southern Nevada

**A**s I have mentioned in some of my previous columns, I am lucky to have a job that calls for a lot of travel all over the country. Most of the time I have some limited time in the hotel room for setting up a scanner or two and monitoring the local radio spectrum, and other times I'm just too busy for any serious monitoring. But occasionally I get really lucky and have some days off work in a really interesting location for radio monitoring. I recently had that luck in Las Vegas, Nevada.

In addition to the tremendous amount of local radio traffic from the many hotels, casinos and entertainment establishments in Las Vegas, there are quite a few interesting federal and military monitoring targets in and around the Las Vegas area. I decided to take advantage of the free time in the area and planned a short road trip around the area, a "radio safari" if you will.



With all the extra potential for monitoring, I decided to bring a few extra radios along with the three hand-held scanners I normally carry along with me on my travels. I normally carry a GRE PSR-500, a Uniden 396T and 396XT, and lots of batteries. In addition, I brought the Radio Shack PRO-197 digital scanner (the same as the GRE PSR-600) and my trusty Uniden BCT-780 XLT. The 780XLT was programmed with many of the VHF & UHF military aircraft channels that have been posted by local listeners.

In addition to the federal land-mobile radio traffic, there is an awful lot of UHF and VHF aircraft traffic to be heard. The Nellis Air Force Base training ranges can be really busy at times and can provide some fascinating radio traffic from the various fighter aircraft and range controllers. I have not yet made the trek to the area during the famous RED FLAG air exercises, but hope to some day.

The 406 - 420 MHz federal band is saturated with radio traffic in southern Nevada, mainly due to several wide-area, federal UHF trunked radio systems in the area. One system, a multi-site Motorola UHF trunked system,

belongs to the National Nuclear Security Administration (NNSA) and covers Las Vegas and the 1400 square mile Nevada Nuclear Security Site (formerly known as the Nevada Test Site), the Department of Energy operated testing site for all things nuclear.

Here is the NNSA trunked system information:

- Motorola Type II, System ID: 7526 NAC: N264
- Site 01 - Mercury  
406.5000, 406.7875, 407.1875,  
407.3000, 407.5000, 407.8625,  
408.1500, 409.1125, 409.5625
  - Site 02 - Red Mountain, Checkpoint Pass  
406.9875, 407.3500, 408.3625, 409.3125,  
409.5250, 409.9125, 410.1625
  - Site 03 - Yucca Pass  
406.1375, 407.3625, 408.1875, 409.1250,  
409.3500, 409.5500, 409.7875
  - Site 04 - Las Vegas DOE Facility  
406.4000, 406.9875, 407.3625, 408.3625,  
409.5250, 409.9250, 410.1625
  - Site 05 - Skull Mountain  
406.1500, 406.9750, 407.5500, 408.1000
  - Site 06 - Angel Peak  
406.1125, 406.5500, 407.4250
  - Site 07 - Rainier Mesa  
407.1625, 407.4000, 407.7875, 408.3875
  - Site 08 - Shoshone Mountain  
407.3875, 407.8125, 408.4250,  
409.3750, 410.1750, 410.6500

Next, there is a three-site P-25 UHF system being used by Nellis Air Force Base and its associated base, Creech AFB in Indian Springs, NV. Nellis moved to their own trunked system after being a subscriber to the NSSA trunked system for years. Here is their new trunked system information:

- System ID: 00F WACN: 58544 NAC: N00F
- Site 01 - Nellis AFB  
406.5000, 406.7875, 407.1875,  
407.3000, 407.5000, 407.8625,  
408.1500, 408.9625, 409.1125,  
409.5625, 409.7125, 410.6500
  - Site 02 - Creech AFB  
406.3625, 407.0750, 407.5875,  
408.1750, 408.7000
  - Site 10 - Angel Peak  
409.3000, 409.6000, 410.5500

There is also a multi-site EDACS trunked radio system being utilized by the military on what is referred to as the Nevada Test and Training Range (NTTR). This system is using either ProVoice or AEGIS digital mode (depending on who you ask) and cannot be monitored due to encryption. However you can monitor the system activity with EDACS control channel analysis software, such as E TRUNKER. Here are the

NTTR sites, with the Logical Channel Numbers (LCN) listed by each frequency:

- Site 01 – Tonopah  
[1] 406.5625 [2] 409.5625 [3] 410.7000
- Site 02 – Antelope Peak  
[1] 406.1500 [2] 407.2500 [3] 407.9500  
[4] 408.5875 [5] 410.1500
- Site 03 – Cedar Peak  
[1] 406.9625 [2] 407.5625 [3] 407.7625  
[4] 408.1250 [5] 409.1625 [6] 409.8875
- Site 04 – Halligan Mesa  
[1] 406.7625 [2] 409.3625 [3] 409.7625
- Site 05 – Bald Mountain  
[1] 406.7750 [2] 407.8875 [3] 408.9625  
[4] 410.3500 [5] 410.7625
- Site 06 – Papoose Mountain  
[1] 406.1875 [2] 408.1625 [3] 408.5625  
[4] 409.5875 [5] 410.7000
- Site 07 – Angel Peak  
[1] 406.5625 [2] 408.0500 [3] 409.0250  
[4] 409.9625 [5] 410.9000
- Site 08 – Black Mountain  
[1] 406.3625 [2] 407.0750 [3] 407.5875  
[4] 408.1750 [5] 409.6375
- Site 09 – Creech AFB  
[1] 406.1500 [2] 407.2500 [3] 407.9500  
[4] 408.5875 [5] 410.1500

Some information is floating out on the Internet that the NTTR EDACS trunked system is being supplemented by a new DoD 380 MHz P-25 digital radio system. I did not pick up any of these sites during my expedition, but reportedly there are several sites on the air over on the eastern side of the NTTR (Area 51 territory), though not much traffic has been heard using them. For additional information on this and other southern Nevada military radio subjects, be sure and check out [www.dreamlandresort.com](http://www.dreamlandresort.com).

On this trip I also discovered a new UHF P-25 trunked radio system that I had not heard on the air before. It turned out to belong to the Las Vegas VA Medical Center police. It appears to be located at the new VA Medical Center on the north side of town, near Nellis AFB. Some traffic monitored at the time seemed to show that they were still working on getting the new facility built and finished.

- System ID: 49D WACN: BEE00 NAC: N490  
407.83750 408.23750 409.51250

Once I got the mobile unit set up with radios and antennas, along with cold drinks and snacks, I headed out and found a few places to sit and monitor for a while. I parked at Creech AFB, in Indian Springs, Nevada. There I was able to watch and monitor flight training activity of the MQ-1 and MQ-9 Unmanned Aerial Vehicles





(UAV). Several UAVs were in the pattern at Crech simultaneously and some of the radio traffic indicated that the control tower was keeping very busy coordinating everything.

Later, I moved up to Mercury, Nevada, the headquarters for the Department of Energy operations. Although there is some encryption on the NNSA trunked system, a majority of routine communications can be found in the clear. Some activity seems to be normal day-to-day maintenance and operational traffic, but I did happen to hear the preparations for the operation to take down the BREN tower on May 23<sup>rd</sup>, [http://en.wikipedia.org/wiki/BREN\\_Tower](http://en.wikipedia.org/wiki/BREN_Tower).

I also parked up near Angel Peak at about 6500 feet and was able to hear traffic from quite distance. One interesting intercept was traffic from Zion National Park in Utah. At the time, I wasn't sure who I was listening to, but there was a tremendous amount of radio traffic regarding a car burning in a tunnel. Oddly, some of the traffic was analog, and some was P-25 digital, so the system is multi-mode. I couldn't figure out where this was at the time I was listening, and couldn't find any information on the local news.

But a week later, I caught an item on an automotive web site that I frequent and found the story behind the fire. It turned out to be an \$800,000 1964 Shelby Cobra sports car that had caught fire while in the Zion-Mount Carmel tunnel! More information on the fire can be found here: <http://home.nps.gov/applications/digest/headline.cfm?type=Incidents&id=6168>

Another interesting intercept was 446.2250 MHz, where I caught retired radio broadcaster Art Bell (W6OOB), chatting with other hams in the Pahrump, Nevada area.

So here is a list of what I was able to log during my radio safari in southern Nevada. This list does not include all the trunked system frequencies listed above that were logged and monitored. Although there was plenty of military air traffic going on, I did not get to log all the active frequencies, but did write down a few;

118.3000, AM Crech AFB Tower  
 119.6750, AM DoE Mercury Airstrip AWOS  
 134.1000, AM DUDLEY 62 (UAV) inbound  
 Crech  
 135.1000, AM

138.3750, AM Air-to-air  
 139.9250, CSQ Crech AFB, alarm data  
 143.8250, AM Air-to-air  
 162.7875, N167 FBI  
 163.1250, N4CE Hoover Dam Police  
 163.2125, N100 Unknown agency  
 163.6250, N169 DHC ICE  
 163.7000, N169 DHS ICE  
 163.7500, N300 DHS ICE  
 163.8125, N167 FBI, input to 167.6625?  
 163.9125, N167 FBI, input to 167.2125  
 163.9625, N167 FBI  
 163.9875, N167 FBI  
 164.4500, 114.8 Possible US Postal Service truck operations  
 164.6250, 146.2 Unknown agency  
 164.6500, CSQ Secret Service TANGO, body wire on someone doing surveillance near my location  
 165.2375, 100.0 DHS CBP Net 1 - OTAR  
 165.2875, N650 BATFE NET 1  
 165.3750, N001 Secret Service CHARLIE  
 166.2375, 114.8 BLM, Mt. Charleston  
 166.2875, N002 TSA at LAS airport  
 166.3000, CSQ Bureau of Reclamation, Lake Meade  
 166.3750, 100.0 Unknown agency, mentioned Kingston Wash  
 166.4625, N001 TSA at LAS airport  
 166.7875, N293 Unknown dispatch with radio checks  
 166.9000, CSQ Lake Meade National Recreation Area  
 167.1250, 123.0 FBI  
 167.2125, N167 FBI (repeater on Mandalay Bay Hotel?)  
 167.2625, N167 Open carrier, with some P25 (N167) key ups  
 167.3625, CSQ FBI  
 167.4375, N167 FBI  
 167.6625, N167 FBI  
 167.7625, N167 FBI  
 168.0875, N002 TSA at LAS airport  
 168.1625 Unknown agency  
 168.5250, 107.2 USFS Weather Reports  
 168.6500, 110.9 USFS National Flight Following  
 168.4375, 114.8 Unknown agency  
 168.4875 Unknown agency  
 168.5250, 107.2 USFS Fire/Weather reports  
 168.9625, N001 TSA at LAS airport  
 168.9625, N002 TSA at LAS airport  
 168.9625, N003 TSA at LAS airport  
 169.3000, N001 TSA at LAS airport  
 169.4000, 186.2 USFS / BLM  
 169.5500, N930 Unknown agency  
 169.6625 Unknown agency  
 169.8000, 173.8 BLM  
 169.8750, 110.9 USFS Mt. Charleston with LAS VEGAS (USFS HQ)  
 169.9125 Unknown agency  
 170.0500, CSQ Lake Meade National Recreation Area  
 170.0750, D051 Possible ICE operations  
 170.1000, N300 Unknown  
 170.1000, NC03 Unknown  
 170.4750, 156.7 BLM, Mt. Charleston  
 170.6250, N167 FBI  
 170.6625, N167 FBI  
 170.6750 Unknown agency  
 170.7500, N293 US Marshals, Federal Court-house Security  
 170.8000, N293 Unknown agency  
 171.3625, 88.5 Unknown agency  
 172.3500 Unknown agency  
 172.6000, 173.8 Lake Meade National Recreation Area  
 172.6125, 156.7 Zion National Park South (analog)  
 172.6125, N637 Zion National Park South (digital)  
 172.7625, N301 Unknown, 14-xx units talking about heading to the office  
 172.9000, N001 DHS TSA at LAS airport  
 172.9000, N013 DHS TSA at LAS airport  
 173.2000, NCA6 Unknown agency  
 173.6750, N47C BLM - "700" & "BLM Radio Maintenance" testing on "GRASS" or "BASS"

173.9875, CSQ Data bursts  
 234.3250, AM Air tactical, COYOTE Area  
 243.2750, AM Crech AFB, approach?  
 281.0250, AM Blackhawk helicopter departing Crech AFB  
 288.2250, AM Crech AFB ATIS, mentioned 254.4 & 119.35 for Nellis Control  
 290.0000, AM  
 290.4500, AM  
 291.0500, AM Crech AFB Tower  
 327.8000, AM  
 360.6250, AM  
 361.0250, AM  
 367.4000, AM  
 377.8000, AM  
 406.9375 May be UAV Operations  
 407.3125, CSQ UAV operations at Crech AFB  
 407.5250, D023 Las Vegas VA Medical Center, TRBO digital mode  
 409.1125 Unknown, open microphone with PA in background  
 409.1875, 100.0 Unknown, conventional repeater  
 409.4000, N940 Unknown agency  
 410.1000 Federal Protective Service, Las Vegas  
 410.3000, CSQ Data bursts  
 410.9500, CSQ Data bursts, LAS airport  
 413.6000, 103.5 US Postal Service  
 413.8000, CSQ Data bursts  
 414.5250, 103.5 US Postal Service sorting facility  
 415.2750, 186.2 Unknown agency  
 415.5750, 186.2 US Postal Service, input to 418.1000  
 416.0000 Possible DoE paging  
 418.0000 Open carrier  
 418.1000, 186.2 US Postal Service truck operations  
 418.7500, 156.7 DEA F3  
 418.9000, 156.7 DEA F2, OTAR data  
 419.5000, 156.7 DEA, Las Vegas local operations  
 446.2250, 156.7 W7HTL amateur repeater - Pahrump area

As with the past logs of my road trips, I will post this on the *Fed Files* blog page and would welcome any corrections or additional information that others can provide.

## ❖ Scanning the Diplomatic Security Service, Part II

In the July *Fed Files*, I passed along the UHF federal channels that are frequently used by the Department of State Diplomatic Security Service. In addition to the UHF frequencies I published, there are some VHF allocations to the DSS. While I have only encountered them on UHF channels, these could be possibly be used in the US.

These VHF channels can be utilized by other State Department operations as well. I recall hearing reporters from the US Information Agency (The Voice of America) using 166.6125 and 169.6125 MHz while covering some past political conventions.

148.1000 149.7500 163.5250 163.5750  
 164.7000 165.6125 166.1000 166.2000  
 166.6125 168.0000 168.0500 168.2250  
 169.0500 169.1000 169.2000 169.6125  
 169.6250 169.7000 169.8000 170.4500  
 170.5750 172.7000 173.7375 173.9625

That's all for this installment of the adventures in federal monitoring. Be sure and see what is in store for the November *Fed Files*.



## Stepping Back

**L**istening to either the scanner in my car or the hand-held scanner that I carry with me when traveling helps me keep an ear out for railroad activities, even when they are not within visual range.

Yes, the scanners will often alert me to a particular switching move or to an approaching train, but more than that, what I listen to are the patterns that emerge when I listen to a particular railroad over months or even years.

While I enjoy seeing most any train roll by, I've found that over the years, I most enjoy understanding what the train is doing and how it fits into the over-all picture of railroading. Towards that end, I've often found that some of the best train-watching spots are not immediately at trackside, but sometimes some distance away, where it's possible to see more of the train and more of the activity at one time.

You may also find that sometimes stepping back actually lets you see more of what is going on.

### ❖ More on Multiple Units

In the last column's discussion of multiple units on a train, I ran out of space before running

out of concepts I wanted to present. So, let's finish up this discussion.

I mentioned that when there are multiple units on the front of a train, not all may be working. That can be for any number of reasons. The train may not need the tractive effort while in flat terrain or the units may be being delivered to another location for use there in a yard or on local freights. The units may also be on the way to a maintenance base for inspections and work that cannot easily be done in the field.

Non-working locomotives may be moved in one of two ways: isolated (off-line) but with the prime mover running, or "dead in tow" – sometimes abbreviated as DIT. A dead unit is simply another heavy piece of freight.

Starting a large diesel engine is not a simple procedure, so, more often than not, if a unit does not have a problem that would keep the prime mover (diesel engine) from running, it is moved with the prime mover idling. (Railroads use "prime mover" to reference the diesel motor itself, to differentiate from the term diesel engine, which can also refer to the entire locomotive.)

Diesel locomotives have a control switch on the back of their cab that has two positions, "Start/isolate" and "Run." The switch has to be

in the start/isolate position during that start-up procedure. In that position, the locomotive ignores commands from other units in the consist (sequence of rail cars), even if it is connected by MU (multiple unit cable). In the run position the locomotive works together with the other units.

A locomotive can be isolated at any time for fuel savings, for mechanical problems, or other reasons. A locomotive that has shut down can also be isolated, restarted, and then put back online even when a train is moving.

### ❖ Doubling and Tripling a Hill

We also looked at how helpers and DPUs (distributed power units or remote controlled locomotives elsewhere in the train) help get heavy trains up major grades. There is another old train handling technique that is still used on secondary lines. That is "doubling" or "tripling a hill."

If the train does not have sufficient power to make it up the grade, the train simply leaves half or a third of its cars at the bottom of the grade and proceeds up the grade with the remaining cars. When it gets to the crest of the grade, the first group of cars are left in a siding and "tied down" with hand brakes. The engines and crew then run light back to the bottom of the grade to pick up the next or remaining group of cars and then head back up again.

At the top of the grade, the train is then put back together to its original length and proceeds on to its destination.

Splitting and recombining the train as well as the multiple runs up and down the grade take a lot of time, which is why you would not normally see these operations on a busy main line. Doubling or tripling a hill also only makes sense if there is a relatively short major grade of a few miles. For much longer grades or a successive series of grades, it makes more sense to simply run shorter trains where the motive power can be matched to weight of the train and the grade.

### ❖ PTC Update

Major railroads are continuing to invest huge amounts of money to begin implementing the federal mandate requiring positive train control (PTC) on major lines that carry either passenger trains or hazardous materials.

But, the railroads are not happy. Every time I get a chance to talk to railroad officials involved in operations or technology management, I hear much of the same story, though usually off the



*Three large modern Norfolk Southern diesel locomotives are working hard to get a relatively short freight train of only about 50 cars up the major grade on the NS "S" line between Old Fort and Asheville, N.C. This view is from a backcountry road near the community of Graphite. In flat country, those same three engines would be able to move a train of up to 150 freight cars. This section of the S line is known as "The Loops" because the tracks twist back and forth through several valleys to gain altitude.*



record. The story they tell is that the technology still has lots of problems and costs way too much for what it *may* accomplish.

The PTC being installed by railroads is based in part on global positioning satellite (GPS) data. If you've ever tried to use a GPS-based navigation device, you know that there are areas where reception is a problem.

Another factor seldom discussed outside the railroad community is the fact that for parallel tracks, GPS is right at the limits of the system's level of resolution. On older lines, parallel tracks were often built on 15-foot centers. (That means that it's 15 feet from the center of the rails of one track to the center of the rails on the other track.)

Yes, railroads are aware that 15-foot center distances provide other problems for modern operations. Newer lines, where double-track is being installed for the first time, are built on 25-foot centers, where feasible.

A non-GPS related problem with 15-foot centers is that when maintenance work is being done on one of multiple parallel tracks, the adjoining track or tracks need to be shut down, too, for the safety of the track workers. Some of the track machinery (particularly the booms and counterweights of cranes, when they are turned) overhangs the outside rail by more than typical railroad rolling stock. When tracks are built on 25-foot centers, operations on parallel tracks can usually continue uninterrupted.

But, as you can imagine, any safety system that cannot tell on which of two parallel tracks a train is on is not particularly useful.

On the other hand, communicating the status of lineside signals to the engine of a train is a lot simpler. And, you will see PTC-related antennas being installed at many control points. (For routes that already use radio code line [RCL] with antennas at each control point, the new antennas may either be added to existing masts or installed on separate masts, depending on local conditions.)

The PTC system needs the GPS component of the system to tell where the train is in relation to a particular signal, to interpret what that signal means to the train. If the train is nearing (within a mile) an absolute stop signal, it needs to be slowing down or operating at very slow speed. If it is within a hundred yards of the stop signal, it needs to be stopped, or the system will enforce a stop and will not allow it to proceed until the signal has changed.

Under current operating rules, trains can normally move right up to a stop signal and stop there. But, crews also have latitude to stop well short of that signal, if local conditions warrant. That may include a road grade crossing right before or right past the signal. In the first case, the train will avoid fouling the crossing if it will have to wait at that location. In the second case, the train will try to avoid activating the crossing protection at the grade crossing past the signal.

Most modern grade crossings have "approach circuits" which not only detect approaching trains, but also the speed at which they are approaching. If the train stops short of the crossing, the circuit will time out and the grade crossing protection will clear. But, as all these systems are set to operate on the safe side, the grade crossing may still activate briefly before



*A few minutes later this same slow-moving NS freight is now high above the same back country road, on a kudzu-covered hillside, still working its way uphill. The photos were made on the way back from attending an Operation Lifesaver railroad safety meeting in Asheville earlier this year. My scanner alerted me to the approaching train (NS road channel, 160.950), making it worthwhile to pull off Interstate 40. I had made photos in this area over many years and already knew my way around the back roads.*

timing out and releasing.

Let's say that train A, which is to meet train B at a given location, is nearly as long as the siding at that location. The dispatcher has set up the meet so that train A heads into the siding and stops there, while train B will pass it on the mainline, once train A is completely in the clear.

Let's say that train A arrives at the meet location well ahead of train B, and has one of the grade crossing situations outlined above. It stops well short of the absolute stop signal, which leaves the back end of its train hanging out on the main line.

When it knows that train B is approaching, it pulls the last few hundred yards up to the signal, getting its rear in the clear, allowing the dispatcher to throw the switch at the other end of the siding and to clear the main line signal for train B. This type of situation happens more often than you might think.

But, under PTC, it raises all sorts of questions: Will the PTC system allow the crew of train A to restart their train and move it up those last few hundred yards? Or, will it require the crew to do some kind of override of the PTC system?

## ❖ **Override**

Any PTC system has to have some capability for an override, because there are situations where a signal system failure would otherwise totally tie up a railroad. In July of this year, I was on an Amtrak train that received verbal permission from the dispatcher to pass a problematic stop signal. The crew had to proceed at restricted speed until it encountered the next clear (green) signal. The dispatcher knew that there was a problem with the signal and that there were no trains in the block ahead. But, the train still had to operate "on sight" at slow speed through that block.

I've also traveled on engines in Europe on lines equipped with automatic train stop (ATS), a simple form of PTC. To avoid a penalty emergency brake application, the engineer has to acknowledge all restrictive signals – even signals that allow him to proceed, but at less than full authorized speed. And, of course, passing an absolute stop signal would immediately trigger a penalty application.

However, on these trips I've also seen situations where the engineer had to do an override of the ATS system to pass a stop signal – with authorization, of course. These overrides are documented on the locomotive's event recorder. And, whenever you can override or bypass a safety system, there is still the potential for human error.

Therefore, I am always troubled when news reports state absolutely that a given accident would have been prevented by a PTC system. A better way to put it would be that the accident *might* have been prevented by a PTC system. Even accidents in other modes of transportation often demonstrate that no safety system is absolutely foolproof.

## ❖ **PTC Mapping**

To implement a system with the complexity of what the government wants, not only does every foot of every track covered by that system have to be mapped for GPS location, but an enormous amount of programming has to be done to help the dispatching system apply that GPS data. The system has to be able to decide what train movements will or will not be allowed under a wide range of conditions. And all that programming is very expensive.

Next time: A look at more sources of railroad information, particularly on the Internet.



## The Future of Internet Radio Could it one day come at a cost?

I remember when I first started getting interested in Internet radio; it felt very wide open and free. It reminded me a lot of the days in our house before companies like DISH Network or DirectTV came along, when we moved between satellites with our large Ku and C-band dish to tune in programming.

Not just standard programming, mind you, from networks like TBS or HBO. No, I am talking all of the little minutiae of satellite programming that was at our disposal. Direct feeds from satellite trucks of news teams were readily available to anyone who knew where to look. You could watch reporters fix their makeup, rehearse lines and cut-up with the camera crew well before they went “live.”

Then, everyone started falling into neat little lines of organization. You had your big companies such as DISH and DirectTV that controlled the funnel of what channels you could access according to what you were willing to pay. It was inevitable, really. But I always missed that free-form feel of satellite programming.

Internet radio has had a similar feel up to this point. All you had to do was grab a streaming radio app or go to a web site and you too could tune in any stream you wanted to.

Now, broadcasters are lining up with specific partners in the industry, and before you know it, there will be subscription plans and other ways of controlling the content you can access.

Take for instance the announcement of a deal between Yahoo and Clear Channel Entertainment and Media (formerly known as simply Clear Channel Radio). Clear Channel has agreed to provide content from its “iHeartRadio” service to Yahoo’s digital radio service. Likewise, streaming service and smartphone app provider, TuneIn, has struck similar deals with Cox, Emmis and Entercom.



While there aren’t any changes happening because of this shifting just yet (you can still access Clear Channel stations through TuneIn, as an example), the writing is on the wall. Whether it be through exclusive content to certain providers (like NFL *Sunday Ticket* and DirecTV), audio quality, streaming data allotment or station availability subscription packages (imagine paying a premium to hear ESPN radio stations, as an example), there will most likely come a day when you will have to pay to experience Internet radio in the free-form and wide-open method you do now.

These media giants are still trying to figure out how to earn sustainable and significant revenue from streaming content. Advertising revenue is starting to creep up for online streams. In my market of Upstate South Carolina, I am hearing local advertisements on Pandora now. But don’t think for a second that radio companies or streaming providers won’t take a page from the book of cable TV or satellite radio. Expect to see subscription-based Internet radio in the not too distant future.

I can see something like a subscription-based sports package that also incorporates text message alerts with scoring updates and news. How about news coverage? How about music formats? Would you pay \$5 per month to be able to hear only stations of a certain music genre you enjoy? How about \$10 per month for unlimited music streaming? How about an extra \$5 per month to tune in international stations, or for high-quality audio?

If I have learned anything about technology over the years, is that at first, it is great. It is open and free and carries unlimited potential. But once people figure out how to make money off of it, access becomes more limited and measures of control increase. One need only look at the data plan offerings of cellular providers to see what I am talking about.

I really hope that none of that comes to pass. I am hoping the Internet makes streaming radio immune to the ability for this type of business model. But, the more I see companies maneuver and align, the more clearly the writing appears on the wall. So, enjoy the freedom and opportunities of choice while you can. Tuning in your favorite stations may someday mean digging a little deeper in your wallet.

### ❖ Clear Channel agrees to Performance Royalty?

In more Clear Channel news, they have reached a deal with Big Machine Records – the country music label that includes artists such as Tim McGraw and Taylor Swift – to pay out royalties on a per-performance basis.

After the National Association of Broadcasters fought pretty strongly against these performance royalties when the Recording Industry Association of America made a push for them to be implemented industry-wide a few years ago, now Clear Channel has gone out on their own and brokered this deal.

At first, I was puzzled why Clear Channel finally caved in and agreed to performance royalties after claiming for so long that the extra costs of doing so would put an already strained industry on the verge of complete collapse. But after reading the rest of the article and giving it some thought, I realized what they were trying to do. Basically, it all comes down to Internet radio.

Sometime in the last few years, Clear Channel finally realized that the Internet wasn’t going away. They realized that as smartphone usage and broadband accessibility increases, more and more people want to use the Internet to take their radio stations and music with them wherever they go.

As they are making a strong push right now to expand and move towards an ever increasing online presence, they saw this deal with Big Machine Records as a chance to give their online presence a chance to grow by reducing the royalty burden for online streams.





## ❖ How? Let's take a look

Remember when the recording industry brokered the performance royalty for Internet radio stations? Instantly, Clear Channel and other broadcasters had to start paying a per-song royalty for all stations streamed online – but not for their over the air broadcasts.

When the recording industry (and Internet-only folks like Pandora) started screaming for broadcasters to pay performance royalties for over-the-air broadcasts as well, the broadcasters fought back. Under that setup, they would be paying performance royalties twice for playing a song once (once for over-the-air and once for the stream).

With that model, there is no cost benefit for doing anything online. Under this new deal, however, Clear Channel has negotiated that, rather than pay a per-performance royalty for online streams to artists on this label, they will pay a percentage of their revenue from the streams. So, they pay the standard ASCAP/BMI royalty payments for copyright holders, per-performance royalty for the over-the-air broadcast, and then a percentage of their advertising revenue from streaming and that's it.

Under this model, online streaming suddenly becomes a much more lucrative avenue to explore. Clear Channel basically met the record label in the middle.

Will this type of royalty deal become standard across the industry? If it is negotiated on a per-label basis with each broadcasting company, I doubt it. Big Machine Records has some pretty big names on their bill. A smaller record company likely won't even get a second glance from the broadcasters.

That is exactly what Tim Westergen at Pandora and members of the record industry are saying. They want Congress to step in and create a uniform royalty system that forces broadcasters to apply this type of royalty deal across the board.

Will it happen? I think it is certainly more likely, now that Clear Channel, the largest radio company in the world, has agreed to it with one label. It will bear watching over the next couple of years, to see how this pans out. In the end, though, all of this should be a great way to even the playing field for Internet radio, which is always a good thing.

## ❖ Shortwave Ver. 2.0?

I stumbled upon a short UPI article recently that made me rethink my stance on the exodus of broadcasters from shortwave to the Internet.

So many people are lamenting the loss of shortwave broadcasters to the Internet and bemoaning that the radio hobby is dying, that it has almost become a cliché. I haven't bought into the second myth, because I know that there will always be a need for someone to broadcast information to remote areas of the world via radio waves.

My original stance was that if you are someone who turns to shortwave radio for the programming content, you should actually be thrilled to hear it streamed. No more poor conditions ruining your chances of hearing that content. Now, through the Internet, you have

access to crystal-clear signals no matter what the atmosphere is doing.

If you are someone who is more interested in the thrill of the chase of rare signals and DX, my response has always been, "get your amateur radio license; there is far more you can chase down as a ham than you ever could as a pure shortwave listener."

Growing up in the Van Horn household, I have heard countless times my shortwave DXing mother being disgruntled when my father – a QSL-hunting ham – had snagged yet another country that was unavailable on shortwave radio. So, I have always looked at ham radio as a DX option with far more potential – even before there was an Internet. So perhaps I actually did buy into the notion that the Internet had killed shortwave DXing, even though I hadn't come right out and said it. But now, I see the error of my ways.

Rather than killing shortwave DX, I think that the Internet will help shortwave radio go through a "reboot," so to speak. To illustrate, let me give you an example from my favorite form of DXing, mediumwave.

## ❖ Sometimes Less is More

When I was hot and heavy into nightly forays of mediumwave DXing, I would often find myself parked on a frequency occupied by a large "clear channel" (not the company) 50,000-watt behemoth. These, for me in my location, were usually flamethrowers on the East Coast such as 770-WABC, or 720-WGN or 1030-WBZ. The frustrating part was that on the opposite side of the country – on the same frequency – was another flame-thrower of a station that I would never be able to hear because of the monster on the East Coast.

My father used to tell me stories about when he would DX the AM bands in the '70s, and these large stations would go off-air at times on late Sunday nights/Monday mornings for transmitter maintenance. He told me that is when he was able to snag so many stations he otherwise never could.

So, night after night, I would stop by these frequencies, hoping against hope that maybe they would be taking a break from broadcasting so I could pull in the faint signals of stations like 770-KKOB in Albuquerque; 1030-KTWO in Casper, Wyoming or 720-KDWN in Las Vegas.

Circling back now to the article that spawned all of this: The UPI article discusses how, as major international broadcasters are abandoning shortwave in favor of the Internet, the gap is being filled in with smaller broadcasters trying to reach remote parts of Africa and other parts of the globe.

Think about it. The Internet isn't available everywhere across the globe yet. Even in some of these remote places where it is available, the connection isn't reliable, the electrical grid is even less so, and many of these countries censor what their citizens can access through the Web.

So, what alternative do they have for accessing information? That's right, they are pulling out their old battery-powered shortwave radios and – surprise, surprise – still finding stations to tune into.

My favorite form of shortwave DXing was always hunting down "the tropics." Trying to pull in smaller stations on the low bands from Africa, South America and the South Pacific was far more challenging and gratifying than pulling in a QSL from BBC or Radio Netherlands. Anyone can do that.

Now, with those flamethrowers disappearing, there is more room for the real gems of DX to shine through.

If you want to hear Radio Canada or Deutsche Welle, they are still there waiting for you online. But if you want to get your hands dirty with some really good DX, don't throw away your shortwave radio just yet!

I think we are in the middle of a reboot and renaissance for shortwave radio version 2.0, which will give DXers a whole slew of new DX targets to choose from.

Until next month, 73 and happy listening!

## GLOBALNET LINKS

Clear Channel First to Pay Royalties for Music On-Air - [www.npr.org/blogs/thercord/2012/06/13/154871444/clear-channel-will-be-the-first-to-pay-royalties-for-music-on-its-air](http://www.npr.org/blogs/thercord/2012/06/13/154871444/clear-channel-will-be-the-first-to-pay-royalties-for-music-on-its-air)

Radio Royalty Deal Offers Hope for Industry-wide Pact - [www.nytimes.com/2012/06/11/business/media/radio-royalty-deal-offers-hope-for-industrywide-pact.html](http://www.nytimes.com/2012/06/11/business/media/radio-royalty-deal-offers-hope-for-industrywide-pact.html)

Shortwave Radio Not Lost to Internet - [www.upi.com/Entertainment\\_News/TV/2012/07/07/Short-wave-radio-not-lost-to-Internet/UPI-86811341670760/](http://www.upi.com/Entertainment_News/TV/2012/07/07/Short-wave-radio-not-lost-to-Internet/UPI-86811341670760/)

## GRACE Wi-Fi Grace GDI-IR2600 Innovator X

- Listen to over 50,000 Radio Stations,
- Podcast, and on demand content
- Supports online music services:  
Pandora, Live365 and PREMIUM SiriusXM internet radio
- Compatible with the Grace iPhone™ / Touch remote control application
- 4 line high contrast backlit display
- Displays Station, Song Title & Artist info
- Full function remote w/ 10 presets
- 10 presets on the radio + 99 station folder



Order DS-IR2600

\$139<sup>95\*</sup>

\* plus \$19.95 UPS  
Ground or Priority  
Mail shipping

## GROVE

800-438-8155  
828-837-9200  
fax: 828-837-2216

order@grove-ent.com  
7540 Highway 64 West  
Brasstown, NC 28902

[www.grove-ent.com](http://www.grove-ent.com)



## Summertime, Summertime

Welcome to another issue of *Below 500 kHz*. I trust that readers in the northern hemisphere are enjoying a warm summer season. Longwave conditions are typically not at their best during the warmer months, as static crashes often win out over desired signals. However, there are still days that can surprise us, and if you're willing to do some listening before 10 a.m. local time, things can be especially productive. At these times, there is still some nighttime skip in effect, and static levels have not yet had a chance to build up. Soon, fall will be on its way with lower static levels, but for now, coping strategies are the key to success.

If chasing beacons is your thing, but you don't want to battle with static, consider taking a respite and hunting for beacons elsewhere in the radio spectrum. Both 10 and 6 meters are favorite bands of mine and have been fairly productive this summer at my location in Western NY. An online search for beacons on these bands will give you plenty of targets to try for.

A few years ago we had a new roof put on our house, and most of my antennas had to come down. It has taken me until this summer to finally get them re-installed with proper grounding, cable routing, rotor control, etc. It didn't help that when lowering my 6m beam to the ground, the roofers dropped it from about 15 feet up, damaging several elements. To fix it, I slid pieces of slightly larger aluminum tubing over the broken pieces, forming a sort of "splint" to hold things together. This, along with a few sheet metal screws got things back in order. It's good to be back on 6.

### ❖ Summer Mailbag

**John Leonardelli, VE3IPS (ON)** writes: "Hi Kevin, I plan to build the VLF Natural Radio receiver featured in your March 2006 in your column. Was there any erratum to the design? I thought perhaps there was a mistake in the schematic but can't find the issue denoting it.

Hello John, the March 2006 issue described the construction of the Bare Bones Basic BBB-4 receiver, and the April 2006 issue had the conclusion. There are some useful tidbits in the second column on buttoning up and using the receiver for the first time, so I recommend reviewing that, as well.

There are no error corrections on the published circuit, but I do describe a wiring error I made in my own construction. I accidentally hooked C8, the output coupling capacitor, to a ground point instead of Q2's collector. It was an easy mistake to make, but the circuit definitely would not have worked this way. The moral: double-check everything! Good luck in building the BBB-4, and please let us know how it works.

Most readers have heard of the interesting work being done by the Maritime Radio Historical Society (MRHS) in California, including the reactivation of longwave and HF transmitters for ship-to-shore communication. John was kind enough to send along some photos he took of the station during a visit there. They are shown below. For more information on MRHS, visit their interesting website at: [www.radiomarine.org](http://www.radiomarine.org).

**Cary Norman, N6SQ**, writes: "I am puzzled in that although I have several 60 kHz

WWVB clocks that sync up just fine, I am unable to detect the carrier at 60 kHz on a receiver. My receiver is an Icom IC-746 which tunes down to 30 kHz and works well. I use a 100-foot long wire for LF and I can receive many LF beacons. I would think that in CW mode I should at least hear the carrier being broadcast. Do you have any thoughts on this? Thanks, and by the way, I read and enjoy your column in *MT*."

Hi Cary, and thanks for writing to *Below 500 kHz*. I'm at a loss to explain why you wouldn't be able to hear the WWVB carrier at 60 kHz. It's moderately strong here in NY, and I assume from your "N6" callsign that you are closer to the station than I am. Are you seeing any signal at 60 kHz (even static) that registers on your S-meter?

My only guess is that ambient static is covering up the time signal when using a wire antenna, while the small ferrite antennas inside your clocks are less responsive to ambient noise and tuned specifically to the 60 kHz signal. Please keep us posted on your progress.

**Jim Moodie, KA7CIC (OR)** writes: "Hi Kevin, in the next few months I would like to search the area hamfests for a good older ham transceiver – one with above average specs for longwave. I want to start chasing NDB's with better equipment than I presently have. Can you help me out with any model number suggestions?"

Hello Jim, Glad to hear of your interest in "taking things to the next level" in chasing beacons! While you can get started with just about any old receiver, you soon see how much better you could do with more advanced gear. The trouble with older ham transceivers is that many do not cover much below 1.8 MHz.

One older rig that does cover longwave is the Kenwood TS-430/440 series, which goes down to 150 kHz on receive. I have known several LW DXers who use these sets with good success.

Another option is to use a *receiving converter* in front of a ham transceiver. You get all the features of the ham rig (filters, noise blanker, S-meter, digital readout, etc.), but the converter moves the LW band to a range the rig can tune, such as 3.5 to 4 MHz. Just be certain you never *transmit* into

*Views of the station and antenna farm at the Maritime Radio Historical Society (MRHS) station at Point Reyes, CA. (Photos courtesy of John Leonardelli, VE3IPS)*





the converter or it will probably be damaged. Whenever I have used one, I disconnect the mic and key just to be extra safe.

Hope this gives you a few pointers and good luck in hunting for that special rig!

**Kriss Larson, KR6ISS**, enjoys traveling to interesting destinations worldwide, and he usually manages to work in some time to visit radio sites – specifically longwave sites. We are pleased to hear from Kriss once again, this time with a summary of his trip to New Zealand...

“Just came back from another foreign trip, this time to North Island, New Zealand and Norfolk Island, primarily out of my interest in oceanic island botany. Visited several rainforests-complete with rain – it has been an unusually rainy summer down there, good for farmers, but not for tourists.

“I did my usual band scans from 0-500 kHz in a few places. One especially good scan was done on Norfolk Island, which is 800 miles north of New Zealand; about 5 miles square, and is famous for its Norfolk Island Pines and home of some *Mutiny on the Bounty* descendants. On Norfolk, since it is an official DXCC radio country, I made an effort to find a resident ham to get a chance to make contacts on the air, sort of a pseudo DXpedition from a remote island.

“I did find such a person on Norfolk – John Anderson, VK9JA – who has been on the island for 65 years, but not that active a ham. The well-known ham of Norfolk, Jim Smith, VK9NS, died in 2009 and the island has had little traffic since.

“We did get on the air on John’s limited equipment for a few sessions. The most distant

**TABLE 1. SELECTED NDB LOGS FROM NJ**

| kHz | ID   | St/Prov | City              |
|-----|------|---------|-------------------|
| 391 | OGY  | NY      | NEW YORK          |
| 390 | FR   | NY      | FARMINGDALE       |
| 396 | NEL  | NJ      | LAKEHURST         |
| 363 | RNB  | NJ      | MILLVILLE         |
| 275 | BBN  | NY      | BABYLON           |
| 254 | CAT* | NJ      | CHATHAM           |
| 254 | EUD  | PA      | YORK              |
| 248 | IL   | DE      | WILMINGTON        |
| 349 | APG  | MD      | ABERDEEN PVG GNDS |
| 216 | CLB  | NC      | CAROLINA BEACH    |
| 208 | UKT  | PA      | QUAKERTOWN        |
| 369 | TT   | NJ      | TRENTON           |
| 328 | BZJ  | PA      | INDIANTOWN GAP    |
| 335 | SW   | NY      | NEWBURGH          |
| 388 | RNW  | NC      | CHOCOWINITY       |
| 379 | BRA  | NC      | ASHEVILLE         |
| 366 | YMW  | QC      | MANIWAKI          |
| 360 | PN   | QC      | PORT MEYER        |
| 340 | YY   | QC      | MONT JOLI         |
| 281 | HP   | NY      | WHITE PLAINS      |

\* Occasionally miskeying with variations on this ID.

QSO was a guy in the Ukraine 9700 miles away, and the other direction to a guy in Pennsylvania at 8500 miles. We also talked to a couple of guys in Southern California near my home. It was fun to be on the receiving end of a DX pileup for a change!

“Anyway, I found John, who is 74, to be an interesting guy – he was the radio technician on the island for many years. One of his many assorted duties was maintaining the NDB, which he said used to be 3000 watts. The present one was no slouch either – I heard it strong in broad

daylight 1000 miles away in the west coast of North Island, New Zealand.

“What was off the air was Lord Howe Island’s beacon – I visited that island in 2006 – another barn-burner transoceanic. The big catch from Norfolk was Majuro Atoll in the Marshall Islands in the North Pacific-2500 miles away (MAJ/316 kHz). That must be a particularly strong transmitter.

“Australia has a string of DGPS beacons, while New Zealand has none. Neither New Zealand nor Australia supports 518 kHz NAVTEX for some reason. Even though it was summer down there and there was a full-strength hurricane going on in Fiji while I was on Norfolk, static noise was not strong – very different from the US in the summer. Anyway, it was another successful trip – although a bit wet. My next trip in July is Croatia-Slovenia. A folklore trip that time – but the radio gear will also be in the suitcase!”

### ❖ Loggings

Our loggings this month are from Mario Filippi, N2HUN (NJ). He uses a Ten Tec RX 320D and a Yaesu FT101 ZD receiver with a Palomar VLF converter. His antenna is an S9 43-foot vertical with 53 ground radials.

Mario reports that some of these stations were readable for only a minute or two, before fading into the noise, so it paid to keep the headphones on and keep spinning the dial! Mario made three entirely new loggings in this way: BBN, SW and PN. The loggings are shown in Table 1.

That’s it for this month. See you in October!

# BOB’S BARGAIN BIN!

## Ready to trade up?

Bob’s Bargain Bin is a busy place! Our clients are always looking for good deals in used equipment, and you can save big bucks trading in your used gear for new equipment! EMail or give us a call now and we’ll let you know how much you can save on that new radio!

<http://www.grove-ent.com/bbb.html>

[order@grove-ent.com](mailto:order@grove-ent.com)

800-438-8155

828-837-9200 fax: 828-837-2216

WWW.GROVE-ENT.COM







## Finishing up the Arvin Project

### ❖ Last Month's Impasse

We concluded last month's column with an impasse. Normally I would have started the Arvin restoration with a complete recapping. However, one look at the crowded wiring under the tiny chassis convinced me not to make the attempt. The set must have been originally wired in layers and it looked like I might have to remove several capacitors and other components to begin changing out the capacitors in the bottom layer. This would be tantamount to inviting Murphy's Law into the project and giving it free rein!

I decided, instead, to proceed as a radio service tech would have done back in the day. In other words, turn the set on, look at the symptoms, and make only the specific repairs called for in the diagnosis. However, in view of the fact that we are dealing with a radio over 60 years old, I would start up the set gently using an autotransformer power supply that would allow me to increase the line voltage in four gradual steps.

While increasing the line voltage, I made sure there were no serious shorts by continuously monitoring the set's B plus to make sure it was rising to the expected value. There were no problems with the B plus, nor did I spot any smoke or notice the smell of something overheating. However, as soon as the voltage had risen to the point where the set could begin functioning, a problem became apparent. It was a loud raspy hum unaffected by the volume control – the typical symptom of an open filter capacitor.

The Arvin was equipped with the usual multi-section electrolytic capacitor containing two sections for filtering (40 uf and 20 uf at 150 volts) and a third (20 uf at 25 volt) as the cathode bypass for the 50L6 power amplifier.

I didn't have a multi-section with the right electrical specs that would fit into the small space available, nor did I see anything suitable available new. So, I ordered three individual electrolytics with the proper specs. Given the compact size of modern capacitors, I was reasonably sure that I would be able to find enough space for them under the chassis. Further work on the Arvin would have to await their arrival.

### ❖ Installing the Electrolytics

Installing three individual electrolytics in place of a single multisection unit presented an immediate logistical problem. The multisection capacitor had a single common negative lead, but

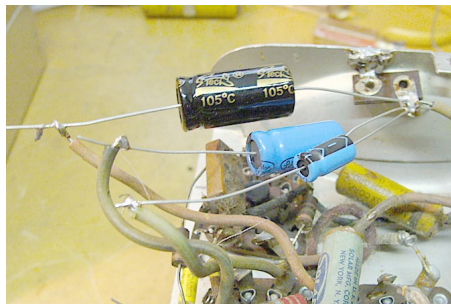

*Temporary installation of electrolytics allowed room for possible additional diagnosis and component replacement.*

now we had to deal with three separate leads. Ordinarily, this would be no problem. In most receivers, the leads would be grounded to the chassis, where there are usually plenty of available ground points.

However, this radio (see July column) has a "floating ground" for protection against electric shock – as would be mandatory for a metal-cased a.c.-d.c. radio. Opportunities to hook up to it are limited, particularly in the tight wiring of this midget receiver. The solution was to solder-mount a single-terminal lug to the stub of the metal strap that had once held the original electrolytic. The original common negative lead, still wired to the floating ground, was then clipped off close to the electrolytic and wired to the lug – leaving plenty of room for the negative leads from the three new capacitors.

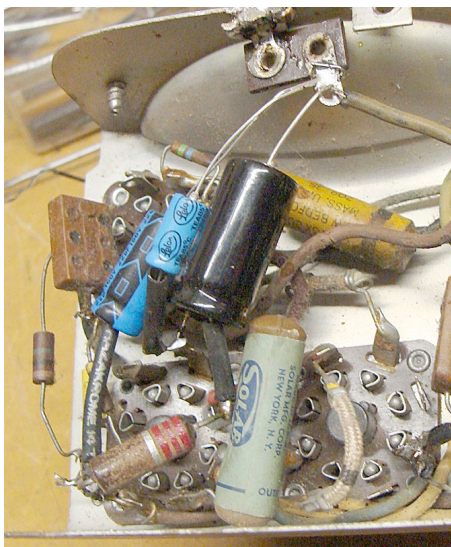

*Once proper operation of the radio was verified, the electrolytics were installed permanently.*

However, it was decided not to wire the three new caps permanently in place at this time. The reason: if the replacement capacitors did not entirely solve the problem, further troubleshooting would be required. A tight installation of the three new units would likely block access to components that would need to be tested during additional diagnosis.

Accordingly, the capacitors were installed without cutting their leads. The negative leads were slid partway into the lug that had been prepared for them and tack-soldered without crimping. The positive leads were tack-soldered to the clipped off leads of the original multisection unit, which had been left connected to the circuit at their other ends. This way the new capacitors were properly wired to the radio while leaving plenty of room for testing or component replacement.

Next, I attached a short length (about ten feet) of antenna wire and turned the set on. I had my fingers crossed – hoping that there would be no need for extensive probing and testing in the tangle of under-chassis wiring. And I got lucky! I was now able to pick up stations at several positions of the tuning capacitor.

However, even though hi-fi reception could hardly be expected, I thought I detected an "edge" in the audio quality that shouldn't be there. Suspecting a leaky coupling capacitor (C8 in Figure 1), I measured a bit over a volt of d.c. on the control grid of the 50L6 output tube – confirming at least some leakage. Luckily, C8 was quite accessible and I noticed a small but definite improvement in audio quality after changing it out.

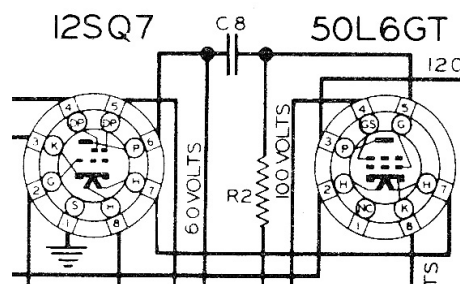

*Fig. 1. Leakage through coupling capacitor C8 caused slight deterioration of audio quality.*

After that, it looked like no further troubleshooting was going to be necessary, so the leads from the original electrolytic were removed and three new electrolytics were connected directly into the circuit.



## ❖ Alignment

Alignment of the little Arvin goes quite quickly, because there are a minimum of adjustments to be made. Since there is no i.f. amplifier stage, there is only one i.f. transformer instead of the usual two. The radio is also missing the usual antenna stage trimmer and low-frequency padder.

Alignment begins in the usual way by feeding a 455 kHz signal into the front end of the receiver and adjusting the i.f. trimmers for maximum output. In my case output was measured with a VTVM connected across the speaker voice coil and set to a low volts scale.

Usually with a long-dormant receiver like this, tweaking the i.f. trimmers leads to a dramatic increase in signal strength, requiring more than one reduction of signal generator output to keep from activating the AVC circuit. In this case, though I was able to obtain definite peaks, there was no such dramatic increase – probably because of the absence of an i.f. amplifier stage.

With the i.f.s adjusted, the signal generator is reset to 1400 kHz and connected to the receiver's antenna through a .00005 uF capacitor. The main tuning capacitor is also set to 1400 kHz and the oscillator trimmer is adjusted as the tuning capacitor is rocked back and forth on either side of 1400 kHz until maximum output is obtained. This dual adjustment is necessary to obtain good tracking of the antenna and oscillator stages in the absence of a specific antenna trimmer.

Figuring out how to carry out this operation had me briefly scratching my head because the oscillator trimmer is on the main tuning capacitor and is only accessible with the radio out of its cabinet. On the other hand, the tuning dial, which shows the position of a pointer knob attached to the shaft of the main tuning capacitor, is mounted on the cabinet front and is usable only when the set is in its cabinet.

However, the service notes tell us that the pointer knob should be set at 54 with the capacitor fully closed. After securing the knob in that position, it could be turned to the 1400 position and then carefully removed without further turning of the shaft. The set could now be removed from the cabinet and the adjustment could proceed.

After these adjustments were made, I tried the set again and noticed a definite improvement in liveliness as I tuned across the band. There were more stations coming in at higher volume.

## ❖ Cabinet Cosmetics

I was about to call this section "Cabinet Restoration," and it was my original intent to do something worthy of that name. But in the end I decided not to prepare the cabinet for painting and spray on a new coat. Why? Well, you could certainly call me lazy with some justification, but I also have some solid reasons.

For one thing, I found that going over the surface with some Ajax and a ScotchBrite pad worked wonders in removing the many rusty looking spots that dotted the surface. The treatment dulled the paint, but rubbing with Brasso metal polish restored a nice sheen.

The result was so encouraging that I took



*Now in good working condition the Arvin makes a nice appearance despite its scratches.*

the cabinet down to the Home Depot paint department, where they color-scanned it and mixed up a sample sized jar (maybe a half-pint) of matching paint. Cost: three bucks!

When I got the paint home and tried it out, I found that, though close in color, it couldn't be used to touch up scratches on prominent flat surfaces. It stuck out like the proverbial sore thumb. On the other hand, it worked very well in corners and half-hidden shaded areas and, of course, on the bottom, which was badly scarred and discolored.

When I had finished with all this, I ended up with a credible-looking cabinet that – to be sure – had some scrapes, but it also had more than 80 percent of its original finish intact. A couple of issues left unresolved are the knobs and back. The knobs are certainly the right color, but they don't match those in any pictures I've seen of these little Arvin sets. As for the back, I had been planning to make a fiberboard replacement, but once I saw a picture of the real back, I gave up the idea.

I'm including the picture with this article, and you can see that the louvered metal design couldn't even be approached in any amateur workshop. The back isn't really needed for safety reasons – so I'm just going to live with the set as is unless I'm lucky enough to come across an exact replacement.

## ❖ Polarized For Safety

I was just about ready to put the little Arvin away and begin thinking about what might be the next project for the column, when I had a sobering thought. While it's true that the floating ground system prevents dangerous line voltage from appearing on the cabinet and other metal surfaces of the radio, it does happen to be bypassed to the chassis via a .05 uF paper capacitor. Since I had not done a complete recap, the 60-year-old capacitor is still in place and



*The Model 444 back as seen on another radio.*

could let go at any time. If it did, the chassis and cabinet could easily become hot to ground.

My first thought was to replace the capacitor, but it turned out to be one of the buried ones. So I fell back on plan B. The radio was wired so that one side of the line was connected to the floating ground when the power switch was turned on. Searching through my collection of line cords, I located one with a polarized plug. Removing the line cord I had installed at the beginning of this project, I substituted the polarized version, wiring it so that the wire from the wide blade of the plug was the one that would become connected to the floating ground.

Assuming that the radio is plugged into a properly wired outlet, the wide blade of the plug will be connected to the grounded side of the line rather than the "hot" side, and thus would not present a shock hazard even if connected directly to the Arvin's metal chassis.

## ❖ From The Readers

**Joe Erickson**, N8PMF (Cadillac, MI), writes that he really enjoys "Radio Restorations," especially the articles dealing with military gear. He recently acquired an impressive Simpson 315 signal generator at a hamfest, but finds that the modulated r.f. output function does not work. He's looking for a schematic and/or a manual and would appreciate any help he can get. I've tried my usual source "Boat Anchor Manual Archive" (BAMA) at <http://bama.edebris.com>, but the 315 is not listed. Any ideas? Contact Joe through this column c/o Marc Ellis.

**Sandy Geiger III** (Rogersville, TN) enjoyed the first installment of The Arvin Model 444 restoration (July issue). He has a 4-tube Model 444 like mine, but in chocolate brown and also has examples of 2-tube and 3-tube Arvins. The 2-tube version is a Model 38; the model number of the 3-tube is unknown. But the Arvins are just a sideline for Sandy. He has a stunning collection of military, ham and commercial boat anchors, as well as antique broadcast receivers and sets in other categories too numerous to mention.

Join the **AWA**  
**ANTIQUÉ WIRELESS ASSOCIATION**  
THE ORIGINAL AND LARGEST HISTORICAL RADIO-COLLECTOR GROUP

- Publishes *AWA Journal* with:
  - Battery and AC receiver restoration
  - Vacuum-tube history and collecting
  - Old-time amateur-radio contests
  - Communications receivers
  - Free want-sell-swap ads
  - Early television
  - Horn loudspeakers
  - Reviews of current books
  - Keys and land-line telegraphy
  - News of U.S. and foreign clubs
  - Information on public radio museums
- Maintains unique radio-TV museum.
- Produces the annual Rochester meet.
- Co-sponsors local meets.
- Publishes the annual *AWA Review*.

Membership is only \$25 per year U.S.A. (\$30 per year elsewhere). Write to:

**AWA Membership Director**  
PO Box 421, Bloomfield, NY 14469-0421

[www.antiquewireless.org](http://www.antiquewireless.org)





# Receive-Only Antennas A Shortwave Listener's Perspective

**W**elcome back, my friends. This time around, let's take a look at antennas from a non-transmitting perspective – the viewpoint of SWLs and other listeners. Note well that neither club is exclusive of the other: I've been a ham since 1971, but I've been an SWL since 1968! Indeed, many of us started as SWLs, got the bug, and went on to get a license.

I have no doubt that many of you licensed hams still love to just *listen* to your favorite shortwave broadcasters and other services on the HF bands. I know I still do, even though I also operate the HF ham bands frequently. But a lot of other hobbyists are perfectly content to remain SWLs, and derive tremendous enjoyment from it.

When the requirement to be able to transmit is removed, the concept of *antenna* suddenly becomes much more flexible. For example, many a portable shortwave receiver has a short, telescoping whip antenna that is very compact and can serve as an acceptable receiving antenna under the right conditions.

I would not recommend trying to feed 100W from an HF transceiver to it, though – it's far too small for even the best tuner to match it, and the portable's RF circuitry wouldn't like it much either.



Typical whip antenna-equipped portable receiver. (Courtesy Kaito via Grove catalog)

Why the huge dichotomy? Because an antenna system *has* to get fairly close to an impedance match to allow *transmission* – modern rigs simply “fold back” and refuse to make any real power if the mismatch is at all bad, say 2:1 SWR or worse. An unmatched *receiving* antenna, on the other hand, merely generates a smaller *received signal*, which does not affect the radio in any deleterious way. And quite often, a tuner or preselector can maximize the *receiving* results very nicely, even though

the antenna in question is too small or short or low to the ground to load up as a *transmitting* antenna.

### ❖ Overkill for the SWL

Right away this principle imparts freedoms to the SWL that the ham doesn't have. Oh, I suppose the SWL *could* erect a 100 foot tower with a three-band beam cut for his/her three favorite shortwave bands; but the ham is more likely to feel that the beam and tower is a *necessity* to get the great DX, while it would certainly be ostentatious overkill for the SWL. Admit it, fellow hams – we want the beam primarily so we can inject our own transmitted signal into these DX areas, not because we're convinced the beam's *receiving* qualities are indispensable. (I'm sure we hams all have great stories to tell of the rare DX that we could hear fine Stateside, but for some reason they didn't seem to hear us.)

Sure, the beam is an excellent receive antenna – but so are many others that don't begin to require the expense, labor or complexity of the beam on a tower. In fact, the tower and beam are the very antithesis of *stealth*, which is a crucial issue for many nowadays, and is often easier for the SWL to implement since he/she doesn't have to transmit with any given antenna.

### ❖ Stealthy Listening Solutions

One elegant solution is the ever-popular *active antenna*, which generally takes the form of a small loop or whip antenna integrated with an amplifier and various tuning/preselecting provisions. These usually run on nine volt batteries and/or a wall wart, and are handy enough and effective enough that they have given many SWLs a quite acceptable substitute for the large outdoor antenna that they can't have, due to any number of obstacles, from pesky neighborhood associations (or as I always call them in this column, the Antenna Gestapo), to lack of real estate, to spousal objections.

It's a neat little idea, really, the active antenna – the amplifier greatly boosts the small received signal, while the very small receiving element is, hopefully, too small to pick up excessive noise, and simple turning or repositioning of the loop or whip can often null out a noise source or home in on a desired signal. Grove Enterprises sells a fleet of excellent active antennas, which I invite you to check out at [www.grove-ent.com](http://www.grove-ent.com). Another perennial antenna solution for the SWL



The AOR LA 390. (Courtesy: AOR via Grove catalog)

is the random wire. Here again, many configurations that would be too short or too low to transmit with work out fine as receiving antennas. (I well recall that many receiver projects I built in the 1960s called for “a wire 25 to 50 feet long, with the far end as high as possible” for the antenna. Definitely not a resonant length!) We can run the wire around corners, into trees, draped across the roof, hung in the attic, across the living room ceiling ... and have a workable SWL antenna.

Of course, a tuner will maximize results with this “random random” setup; and it will be seen that, without the requirement to be able to load up and transmit, some really short, low, or obstructed wire lengths will make excellent antennas. It's not the world-beater that the beam and tower is, but it is also nowhere near as expensive – or as visible.

One of the great legends of our hobby is the success folks have had using metal rain gutters as an antenna. It's no fairy tale, folks: I used to live in a three story house where I used the second floor guttering as a random antenna. It got me on the air on every HF band, and I actually worked quite a bit of DX. The trouble with the gutter as a transmitting antenna is that it's hard to rig an effective ground to work it against when your station is on the third floor! A counterpoise wire for each band helped some, but at 100 watts the gutter was often a vicious





Courtesy MFJ Enterprises

**Another popular active antenna, the MFJ 1020C.**

beast, as stray RF sprayed everywhere, giving me cute little burns every time I touched key, mike, knobs, or table edge.

On receive, however, the gutter worked very well. Apparently, that 100 feet of guttering around the second floor eaves and the four 20 foot downspouts connected to it constituted quite a bit of "capture area" for weak and exotic signals. I well recall the frustration of clearly hearing stations in Sudan, Kampuchea, or Antarctica, but being unable to transmit to be heard by them, due to loading or stray RF issues. When I would spin the dial on the SW broadcast bands, the gutter pulled in choice DX on every band.

And here's the real beauty of the gutter antenna, friends – it's already been paid for, built, and installed, and it's the ultimate in "stealth in plain sight"! Many have had good results simply attaching a single wire to the guttering at a convenient point; others opt for a run of coaxial cable to the bottom of a downspout, with the center conductor tied to the gutter and the braid tied to ground rods or other grounding

provision. Again, pretty "iffy" for transmitting, but likely to work very well as a receive antenna.

**Use Your Imagination**

Once we free ourselves of the necessity to transmit, we start discovering that just about any metal surface is a potential receive antenna. I have reeled in a ton of great SWL DX over the years with the above-mentioned antennas, and some other really odd things, too, like the metal screen on a large window or patio door, the body of a half-ton pickup, a chain-link fence, a flagpole – all of these were difficult to impossible to load up and feed power to, but they all worked as receive antennas.

And again, notice the stealthiness of all of

these ordinary items in plain sight. If you are looking for an SWL antenna solution, I encourage you to try any or all of these ideas, freed from the necessity to get it to load up and take power. Just use some common sense, friends... don't try power lines, or your neighbor's metal rose trellis, or, ahem, your neighbor's guttering...

I hope these few notions get you thinking about alternate antenna notions for the SWL. Remember, without the need to transmit, many "random" antenna ideas that would not work as transmitting antennas work just fine for receive-only – and that's all the SWL needs.

Stay safe, my friends, and keep trying those oddball antenna notions. I'll see you here again in the November issue, as we continue to explore the HF antenna jungle. Until then, happy operating!

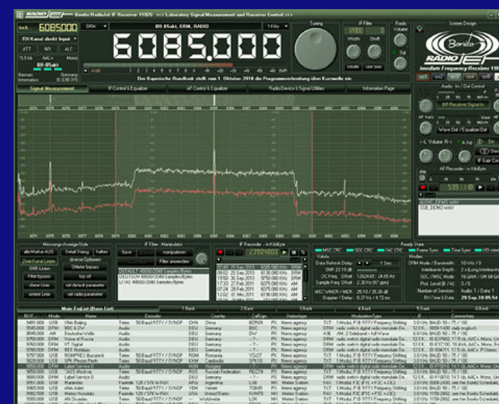

Photo by the author

*To the neighbors, it's just a gutter. To you, it's the ultimate stealth antenna.*

**Bonito RadioJet 1102S**

- High Performance IF-Receiver
- 0.04 MHz - 30 MHz
- 0.03  $\mu$ Volt sensitivity on a -137dBm noise floor
- Very high IP3: +29dBm (High-IP)
- 2 x 16 Bit ADC Multi-Channel and 1 x 24 Bit cascaded
- 24 kHz Bandwidth
- LSB, USB, CW, AM, FM, Stereo DRM
- Modern flexible User Interface
- Audio and IF recording and playback
- Integrated Frequency Database
- IF/AF Spectrum Analyzer and Oscilloscopes
- Open Source DLL for 3rd-Party Software
- Free Online-Updates



**Order RCV71**  
**Only \$699<sup>95\*</sup>**

\*plus \$22.95 UPS Ground shipping in the U.S.

[WWW.GROVE-ENT.COM](http://WWW.GROVE-ENT.COM)



**800-438-8155**

**828-837-9200 fax: 828-837-2216**

[order@grove-ent.com](mailto:order@grove-ent.com)

7540 Highway 64 West Brasstown, NC 28902



# Spying on Exoplanets

I occasionally get email from folks who check into our Roswell Astronomy Club web site. We received an interesting request for a good viewing location to test a scope being developed for use in detecting exoplanets. Professor Sara Seager, at MIT, was planning a trip with several students that would bring them through Roswell in late April.

Professor Seager wrote, "I'm a professor at MIT and my team is building a small space telescope (10 cm x 10 cm x 34 cm) called 'ExoplanetSat' to search for small exoplanets that transit sun-like stars. ExoplanetSat is a prototype intended to be launched in 2013 or 2014 as the first of a fleet of nanosatellites with the same unified science goal."

They indeed stopped by Roswell late April and we met with them at our star party on a Saturday evening. They quickly set up their equipment and began calibrating and testing their scope. Sara noted it's hard to find clear skies in the Boston area.

Sara also noted, "Attached is a photo of our set-up (with one of my students in the photo). Inside the box is the camera (lens + CMOS detector + imager electronics board). In fact, the camera is intended to go into a 3U CubeSat (10 cm x 10 cm x 34 cm) and is not too much larger than the box. (The lens diameter is about 7.7 cm)." See pix below.



Photo courtesy Sara Seager

I asked Professor Seager about the communications planned to work with the scope. She offered this information: "A communications project of interest is a current MIT project to convert our WWII-era 6m weather radar radio dish into a satellite communication ground station (SCR-584 if that means anything to you). This antenna is located atop the building I work in at MIT (~22 story building at ~300ft AGL) and is based upon a signal corps radar set from the 1940s.

"The current control system consists of

amplidyne drive electronics and selsyn position feedback tied together with a 1980s era control computer. We hope to use the existing pedestal that supports the radio dish but outfit it with new motors and modern control electronics so that the dish can track satellites.

"We intend to convert to using the NASA S-band (2.025 to 2.12 GHz uplink and 2.2 to 2.3 GHz downlink). The MIT amateur radio society has recently used the dish for moon bounce; but currently the dish transmits but cannot receive (at about 2.2 GHz). The MIT amateur radio society is part of the team. The goal is to communicate with our own CubeSats and other nanosatellites under development; such projects usually use VHF/UHF, but our high science data needs mean we want more bandwidth."

Here are a couple of pictures I took of their mockup camera and their test setup at Roswell.



The mockup camera



Above, the MIT crew is setting up the exoplanet camera before dark, north of Roswell, NM on the concrete pad on top of an old Atlas missile site. They're using a Linux-platform laptop with custom software for the image acquisition.

They also had a Canadian film crew on site that was working on a documentary on exoplanets.

Maybe you'll see a mention of us someday. Best wishes to the MIT team on the success of their project.

## ❖ GNU Radio for Radio Astronomy

GNU Radio, a free Linux software package, has been around a while but I recently started digging into its possibilities for amateur radio astronomy. The software allows you to "build" a variety of applications by piecing together software modules to create some interesting applications. Radio hardware that can be used with GNURadio can be found at:

Universal Software Radio Peripheral (USRP)  
<http://bwrc.eecs.berkeley.edu/Research/Cognitive/usrp-family-09-open.pdf>

First, I installed Ubuntu 10, a Linux based free OS (Operating System), on a spare PC. Then, I downloaded the free applications necessary to run GNU Radio. You can find a Windows version, but it appears to have to be installed in a not so simple way. (Note: There is an Ubuntu 11 version out there but I could not get 'GNU Radio' to work on it, at least not on my PC. So I went back to a clean Ubuntu 10 install and reloaded GNU Radio.)

The fussy part of getting the system going if you're not a LINUX programmer is launching it. To start up GNU Radio, launch the TERMINAL application, and enter "grc" to launch GNU Radio.

GNU Radio lets you create a chart of various function blocks that let you design pretty much whatever you desire. One expert designer, Marcus Leech, was able to create a SID (Sudden Ionospheric Disturbance) receiver fairly quickly in one afternoon. A quick web search on "GNU radio astronomy" will bring up numerous links for radio astronomy applications.

To help you get started quickly, download and go through some tutorials available at: [www.csun.edu/~skatz/katzpage/sdr\\_project/sdr/grc\\_tutorial1.pdf](http://www.csun.edu/~skatz/katzpage/sdr_project/sdr/grc_tutorial1.pdf)

There appear to be four tutorials available, and if you use the link above and modify the number after "tutorial" to 2-4, you should be able to download the PDF files. The tutorials walk you through the process step by step to build an AM radio, a SSB radio, etc. Here are a couple of references to help you get an overview of what can be done.

<http://gnuradio.org/redmine/projects/gnuradio/wiki/Hardware>  
<http://www.aavso.org/simple-easy-build-sid-receiver>



## ❖ Solar Monitoring in Alaska

Since the Sun is a massive source of energy, it's interesting to note that nobody was quite sure the Sun contributed to radio noise until WW2. Scientists considered it a possibility even back into the late 1800s. And, many tried to detect solar noise with simple antennas and coherers (iron particles in a tube, used for a detector.)

The first solid confirmation the sun was the source was made on February 27-28, 1942 by noting huge noise levels at sun-up and sun-down with WW2 radar that operated in the VHF (55-85 MHz) band. Alarmed and suspecting jamming, they soon realized the sun was the source. It was a major outburst of solar noise which was confirmed with correlation with the occurrence of huge sunspots. The hunt was on. Of course, radar jamming by the Germans was still their primary concern.

Recently, I saw an image posted by Whitham Reeve from his solar monitoring activities in Anchorage Alaska. I contacted him about his setup and he shared the following details:



Photo by Whitham Reeve

Whit noted: "The antenna is a KMA-1832 log periodic dipole array, which I purchased from KMA Antennas in late 2008. However, it took me until June 2010 to install it. KMA shut

down I believe in 2011."

His station is well engineered and he shared the sketch of his system at the bottom of the page.

Whitham captured the following solar noise bursts on two HF frequencies on March 17, 2012.

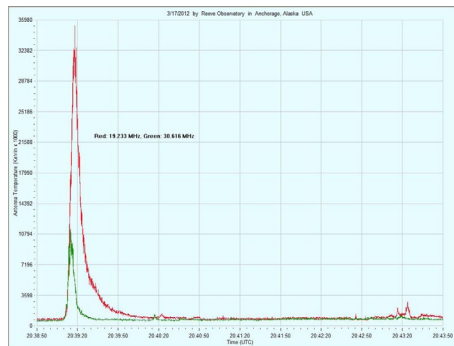

The red or highest trace on the left shows the 19.233 MHz noise level from one receiver. The weaker or green trace noise is from the second receiver, tuned to 30.616 MHz. The times on the chart's horizontal scale are in UT (Universal Time) which allows easy comparison of data from other locations. The vertical trace on his chart peaks out around 34,000,000 kelvin. Note the difference in the noise levels.

A little later, at the right hand side, you can see a weak peak detected on 30.616 MHz. These two traces represent two slices of bandwidth. Note that the sun's outburst can spread over a wider bandwidth that can be captured using a wideband receiver such as the RF Space SDR-14 using a spectrum display program such as Spectraview, a program supplied with the RF Space receivers.

Thanks to Whitham for sharing his details. He regularly contributes images to the Radio Jove observer's list-server. If you wish to join this group, go to: <http://radiojove.gsfc.nasa.gov/office/appform.htm>

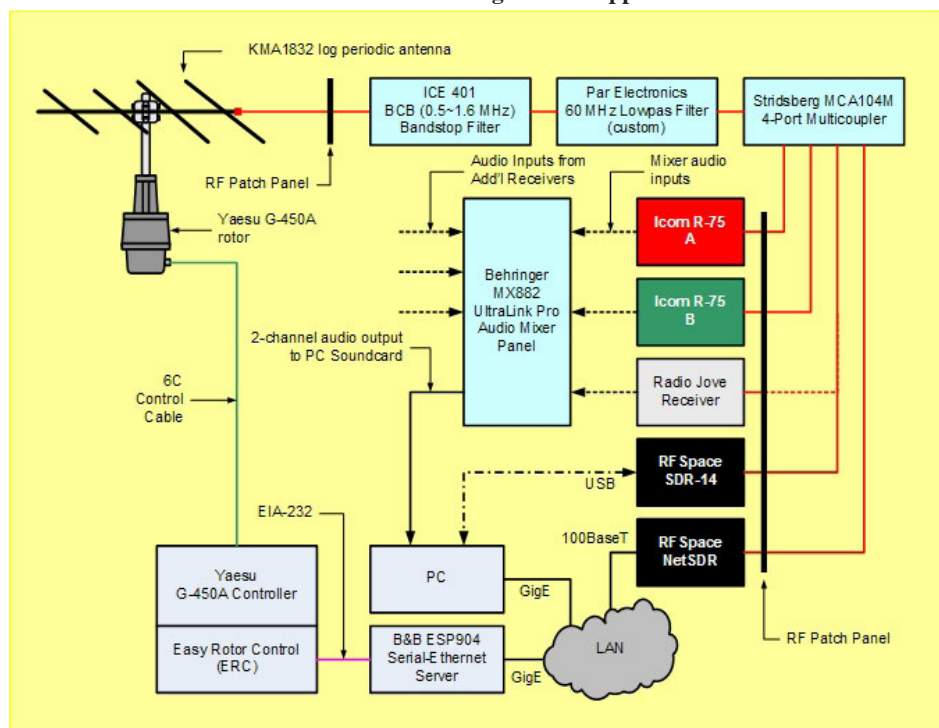

## ❖ Radio Astronomy Workshop

The first-time Radio Astronomy in Education conference is being sponsored by Radio Astronomy Supplies and the Tulsa Community College, 3727 E Apache Street, Tulsa, Oklahoma this coming October 12-14, 2012. The featured guest speaker is Kevin Shoemaker (Shoemaker Labs). For more details, contact Associate Professor of Electronics, Tommy Henderson, TCC. His e-mail is [thenders@tulsacc.edu](mailto:thenders@tulsacc.edu). You may also contact Jeffery Lichtman at [jeff@radioastronomysupplies.com](mailto:jeff@radioastronomysupplies.com).

## ❖ Radio Astronomy in the Movies

Hank Newton, a retired electronics engineer and *Monitoring Times* reader, sent me this picture he captured during an unusual configuration of the NRAO's VLA array west of Socorro, New Mexico. He added the caption, "Where did Dr. Arroyaw say Vega was located?" In case you missed the movie, Dr. Arroyaw was the astronomer in the movie Contact. I keep a copy of the picture on my bookshelf. Thanks, Hank!

Keep listening up.

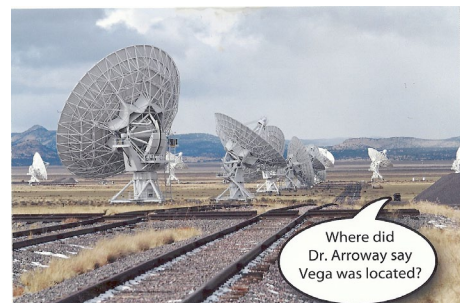

Photo by Hank Newton

**Is your local bookstore closing?**  
**Get *Monitoring Times* direct and save money!**  
**Subscribe TODAY and save \$4.20 PER ISSUE!**  
 A Subscription to MT is only **\$32.95 per year!**  
 A Subscription to MTXpress is only **\$19.95 per year!**  
**ORDER TODAY!**  
[www.monitoringtimes.com](http://www.monitoringtimes.com)  
[www.grove-ent.com](http://www.grove-ent.com)  
**800-438-8155**  
**828-837-2216 (fax)**  
[order@grove-ent.com](mailto:order@grove-ent.com)

## Setting Up a Ku-Band FTA Radio System

Story and Photos by Mario Filippi, N2HUN

Of all the times I've experienced in my six decades of life on this earth, this is sure one of the toughest for a lot of us. Paychecks are stagnating or trending downward. Bills keep coming in, and the money goes out. These conditions challenge one to stretch a dollar from every angle. At my QTH, gone are the days of pay TV subscriptions in favor of Over the Air Television (OTA). Yep, my home now sports two old-school TV antennas on the chimney, just like in the olden days.

Then I discovered Free to Air Satellite TV and added that entertainment package to my shack, which requires no subscription fees but provides worldwide listening enjoyment.

The purpose of this month's article will be to introduce the FTA TV enthusiast and interested shortwave listeners to another avenue of entertainment: Free To Air Satellite Radio.

### ❖ Entertainment Media a Constant Change

Technology is rapidly changing the world of entertainment. Just think of the numerous shortwave stations that formerly inhabited the air waves. Some are gone forever from that medium in favor of Internet sites. Others are now on FM radio.

Well, the news is good if you have an FTA dish already set up, as you have access to over 150 radio stations broadcasting music, talk, and news. Some of them may even be familiar if you already listen to shortwave.

For FTA satellite reception I use a WS International ([www.wsidigital.com](http://www.wsidigital.com)) 100 cm dish. See Photo 1. Later on in this article you'll find



Photo 1. Author's Ku band dish aimed at Galaxy 19 (97W), the mother lode of FTA radio fare.

information I have recently gathered on the different Ku band satellites and what's to be heard on them.

### ❖ Outfitting the Kitchen for FTA Radio

First off, I'll assume that you already have an FTA dish installed. Now if your LNB has two ports and one is unused, simply run another length of RG/6 coax from the LNB port to an area of the house where you want to set up a receiver for FTA radio reception. See Photo 2.



Photo 2. Two-port LNB; one coax goes to my TV, the other goes to the FTA "radio."

If you have many coax cables coming into the house, you might want to make an aesthetically pleasing entry into the house. See Photo 3.



Photo 3. Plastic enclosure, purchased from a big-box store, makes a neat entryway for cables.

In my case, I ran a 110 foot length of RG/6 from the dish, into the house, up through the attic, and back down to the kitchen. This would allow me to listen to FTA satellite radio while preparing and partaking of daily meals. Running

the cable to the kitchen took several hours of work but was well worth it. See Photo 4. When completed, the next step was to assemble the components for the FTA satellite radio.



Photo 4. Wall plate with F connector for attachment to FTA radio. Tidy installation keeps me in the XYL's good graces.

### ❖ Assembling the Small Footprint Station

Assembling the FTA radio station required a receiver, some type of LCD display, and speakers. The Dynosat 5000 receiver, sold by that great outfit Harmony FTA ([www.harmonyfta.com](http://www.harmonyfta.com)) is one of the smallest FTA set top boxes on the market, and its diminutive size lends itself to a minimal-impact installation. A rudimentary no-frills receiver, it measures a mere 10 x 6 x 1.75 inches, and its small size is matched by its price. See Photo 5.



Photo 5. Dynosat 5000 receiver, small in size but a good performer.

The Dynosat is designed for both FTA TV and radio reception, just like any other satellite receiver, but in my case it was devoted only to radio reception.

The next item required was some type of visual display, so a seven inch portable TV, purchased several years ago from Radio Shack was connected to the receiver via the supplied A/V cable. Since the TV had a very small speaker, and I have very old ears (hi hi) some type of amplified speaker system would be needed. Fortunately, I had a second-hand Logitech ([www.logitech.com](http://www.logitech.com)) amplified audio system that was pressed into service to round out the installation. See Photo 6.

Now that the station was assembled, the next mission was to start blind scanning the





Photo 6. FTA radio system assembled from old and new components, in kitchen.

different satellites to see what FTA radio programming was available.

## ❖ Searching for Radio Channels

Ku band FTA satellites available in my area range from Telstar 11 at 15 West to AMC 21 at 125 West. After three years of experience in this hobby, I had an inkling of which satellites provided radio channels, but nonetheless, for this article I scanned several of them over a period of a month to see what was up. A total of 14 birds were scanned, and those with *no* radio channels were AMC5 (79W), AMC9 (83W), AMC3 (87W), Galaxy17 (91W), Galaxy25 (93W), Galaxy16 (99W), and AMC21 (125W).

Those with radio channels are in **Table 1**. Table 1 pretty much sums up the two major players, namely Galaxy 19 and Hispasat for providing the greatest number of Free To Air channels, so I'll concentrate on those for the remainder of the article.

**Table 1. Ku-Band Satellite Radio Lineup**

| Satellite  | Longitude | # of Radio Channels |
|------------|-----------|---------------------|
| Telstar 11 | 15 W      | 7                   |
| Hispasat   | 30 W      | 50                  |
| Galaxy 3C  | 95 W      | 7                   |
| Galaxy 19  | 97 W      | 85                  |
| SES 1      | 101 W     | 7                   |
| AMC 1      | 103 W     | 2                   |
| AMC 15     | 105 W     | 3                   |

Please note that Table 1 represents my personal scanning experience and results can differ depending on many factors such as: geographical location, dish size, precipitation, obstructions, LNB sensitivity, quality/length of coax used, receiver quality, changes in the specific satellite's programming line up, and one's ability to properly aim a dish.

## ❖ Hispasat Lineup

Hispasat, at 30W, offers an interesting mix of entertainment from areas of the globe such as Europe, South America, Africa, the Middle East, and Cuba. From Europe you'll hear several stations from Radio France International, and a few from Spain. From South America are ZOE and Radio Cero. Sudan Radio is the one and only station received from Africa. The Middle East is well represented by Oman Radio, Qatar Radio, Emarat FM, and others from Iraq, Kuwait, Syria, and Saudi Arabia.

If hearing Cuba is your goal, then Hispasat is one bird to aim for as there are several Cuban stations such as Radio Habana Cuba, Radio Enciclopedia, Radio Rebelde, Radio Progreso,

Radio Taino, and Habana Radio. One station familiar to AM DXers is Radio Reloj, which identifies on the minute with "RR" in CW. It can be heard loud and clear on Hispasat.

News, talk radio, ethnic, classical, rock, and religious content can be found in the aforementioned array of stations on Hispasat. Most are in the native language, with little English to be found.

## ❖ Galaxy 19 Line-up

If one satellite can be said to have it all, it's Galaxy 19 at 97W with 85+ radio stations to choose from. Galaxy 19 reception is the closest thing to shortwave radio that FTA satellite has to offer. If all one did was to erect a stationary dish – even a 30 incher (depending on your location) – and aimed it at 97W, you'd be provided with enough diverse entertainment to keep your ears busy 24/7!

Programming in English can be found on World Radio News, RBN radio, Apostolic Bible Network, Life Talk Radio, The Overcomer, Radio Eden, Star 1 – 5, LRN.FM, KNLB.FM, Access America, and others. My favorite – and one any FTA'er, SWL, and ham should check out – is Access America, with their great line-up of hobby related shows.

Want to travel by airwave to Europe? Well, you can tune in to Radio Romania International, Voice of Croatia, Radio France International, Radio Beograd, Radio Monte Carlo, and Polskie Radio 3 and 1.

The continent of Africa can be heard by tuning into Radio Senegal International, Radio Congo, Sudan Radio, Tunis Radio 1, ORTB Radio (Benin), Radio Omdurman and Ethiopia Radio.

A plethora of stations from the Middle East are on tap, such as Saudi Radio 2, Persian Radio, Kuwait Radio 1 and 2, Syria R1, Emirates FM, Qatar Radio, Persian Radio, Oman Radio, Toloo Radio, and the list goes on and on.

I have left out a lot of miscellaneous stations that show up on a scan – some are from Asia, others are country music oriented, and some even consist of odd sounding beepers. You just have to try it out and be adventurous.

## ❖ Closing Comments

Well, my goal was to introduce the reader to a new method of listening to world radio. Set-up requires a dish, LNB, coax, an FTA receiver (some cost as little as 39 dollars), display screen (or TV), and some know-how in aiming a satellite dish. By far the most challenging part is properly aiming a dish, and if you have a friend or acquaintance who is knowledgeable, by all means seek help. Additionally you can check your local TV or satellite dealer and pay for the installation. But don't count on them knowing too much about FTA satellite; it's sort of like shortwave radio – something hobbyists enjoy but pretty much unknown by the general public.

Once installed, the receiver does all the work of capturing the stations available on the satellite and stores them into memory, just like a police scanner or shortwave radio does.

Channels come and go, so frequent rescanning is required. Change is a constant thing on FTA. Signals do not suffer from QSB (fading) as with shortwave, but you'll definitely lose signals during heavy rains (known as rain fade). Sound quality is very similar to FM radio: crisp, clear, no hiss.

Satellite reception depends on a clear Southern view of the sky, but dishes are easily erected and moved around if you have some obstructions. Dishes don't necessarily have to be elevated above ground, allowing one-man installations with minimal elbow grease. Every dish I have installed was at ground level, so those who are afraid of heights will be delighted at this prospect.

You can check out the many on-line dealers of FTA satellite equipment to become familiarized with what's required to embark on such an installation. A simple stationary dish package can cost as little as \$175. But count on buying a decent satellite finder/meter to make the installation easier. And, check out the excellent forums provided by some of the FTA satellite dealers to get hints and tips on successful installations.

Well, at this moment my kitchen is filled with beautiful folk music from Radio Beograd, a perfect companion to my repast of *Schinkenfleckerl* (ham and noodles) and a cold one. Okay... so *Schinkenfleckerl* is actually an Austrian dish: let me blind scan Galaxy 19 and see if perhaps Radio Austria might now be found on Galaxy 19! One never can tell. *Prosit!*

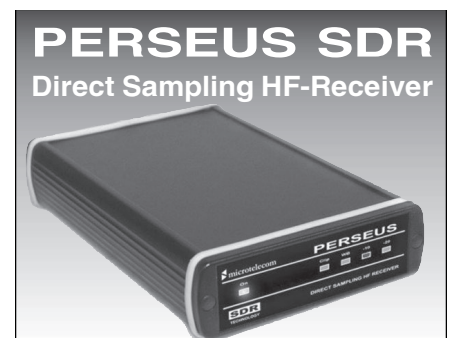

The **Microtelecom Perseus** is a cutting-edge, multimode, software defined receiver covering 10 kHz to 30 MHz. Enjoy world class performance: 3rd order IP: +31 dBm, Sensitivity: -131 dBm, Dynamic Range: 104 dB (BW 500 Hz CW). An impressive full span lab-grade spectrum display function is featured. An almost magical spectrum record feature allows you to record up to an 800 kHz portion of radio spectrum for later tuning and decoding. The audio source is via your PC soundcard. The Perseus operates from 5 VDC and comes with an international AC power supply, AC plug converter, SO239 to BNC RF adapter, USB cable and CD with software and detailed manual. Made in Italy. Visit [www.universal-radio.com](http://www.universal-radio.com) for details!

**Universal Radio**  
6830 Americana Pkwy.  
Reynoldsburg, OH 43068

◆ Orders: 800 431-3939  
◆ Info: 614 866-4267  
[www.universal-radio.com](http://www.universal-radio.com)

## Digital Dave's Delightful Degen DSP Disclosure – A Review of the Degen DE321

By Dave C. Schmarder, N2DS - Photos courtesy of the author

I have to admit it: I'm totally fascinated with these cheap Chinese radios that are available in our current electronic marketplace. After buying a more expensive Tecsun PL390, and being impressed with it, I decided I'd buy yet another one of these Chinese-made radios.

I have a need for a second set in my computer room/ham shack. I had been shuttling my 390 between here and another room daily, so it was time to buy another radio. The 390 has a lot of features that were not necessary for the computer's location. Plus, a radio small enough to put in my pocket and carry around was also desirable.

I saw the neat little Degen DE321 online, and knew this was the one for me. The major attraction besides the price was the DSP feature. DSP or Digital Signal Processing is now the magic word in radios. I wanted to see what the hubbub was all about and this one fit the bill.

### ❖ The Purchase

The price was a mere \$21 including shipping from China from an online seller. At that price, it is hard to go wrong. These radios are so inexpensive that it isn't worth it for any US retailer to bother selling them. I received my radio exactly three weeks after ordering it.

For all intents and purposes, realistically speaking, there is really no warranty on this stuff bought directly from China. With the allotted short return period and the high cost for returning something, it is assumed that you will just keep the unit and hope it works okay. Being so cheap, I'll buy a radio like this directly from China, but I did choose to buy my Tecsun PL-390 from a US short wave radio retailer for the possibility of needing warranty service. American dealers support the products they sell.

### ❖ First Impressions and Powering Up

The radio was packaged well and in a few minutes I had it up and running. This is a pretty featureless radio. It receives AM, FM and the shortwave broadcast bands. There is an on/off switch as well as volume control, tuning and band switch knobs. The telescoping antenna is for the FM and short wave bands. It's a very simple unit with no bells and whistles.

The accessories include ear buds (for stereo listening on FM), a lanyard that attaches to the corner of the DE321, and a pouch case for keeping the radio clean and sparkling. The manual is



on a mini-CD and is read using your computer's PDF reader. I popped the disc in and had a read, but the radio is so simple that the manual was of little use. Manuals for other Chinese sets are on this disc, too, and it was fun to browse a few of the other models.

Here pictured with my old 1965 General Electric P-965a radio is the DE321 for size comparison. It looks like six of these would fit inside the GE. The DE321 is about 4-3/4 inches long, 3 inches tall and nearly 7/8 inch thick. (120 × 74 × 21 mm)

The FM frequency coverage of the DE321 has two bands, making it a world radio. The first FM position 87.9 to 108 MHz is for the US and much of the rest of the world; the second FM band is the less common 64 to 87.9 MHz. I believe the reason that the two bands are included is so the same dial scale can be used wherever the radio is sold. The MW (AM) band is a single range 522 to 1710 kHz.

There are eight shortwave bands. The ranges are 5.70 to 6.40 MHz (49m), 6.80 to 7.50 MHz (41m), 9.30 to 10.0 MHz (31m), 11.60 to



12.20 MHz (25m), 13.55 to 14.15 MHz (22m), 15.10 to 15.90 MHz (19m), 17.20 to 18.0 MHz (16m), and 21.30 to 21.95 MHz (13m). Missing are the less popular "tropical bands" of 60, 75, and 90 meter bands.

The battery supply consists of two AA cells, either rechargeable or disposable types. I'm using a pair of the "hybrid" or low discharge batteries. I started using these in my camera,

rather than the old style NiCad batteries. They are worth the extra money! The DE321 does not have a USB charging jack, so the batteries must be charged externally.

### ❖ Tuning In with the Degen DE321

The DE321 works fine, but being a cheap and featureless device, you might want to tone down your expectations. First, the audio is very good! The speaker diameter is only two inches or 50mm and they get all they can out of this little transducer. The audio is loud and clear and the sound is clean. The FM sound is even better with the stereo ear buds.

The volume control is the old fashioned potentiometer type, with smooth volume transitions. This is an improvement over the stepped audio control settings in the Tecsun PL390.

### ❖ Technical Tidbits

The tuning system was a mystery to me until I did some online investigating. Is this a digital or analog radio? Turns out it is both, but mostly digital. I looked at the Silicon Labs website and found that the SI4844 chip appears to match what the Degen DE321 radio has inside.

The rotary tuning control is a simple analog potentiometer. A thumb wheel knob is connected to the pot and the slide rule style dial is moved by a dial cord. Therefore the readout accuracy won't be great, but it will tell you where in the band you are tuned.

The receiving frequency is determined by the voltage sent to the silicon labs chip via a variable resistor voltage divider. The chip then translates this voltage into a specific channel frequency step.

A slide switch on top of the radio selects the band. This switch selects a point on a precision resistor ladder to tell the chip which band you want to use. No RF switching is used.

The chip is externally programmed to establish the exact frequency ranges. The programming is done with precision resistors connected to certain pins. So, if you move to a different part of the world, you will only need to change the resistors. The MW band is set to select 9- or 10-kHz steps. All this is outlined in Silicon Labs PDF files available at the documents tab on their website. Look for the application notes – AN602. pdf.

There is a small LED that indicates when you are tuned correctly. The tuning appears to



have a "frequency locking" effect, but it is just the receiver stepping from one frequency to another. You are either tuned or not tuned to a station. One can't just tune on to a station as with an analog tuned radio.

The DE321 is not a superheterodyne receiver, which has been the radio design norm for the past 70 years. There is no usual intermediate frequency, mixers, or variable analog oscillators. The analog signal comes in and is converted to a digital format. After the processing, the digital signal is converted to analog audio to be amplified. According to the chip spec sheet, there are no coil alignments, and no tracking adjustments. It all just works!

## ❖ Daytime Reception

I am in a mostly fringe signal level reception area. There are a couple of strong FM stations, but they are not too close. The same is true on the MW (AM) band. The strongest stations are an 800 watt station about 10 miles away and a couple of 5-kw daytimers about 12 miles from me.

The FM section picks up the stronger stations very well. I found the low end of the band has surprisingly good reception. The short telescoping antenna, which usually portends mediocre low end of the band reception, nevertheless received fairly distant NPR stations at the bottom of the dial quite well.

The MW/AM band hears the moderate to strong signal strength stations well. The weaker stations aren't usable. The ferrite antenna coil is not very large and this impacts the receiver sensitivity.

I then switched to shortwave. The first station I heard was Radio Havana. They generally have a good signal here, so it wasn't a surprise. I was able to hear other stations on several of the bands.

## ❖ Nighttime Reception

One thing I noticed at night was that as a MW station faded, the radio would quickly cut out and then come back on. By carefully adjusting the tuning control, I was able to minimize this effect.

This DE321 will not dig down into the noise for the weak DX (distant stations). It is one of those sets that only gets the low hanging fruit, so plan on listening only to the big signal stations. I did occasionally hear some of the weaker stations, but not regularly.

## ❖ Some Hot Rodding Tips

I'm not the type of guy who leaves things alone. I'm always thinking about my friends

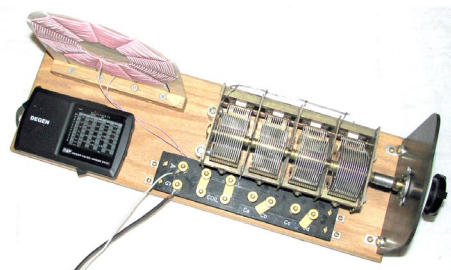

### RELATED WEBSITE LINKS

Silicon Labs Si4844 IC: [www.silabs.com/products/audiovideo/amfmreceivers/Pages/Si4840-44.aspx](http://www.silabs.com/products/audiovideo/amfmreceivers/Pages/Si4840-44.aspx)

Ultralight DX Yahoo! Group: <http://groups.yahoo.com/group/ultralightdx>

1923 Paragon Radio Compared with More Modern Counterparts <http://makearadio.com/restoration/paragon-radio-restoration.php>

Antenna coupler project as mentioned in the article and shown in the picture <http://makearadio.com/misc-stuff/antennatuner.php>

over at the Yahoo! UltralightDX Group and how they might make this radio really sing. Here are a couple of thoughts, but first realize these ideas have not been tested and can possibly result in the destruction of your radio. First, disconnect the 100k ohm tuning pot, and replace it with an external ten turn 100k ohm pot. The radio will be easier to tune. Second, get a big ferrite bar and wind it with Litz wire and then connect it in place of the small internal ferrite bar. That should improve the sensitivity!

If you have an external wire antenna and a ground, the DE321 can be placed near a coil connected to the outside antenna and ground for very good reception, day or night. I use my old 1923 Paragon radio that is connected to the outside antenna. I tried my crystal radio antenna coupler too, and that helped the reception, allowing many stations to overcome my in-room computer noise.



## ❖ Conclusion

The purchase of the Degen DE321 was pleasant and hassle free. Although it doesn't receive as well as expensive radios, I never expected it to. This leaves open the possibility of DX reception under less than optimum conditions.

Would I buy again? Yes I would.

I will buy more of those little Chinese DSP radios. DSP is the way to go.

*Dave is a retired industrial electronics parts seller. He now maintains his hobby crystal radio website <http://makearadio.com>. He may be reached at [dlmr@makearadio.com](mailto:dlmr@makearadio.com)*

Wouldn't it be nice if every page of *Monitoring Times* was in FULL COLOR? It IS with MTXpress! MTXpress, our digital version of your favorite magazine, is the complete magazine from cover-to-cover in **FULL COLOR!** It may not seem like much when you first think about it, but once you've had a taste of those gorgeous graphics, you'll never want black and white again! And you can try it for FREE by going to [monitoringtimes.com](http://monitoringtimes.com) and clicking on the FREE SAMPLE on the left-hand side. *Try it today!*

## FAST DELIVERY

Every issue is delivered right to your computer every month. No need to wait for the Post Office any longer!

## PRINTABLE

If you want a hard copy of any or all of the issue, you can print it in high-resolution right to your own printer. It's even in full-color! (if you have a color-capable printer)

## AFFORDABLE

**Only \$19.95 per year or only \$11 in addition to your print subscription!**

# What's NEW

## Tell them you saw it in Monitoring Times

Larry Van Horn, New Products Editor

### ARRL's Low Power Communication

"Just a Little RF Power Goes a Long Way!" That is the mantra of former *MT* columnist Rich Arland, K7SZ, who has just released a 4<sup>th</sup> edition of his new book on QRP communications and amateur radio.

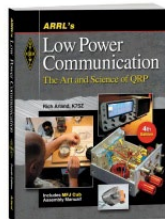

#### ARRL's Low Power

*Communication* is your guidebook to the fascinating world of low power QRP operating. With only five watts or less – sometimes much less – you can enjoy conversations over hundreds and even thousands of miles.

Some of the topics in this new book include:

- Tips to Get You Started the Right Way – An introduction to QRP operating, FAQs for newbies and tips that even experienced amateurs will appreciate.
- Equipment and Station Accessories – Off-the-shelf commercial gear, kit building and homebrew, including an all-new homebrew photo gallery.
- Antennas for QRP (Updated and Expanded) – Wire beams, loops, dipoles, portable antennas and a look at the author's new stealth antenna design.
- Operating Strategies – Contesting, awards and advanced techniques for becoming a successful QRP operator.
- Emergency Communications – Training, planning and other factors for utilizing low-power gear during an emergency.
- HF Propagation for the QRP'er – An authoritative look at likely propagation conditions for Solar Cycle 24.
- Plus, QRP calling frequencies, manufacturers... and much more!

This new book also includes the complete assembly manual for the MFJ Cub Transceiver Kit (sold separately). Build this tiny, high-performance radio in just a few hours and get countless hours of enjoyment working the world with QRP.

The *ARRL's Low Power Communication*, 4th Edition sells for \$27.95.

### Short Antennas for 160 Meter Radio

160 meters is known to radio amateurs as "top band." However, 160-meter antennas can be large and difficult to install due to lack of available space.

*Short Antennas for 160 Meter Radio* dares to discuss the possibility of smaller antennas for this intriguing band. Intended for amateurs with advanced skills in antenna modeling, Grant Bingeman, KM5KG, walks you through the theory behind innovative

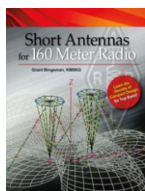

designs for relatively compact antennas. You'll learn how to enhance bandwidth, minimize loss, and employ other techniques to enjoy 160 meters with limited real estate.

Contents of this new ARRL book includes:

- Short Antenna Behavior
- A Better Way to Define Antenna Bandwidth
- Why Top-loading Can Improve Short Antenna Performance
- Top Hat Arrangements
- Inverted Cone Antennas
- Closed Antennas
- Antennas with Two Driven Elements
- T-shaped Antennas
- Inverted L-shaped Antennas
- Antennas with Four Driven Elements
- Spiral Antennas
- Small Horizontal Antennas
- Quadrature Feed Arrangements

This new 64 page soft cover book sells for \$22.95.

### ARRL Extra Class License Manual

If you want all the privileges available to a licensed U.S. amateur radio operator, you will need to pass your Extra Class written exam. Ask any ham who has taken this test and they will probably tell you it is definitely no cake walk. You have to have some good reference material in order to pass that 50-question Extra Class test.

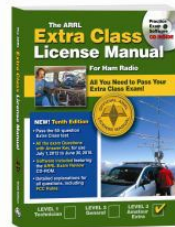

Of the best resources in this regard, the new 10th Edition *ARRL Extra Class License Manual* should be part of your study regime. All the Exam Questions with Answer Key (for use from July 1, 2012 to June 30, 2016) are included with practice exam software on CD-ROM. With this guide you will get detailed explanations for all questions, including FCC rules.

The *ARRL Extra Class License Manual* is your ticket to every privilege granted to amateur radio operators. Expert instruction will lead you through all of the knowledge you need to pass the exam: rules, specific operating skills and more advanced electronics theory. As an Extra Class licensee, you will have full privileges on all frequencies authorized by the FCC for amateur radio. To upgrade to Extra Class, you must already hold a General Class license (or have recently passed all of the exams required for a General Class license). Upgrading to an Extra license only requires passing a written examination.

Use this book to study for your Extra Class (Element 4) license exam. Every page presents information you will need to pass the exam and become an effective operator. For study purposes, information is presented in small sections on operating practices, rules and regulations, Electrical

principles, components and building blocks, electronic circuits, radio signals and measurements, radio modes and equipment, antennas and feed lines, topics in radio propagation, and safety.

As mentioned above, this book includes the ARRL Exam Review CD-ROM (requires Microsoft Windows). Use it with this book to review the study material and take randomly generated practice exams using questions from the actual examination question pool. You won't have any surprises on exam day!

CD-ROM System Requirements: Microsoft Windows 2000/XP/Vista/Windows 7, a color display, 20 MB free hard drive space. (Please note: the practice exam software is not MAC compatible.)

This ARRL soft cover 496 page book sells for \$29.95.

### ARRL's Extra Q & A, 3rd Edition

If you are pretty sharp on electronic theory, amateur radio operations, and FCC regulations, then maybe you want to just study all the questions that are part of the amateur radio Extra class question pool.

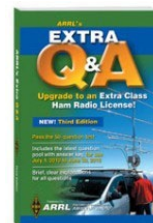

This new third edition of *ARRL's Extra Q & A* is your authoritative guide to every question in the Extra (Element 4) question pool – everything you need to pass the top-level amateur radio license exam! With more than 700 questions included in the question pool, using *ARRL's Extra Q & A* is the best way to review for your 50-question Extra Class written exam with confidence.

This new book includes the latest question pool with answer key, for use July 1, 2012 to June 30, 2016.

There are even brief explanations that follow each question in the book. This 320 page soft cover book sells for \$17.95.

All of these fine ARRL publications mentioned above are all available from the ARRL website ([www.arrl.org](http://www.arrl.org)), via their toll free order line at 1-888-277-5289 9 (8 a.m. to 5 p.m. Monday through Friday, except holidays), or via snail mail to ARRL, 225 Main Street, Newington, CT 06111-1494. You should also check your local amateur radio dealer or selected *Monitoring Times* advertisers for these and other ARRL publications.

### DX Engineering DXE-UT-KIT-DBR Deburbing Kit

The DX Engineering DXE-UT-KIT-DBR, designed and manufactured in the United States, is ideal for reaming and deburring rough-cut tubing edges with minimum effort. This new utility



tool kit is usable on all tubing and pipe sizes from 3/8-inch to 3.5-inches OD, including aluminum, copper, steel, fiberglass, and PVC. The kit includes 2 1/4-inch DXE-UT-2125 and 3 1/2-inch DXE-UT-3500 cylindrical deburring tools (also available separately) DXE-22600 adjustable deburring tool and a half-round file, all in custom made case with pre-cut high density foam.



Both cylindrical tools are reversible, ideal for deburring both ID and OD of aluminum antenna tubing prior to telescoping sections together. These tools assure a smooth fit without galling and seizing that can occur with the slightest roughness. Only a couple of revolutions with very light pressure are needed to produce excellent results.

The adjustable deburring tool features a variable length blade holder that extends from 1/2 inch to 5 inches. This allows access to burrs deep inside tubing or other hard to reach places. Blades can be inserted at 90 degrees for deburring cross holes. It includes one blade for aluminum and steel and one blade for cast iron and brass.

Made from heat-treated carbon steel, the half-round file is especially useful for helping deburr the inside of cut tubing ends. It features a durable rubber handle with plastic inserts for comfort and convenience. The DX Engineering introductory price is \$89.95 and for more information or to order, visit [www.dxengineering.com](http://www.dxengineering.com).

## DX Engineering 160 Meter Vertical Antenna

Now you can have a high-performance vertical antenna specifically for the 160 meter band and achieve the strongest possible presence at your power level and be competitive!

The DX Engineering DXE-160VA-1 is a slow taper 55-foot high mono band vertical antenna system. The custom designed capacity hat system allows coverage on 160 meters with unparalleled success in a compact antenna.

The DXE-160VA-1 160 meter band vertical antenna is tunable with an impressive 40 kHz bandwidth. This means that operation on the CW DX frequencies and DX Phone frequencies is within range of most radio internal tuners – no antenna changes are necessary. Power handling capability is 5kW on sideband or CW.

Included with this antenna system is a rugged stainless steel pivot fixture for ease of assembly and adjustments. Engineered with 6061-T8 and 6063-T832 corrosion-resistant aluminum tubing, stainless steel mounting brackets and stainless



steel hardware, making this antenna very durable and attractive. Steady-state wind survival is in excess of 50 mph without guys.

Why does this antenna perform so well for its height? The capacity hat is large enough that the current along the radiator is almost constant. Typical shortened vertical antennas for this band, with smaller top-hats have currents that vary along the length and end up producing much less signal strength.

Introductory price for this new antenna is \$839.95. An optional DXE-VRW-1 manual winch for easy one-person raising and lowering of this antenna is available for \$169.95. For more information or to order, visit [www.dxengineering.com](http://www.dxengineering.com).

## Wavecom Releases New Updates

Wavecom has released new updates for their W-PCIE, W-PCI, W-CODE V8.1.00, W-BV (BitView) V2.5.00, and W-Sat-email-Decoder V2.1.00 products.

- These main updates include the following:
- New modes: NXDN with demodulated bitstream (symbol) output
  - STANAG-4285 has a demodulated symbol output for further analyze in W-BitView Tool
  - STANAG-4285 center frequency search extended to +/- 160 Hz and various significant improvement in decoding quality
  - Phase Plane HF for STANAG-4285 (with DPSK demodulator) improved significantly
  - W-BV: add on an entry to import demodulated symbols HF STANAG-4285 from W-PCI/e and W-CODE
  - W-BV: add on "Generate Pseudo-Noise" function and various custom functions to analyze STANAG-4285 demodulated bit stream output
  - Metadata output extended in W-Sat-email-Decoder V2.1.00
  - New EasySAT System for W-PCIE and W-PCI decoders V1.0.00
  - Various improvements and bug-fixes

A DVD with these new releases can be requested. See the following website for more information ([www.wavecom.ch/softwaredownload.htm](http://www.wavecom.ch/softwaredownload.htm)) or contact the company at Wavecom Elektronik AG, Hammerstrasse 8, 8180 Buelach, Switzerland, Tel: +41-44-8727060/ Fax: +41-44-8727066.

## New Features for inReach Communicator

DeLorme, a company that specializes in personal satellite messaging, tracking and navigation technology, recently announced the release of a major upgrade for inReach™ two-way satellite communicators.

inReach users can download the latest firmware version to their inReach devices at no cost. Major product improvements and enhancements in the new release include extended battery life and recharging options. In addition, the newly-updated Earthmate app enables world topographic map downloads.

Introduced to the market in November 2011, inReach is the first affordable satellite communicator offering two-way personal text messaging with delivery confirmation, SOS alerting and

Follow-Me/Find-Me tracking and location.

inReach operates over the Iridium satellite network for truly global coverage, high network reliability and fast data connections with end-to-end message delivery in less than 60 seconds anywhere on Earth. Two \$250 devices are available: one inReach pairs with most popular smart phones and tablets for two-way global messaging in the 90 percent of the world's surface not served by cellular phone networks; the other pairs with the DeLorme PN-60w GPS unit. Both require a \$19.95 activation fee and subscription plan, which starts at \$9.95 per month for the safety plan, to \$25 per month for recreational year round use, or you can also pay a higher rate and purchase four months at a time. More expensive plans are also available for heavy users, but all SOS calls are free.

The ruggedized handheld inReach device has an IP68 waterproof and dustproof rating, is impact resistant and works under extreme high and low temperatures.

inReach users can choose AA-size lithium, alkaline or rechargeable nickel metal hydride (NiMH) batteries to power the device. With the new upgrade, battery life has been doubled from 60 to 125 hours for standard lithium AA batteries, with ten-minute reporting intervals. When running on alkaline batteries, which are lower cost and readily available at retail stores everywhere, battery life is now extended up to 72 hours.

For maximum flexibility and minimal environmental impact, the rechargeable NiMH batteries can run up to 75 hours between charges and can be recharged up to 500 times. When connected to commercially available solar chargers, NiMH batteries provide an extremely cost-effective solution for long trips away from electrical power sources.

The Earthmate app now enables downloading of seamless topographic maps of the world from DeLorme's new Digital Atlas of the Earth (DAE). Users can download and store all the maps they need for travel all around the world. DAE detail includes elevation contours, land cover, place names, major roads as well as connectors and urban streets, railroads, transportation hubs and places of interest including museums, landmarks, dams, stadiums, ports and more. The extensive river and stream detail makes DAE one of the premier hydrography data sources in the world.

"DeLorme is committed to a program of continuous improvement for our products," said Patrick Shay, DeLorme vice president and general manager. "We listen carefully to the voices of our customers when developing upgrades that will enhance the inReach experience."

inReach users can download the new firmware free at <https://explore.delorme.com>. The latest Earthmate app is available at no charge from the companion device's online app store.

For more information on inReach, visit [www.inreachdelorme.com/](http://www.inreachdelorme.com/).

Books and equipment for announcement or review should be sent to What's New, c/o Monitoring Times, 7540 Highway 64 West, Brasstown, NC 28902. Press releases may be faxed to 828-837-2216 or emailed to Larry Van Horn, [larryvanhorn@monitoringtimes.com](mailto:larryvanhorn@monitoringtimes.com). When ordering or inquiring about the products mentioned in this column, be sure to tell them that you saw it in the pages of *Monitoring Times* magazine.



# to the editors

editor@monitoringtimes.com

*This column is open to your considered comments. Opinions expressed here are not necessarily those of Monitoring Times. Your letters may be edited or shortened for clarity and length. Please mail to Letters to the Editor, 7540 Hwy 64 West, Brasstown, NC 28902 or email editor@monitoringtimes.com*  
**Happy monitoring!**  
*Rachel Baughn, Editor*

## MT'S GOT IT ALL!

As a new subscriber, but one that has been into Radio for many years – 25 total as a licensed trans-atlantic Ham – I have to remark how refreshing it is to find a magazine that covers the old and the new, and also the hobbies of SWL and Ham radio.

I was an SWL long before I passed my G0, and a G0 long before my W3 call, but throughout I have listened to shortwave, trying to capture that rare DX, and known stations also. Indeed my station comprises of more shortwave receivers than ham. From my fully restored 1939 Hammarlund HQ-120X, which I use as my main receiver, with its matching 10" speaker, to the 1949 Zenith Transoceanic that happily graces my bench, the majority of my equipment covers the broadcast shortwave bands better than it does the IARU/FCC allocated frequencies.

During the past 5 years having lived primarily stateside, I have longed for the days when I was a young child, listening to the foreign stations from Europe, the Soviet Union, and also the Middle East. While many are still operating, some have alas disappeared. BBC World no longer broadcasts to the U.S, while Deutsche Welle has changed their focus, and now RNW and CBC join the ranks of the Titans no longer with us.

However, there are still many shortwave stations still broadcasting, and I'm not talking about the Reverend Stair. We have Voice of Vietnam, RCI, Slovakia, Slovenia, R. Vatican, R. Taiwan, R. China, RHC, Radio Cairo, VOI, and many more, still operating on shortwave, and still giving insight into their respective cultures, economies, and their sense of nationhood.

After reading your magazine, I was impressed by the shortwave schedules that you publish and the entire content of the magazine in all actuality. Many radio-focused publications, such as those from CQ, and even those from ARRL, leave the shortwave listener behind.

Seemingly gone are the days of radio as a hobby, and it's now being touted in most publications as an Emergency Communications media. Yet *MT* has several heavyweight articles this month alone; the two that really caught my eye were the ones regarding General Electric and their early experimentation, and the article about Navy Communications. From the past to the present, *MT* seemingly has it all, and I am honored to support the magazine, and its publishers.

I am truly looking forward to the next issue, and to seeing your continuing support of all things radio, from past to present, from SWL to Ham.

*MT* now has my subscription fee instead of ARRL, and will continue to do so. Thank you, *Monitoring Times*.

*Darryl, W3DBJ (former G0NNB)*

For my money, I think that the *MT's* overall content is better than *QST* these days. The new layout of *QST* seems to have an overabundance of white space, and the articles seem a little truncated

with the increasing reliance on their on-line extra content.

*MT's* content really seems to keep improving, both in breadth and depth. I don't think that an issue goes by without me putting to use something that I've read. Also, your current set of authors seems very "Elmer" oriented to me. All very good stuff!

*Roger Swearengen*

## GE'S PIONEER BC STATIONS

I have subscribed to *MT* for many years. It is the best radio periodical published. I was thrilled to see the above titled story in July's edition. I grew up in Schenectady, NY in the 1950s and '60s and my interest in radio started when I received a crystal radio kit for Christmas when I was eight. We lived about 2 miles from WGY's transmission tower, and with a 50kW station I could hear nothing else, it was so loud that the headphones were also a speaker.

I began to build and improve my own crystal radios and when I was 12 bought a Hallicrafters S-40 from a ham friend of my father.

I received my novice license the next year and have spent the past fifty years enjoying all forms of listening. Your stories and columns have often spurred me into new modes and frequencies. John Schneider's article was interesting and informative. Much of the information in it was new to me and I have shared it with several friends that still live in the Schenectady area. Thanks again and keep up the great work.

*Robert Milne W1RMM*

I just got my July issue of *MT*, and the cover photo looks great! Thanks for the nice spread for the article. There is one small error in the caption – the building was used from 1924-32, not 1934-40.

*John Schneider, author*

In complement to the article on General Electric stations in *Monitoring Times*, I offer the scanned item. It is from a 1954 General Electric Supply Company Diary. In 1954, GE laid claim to the stations in Schenectady.

When the New York Thruway opened, we used it to go to Connecticut from Erie. It was the fastest way. On a map, US6 looked most direct but it was mountainous. In those early days, we had to travel to Williamsville to attain the Thruway. The Erie portion had not yet been built. Of necessity we went past the WGY transmitter, but at that age I did not much pay attention to it.

When I made a trip from Lexington, KY to CT in 1972, my first leg took me to Erie. The next day I drove the Thruway and Mass Tpk to Springfield, MA. That time I paid attention. The WGY tower was next to the Thruway. Its half wavelength antenna was guyed at the waist like WHAS and WLW. Next to that were the antennas for WGEO.

My next trip on that portion of the Thruway was in 2003. The original WGY antenna had been

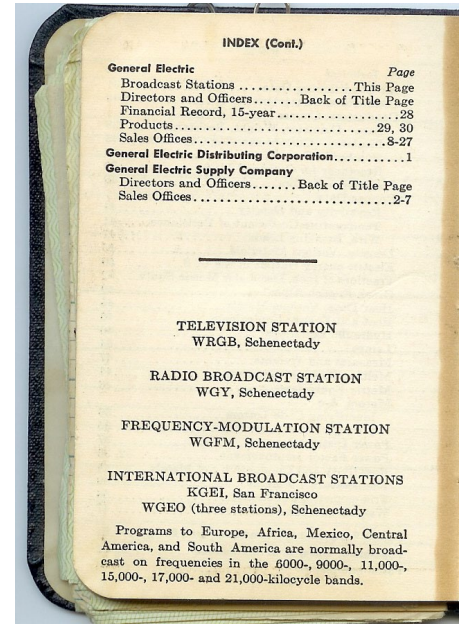

replaced with one guyed several places (as had the WHAS one after it blew down in 1983). WGEO went the way of WLW-O. WGEO was torn down.

*Tim Kuryla, Lexington, KY*

## RADIO MUSEUMS

June's cover [*close-up of two radios from the Museum of Radio and Technology in Huntington, WV-ed.*] – Now that's a fun cover!

I run a BC-375E and it keeps me warm in the winter. Nowadays, I keep the windows open!

*Jim K6FWT, CA*

Ken, I read your story on the radio museums, here is one more for your list – the Chatham Marconi Maritime Center located in North Chatham, Mass. The station was built by Marconi in the early 1900s. They have a very good set-up.

*Rich*

Thanks, Rich, for the additional listing. We'll put that in our online version when it goes up. I found it here: [www.chathammarconi.org/](http://www.chathammarconi.org/). Thanks, again, Rich!

*Ken KS4ZR*

## CHECK THIS OUT!

Radio Powered by Mini-hydro Turbine [www.reghardware.com/2011/04/13/review\\_h2o\\_water\\_powered\\_radio/](http://www.reghardware.com/2011/04/13/review_h2o_water_powered_radio/)

Sample quote: 'The concept of the H2O is gloriously simple – water flows through a patented micro-turbine and generator that, in turn, charges a Nickel-metal hydride battery and thus powers the radio. The minimalist, retro design incorporates just a few buttons for radio tuning and volume; a mono speaker dishes out the perfectly acceptable, if a little tinny, audio.'

*Henry Laviere*



# GROVE

**Your Source for Radio Scanners,  
Receivers, Accessories,  
and Publications**

**Grove means service. You won't find  
better customer service anywhere. BUY TODAY!**

Established in 1979 by well-known communications expert Bob Grove, Grove Enterprises has become a world leader in radio monitoring equipment, accessories, and publications.

If you decide you don't like a product, Grove Enterprises doesn't penalize you for it. There is NO restocking fee so long as you call our toll free number for a return authorization within fifteen days of shipment and the item is returned in new condition. Once the item is received we will give you credit toward another item or issue a full refund (less shipping charges). Software cannot be returned if opened.

That's it! No hassle! No negotiations! Just call 1-800-438-8155 and our friendly staff will assist you with a return authorization number.



### Shipping/Handling Charges (UPS Ground)

| Total Order      | Shipping Charges |
|------------------|------------------|
| \$1-\$19.99      | \$7.95           |
| \$20-\$99.99     | \$17.95          |
| \$100-\$399.99   | \$19.95          |
| \$400-\$899.99   | \$22.95          |
| \$900-\$1499.99  | \$25.95          |
| \$1500-\$1999.99 | \$26.95          |
| \$2000-\$2499.99 | \$28.95          |
| \$2500+          | \$32.95          |

# GROVE

**(800) 438-8155**

**www.grove-ent.com**

**Grove Enterprises, Inc. - www.grove-ent.com**

(800) 438-8155; (828) 837-9200; fax: (828) 837-2216

7540 Hwy 64 W; Brasstown, NC 28902 - email: order@grove-ent.com

### ALINCO

DJ-X7T  
DJ-X11T

SCN 3  
SCN24

\$179.95  
\$319.95

### GRE

PSR-100  
PSR-120  
PSR-200U  
PSR-310  
PSR-410  
PSR-500  
PSR-600  
PSR-700  
PSR-800

SCN16  
SCN25  
SCN17  
SCN22  
SCN23  
SCN18  
SCN19  
SCN56  
SCN57

\$89.95  
\$109.95  
\$89.95  
\$149.95  
\$149.95  
\$339.95  
\$349.95  
\$179.95  
\$449.95

### UNIDEN

BC125AT  
BCT15X  
BCD996XT  
BCD396XT  
BCD346XT  
BCT8  
HomePatrol-1  
BC355C  
BC95XLT

DS-BC125AT  
SCN31  
SCN21  
SCN53  
SCN45  
SCN08  
SCN55  
DS-BC355  
DS-BC95XLT

\$129.95  
\$209.95  
\$449.95  
\$439.95  
\$199.95  
\$162.95  
\$489.95  
\$99.95  
\$99.95

### ICOM

R6  
R20

SCN54  
SCN 20

\$199.95  
\$539.95

### AOR

AR8200IIIB

SCN51

\$729.95

### RAMSEY

ABM1 Air Band Monitor

SCN05

\$149.95

### ANTENNAS & CABLES

|  |          |          |
|--|----------|----------|
| AOR DA3000 Wideband Discone                | ANT11    | \$119.95 |
| Diamond D3000N Wideband Discone            | ANT70    | \$119.95 |
| AOR DA5000 UHF Discone                     | ANT72    | \$389.95 |
| Grove Hidden Flex-tenna                    | ANT49    | \$19.95  |
| Austin Conдор                              | ANT 14   | \$34.95  |
| Grove Scanner Beam III                     | ANT 03   | \$69.95  |
| Procomm CD144M/BN mag mount antenna        | ANT50    | \$19.95  |
| OMNI II Scanner                            | ANT 5    | \$29.95  |
| WiNRADiO AX-71C Discone                    | ANT01    | \$89.95  |
| WiNRADiO AX-37A Wide-band Log Periodic     | ANT28    | \$389.95 |
| WiNRADiO AX-37AM Wide-band Log Periodic    | ANT29    | \$499.95 |
| WiNRADiO AX-07B flexible VHF/UHF           | ANT47    | \$27.95  |
| WiNRADiO AX-91M magnetic antenna base      | ANT48    | \$27.95  |
| Icom AH-8000 Wide-coverage Discone         | ANT54    | \$269.95 |
| Grove Flex-tenna HVU                       | ANT45    | \$14.95  |
| Grove Flex-tenna VU                        | ANT46    | \$9.95   |
| Professional Wideband Discone              | ANT 9    | \$99.95  |
| Scantenna + 50' coax                       | ANT 7    | \$49.95  |
| Super-M Ultra Base Station                 | ANT61MBS | \$189.95 |
| Super-M Ultra Mobile antenna w/NMO mount   | ANT61NMO | \$109.95 |
| Super-M Ultra Mobile mag mount             | ANT61    | \$124.95 |
| Super-M Multiband base antenna             | ANT10MBS | \$99.95  |
| Super-M Mobile antenna w/ NMO mount        | ANT10NMO | \$79.95  |
| AOR DA3200 ultra wideband discone antenna  | ANT 62   | \$214.95 |
| AOR MA500 Wide Range                       | ANT 12   | \$119.95 |
| AOR SA7000 super-wide receiving            | ANT 39   | \$269.95 |
| WiNRADiO WR-AX-31C Log-Periodic Antenna    | ANT 58   | \$189.95 |
| WiNRADiO AX-24B discone antenna            | ANT 63   | \$319.95 |
| Grove Universal Telescoping Whip           | ANT 6    | \$14.95  |
| Diamond HT/Receiving & Scanner antenna     | ANT 64   | \$21.95  |
| Super-M Superior Mobile Antenna            | ANT 10   | \$94.95  |
| Create CLP51301N Log-Periodic Antenna      | ANT 16   | \$439.95 |
| Create CLP51302N Log-Periodic Antenna      | ANT 17   | \$319.95 |
| Diamond SRH77CA HT/Receiving & Scanner Ant | ANT67    | \$21.95  |
| 25' of RG-6U cable                         | CBL25    | \$14.95  |
| 50' of RG-6U cable                         | CBL 50   | \$19.95  |
| 100' of RG-6U cable                        | CBL 100  | \$24.95  |

### MISCELLANEOUS ACCESSORIES

|                                 |           |         |
|---------------------------------|-----------|---------|
| UNIDEN UA-72 DC CORD            | DCC 19    | \$19.95 |
| Universal Cigarette Adaptor     | DCC 3     | \$12.95 |
| Ramsey Broadband Preamp         | PRE 2     | \$59.95 |
| Scantat-Lite Plus               | SFT 19    | \$29.95 |
| PAR VHF Intermod Filter 152MHz  | FTR 152DS | \$69.95 |
| PAR VHF Intermod Filter 158MHz  | FTR 158DS | \$69.95 |
| PAR VHF Intermod Filter 462MHz  | FTR 462DS | \$69.95 |
| FM Trap Filter 88-108MHz        | FTR-FMDS  | \$69.95 |
| PAR NOAA Weather Filter 162 MHz | FTR 162DS | \$69.95 |
| GRE Superamplifier              | PRE 1     | \$53.95 |
| Noise Cancelling Mobile Speaker | SPK 7     | \$8.95  |

## INDEX OF ADVERTISERS

|                                |                    |
|--------------------------------|--------------------|
| Antique Wireless .....         | 63                 |
| AOR .....                      | 3                  |
| ARRL.....                      | CVR3               |
| Kevin Carey (Longwave).....    | 76                 |
| C Crane.....                   | 31                 |
| Computer Aided Technology..... | 21                 |
| Grove .....                    | 17, 59, 61, 65, 75 |
| ICOM .....                     | CVR4               |
| MT Express .....               | CVR2, 67, 71       |
| NASB.....                      | 7                  |
| Profiles in Radio .....        | 76                 |
| Ernest Robl .....              | 76                 |
| Roswell Astronomy Club.....    | 76                 |
| Stealth .....                  | 76                 |
| TEAK Publishing .....          | 45                 |
| Universal Radio .....          | 69, 76             |
| W5YI .....                     | 5                  |
| WiNRADiO .....                 | 1                  |

Reach new customers with your advertising message in *Monitoring Times*! Contact Judy Grove at 1-800-438-8155 or email [judy@grove-ent.com](mailto:judy@grove-ent.com)

## Stock Exchange

For information on Stock Exchange or commercial advertising, contact Judy Grove at 1-800-438-8155 or [judy@grove-ent.com](mailto:judy@grove-ent.com)

Line Ads \$1 per word

*Thank you for the latest copy of Monitoring Times August 2012. I continue to be very impressed with clarity of the electronic copy downloaded. The text size, the layout, colours etc are all outstanding – a first class job.  
To all those responsible, WELL DONE!*

Regards, Barry, UK

### Subscribe to MT for as little as \$17.95 (U.S. Second Class Mail)

7540 Hwy. 64 W.; Brasstown, NC 28902  
1-800-438-8155 US and Can.; 828-837-9200; Fax 828-837-2216  
e-mail [order@grove-ent.com](mailto:order@grove-ent.com)

|                                | 6 months                          | One Year                           | Two Years                          | Three Years                        |
|--------------------------------|-----------------------------------|------------------------------------|------------------------------------|------------------------------------|
| <b>Electronic Subscription</b> | <input type="checkbox"/> \$17.95  | <input type="checkbox"/> \$19.95   | <input type="checkbox"/> \$38.90   | <input type="checkbox"/> \$57.85   |
| US Second Class Mail           | <input type="checkbox"/> \$17.95  | <input type="checkbox"/> \$32.95   | <input type="checkbox"/> \$59.95   | <input type="checkbox"/> \$89.95   |
| US 1st Class Mail              | <input type="checkbox"/> \$32.95  | <input type="checkbox"/> \$59.95   | <input type="checkbox"/> \$119.00  | <input type="checkbox"/> \$179.95  |
| Canada Surface*                | <input type="checkbox"/> \$22.95* | <input type="checkbox"/> \$42.95*  | <input type="checkbox"/> \$79.95*  | <input type="checkbox"/> \$119.95* |
| Canada Air*                    | <input type="checkbox"/> \$35.95* | <input type="checkbox"/> \$69.95*  | <input type="checkbox"/> \$125.95* | <input type="checkbox"/> \$189.95* |
| Foreign International*         | <input type="checkbox"/> \$30.95* | <input type="checkbox"/> \$58.95*  | <input type="checkbox"/> \$119.95* | <input type="checkbox"/> \$179.95* |
| Foreign Air*                   | <input type="checkbox"/> \$62.95* | <input type="checkbox"/> \$119.95* | <input type="checkbox"/> \$229.95* | <input type="checkbox"/> \$349.95* |

If you order MT Print Edition AND MTXpress Electronic together, MTXpress is only \$11 per year!

\* All payments must be in US funds drawn on a US bank.

MasterCard, Visa, Discover Cards and Paypal accepted!



[www.dxtreme.com](http://www.dxtreme.com) -- Log DXtremely with DXtreme Software!

### Columnist Blogs and Web Sites

These blogs and web pages were created by some of our columnists to better serve their readers. While we highly recommend these resources, they are not official instruments of *Monitoring Times*.

AMERICAN BANDSCAN  
<http://americanbandscan.blogspot.com/> - by Doug Smith

ANTENNA TOPICS  
[www.wa5vjb.com](http://www.wa5vjb.com) - by Kent Britain

BELOW 500KHZ  
<http://below500khz.blogspot.com/> - by Kevin Carey

FED FILES  
<http://mt-fedfiles.blogspot.com/> - by Chris Parris

LARRY'S MONITORING POST  
<http://monitor-post.blogspot.com/> - by Larry Van Horn

MILCOM  
<http://mt-milcom.blogspot.com/> - by Larry Van Horn

SCANNING REPORT  
<http://www.signalharbor.com/> - by Dan Veeneman

SHORTWAVE  
<http://mt-shortwave.blogspot.com/> - by Gayle Van Horn

UTILITY WORLD  
<http://mt-utility.blogspot.com/> - by Hugh Stegman  
[www.ominous-valve.com/uteworld.html](http://www.ominous-valve.com/uteworld.html)

ROSWELL ASTRONOMY CLUB  
ROSWELL, NEW MEXICO

Meets 2nd Thursdays  
Roswell Adult Center,  
Live! Radio Meteor Listening  
[www.roswellastronomyclub.com](http://www.roswellastronomyclub.com)

Profiles in  
Amateur  
Radio  
by Ken  
Reitz,  
KS4ZR

PROFILES IN  
AMATEUR  
RADIO  
By Ken Reitz KS4ZR

A Kindle e-Book, only \$2.99 on Amazon.com.  
Search for book number:  
B0071OT8CO

**Discover Longwave!**  
*BeaconFinder II Directory*

- 100's of beacons
- 75+ pages, 3-hole punched
- Covers 0-530 kHz spectrum
- \$13.95 postpaid

*Sounds of Longwave*

- Hear Natural Radio, Milcom, WWVB, beacons, Euro-BC, Lowfers, more!
- \$13.95 postpaid (specify CD or cassette)

Kevin Carey  
Box 56, W. Bloomfield, NY 14585

**Books by Ernest H. Robl:**

- *The Basic Railfan Book*
- *Understanding Intermodal*
- *The Powder River Basin*

Detailed descriptions at:  
[www.robl.w1.com](http://www.robl.w1.com)

**STEALTH Amateur Radio**

Complete Guide

- Apartments
- Condos
- CC&R Neighborhoods
- Operate from...

ANYWHERE!

[stealthamateur.com](http://stealthamateur.com)

**HUGE 100 PAGE CATALOG**

- Shortwave & Ham Gear
- Scanners & RTTY/FAX
- Antennas & Accessories
- Radio Books & CDs.

Send \$1 to [www.universal-radio.com](http://www.universal-radio.com)

Universal Radio  
6830 Americana Pkwy.  
Reynoldsburg, OH 43068  
Tel. 800 431-3939



# Don't Just Listen...Talk Too!

**Communicate with People Around the World or Around the Corner**

## Join ARRL and Discover the Excitement of Ham Radio

The Amateur Radio Service offers a unique mix of public service, technology and experimenting with electronics – all with an emphasis on fun. Some hams use their skills to provide communications during emergencies and disasters when all else fails. Others enjoy talking to people across the country and around the globe, participating in local contests and building experiments. Whatever YOUR interest, ARRL – the national association for Amateur Radio – has all the resources you need to **get started, get involved** and **get on the air**.

ARRL members have direct access to all the top experts in the Amateur Radio Service. Members enjoy *QST* magazine – ARRL's official journal and the most widely read ham radio publication in the country, free e-newsletters, problem-solving technical advice, access to online product reviews, and much more!

### Special Offer! Free Book for Readers of *Monitoring Times*

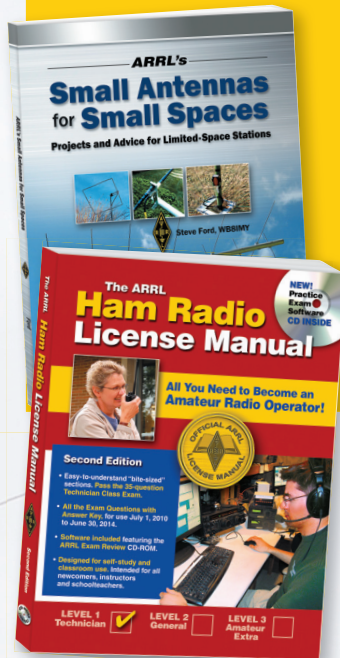

Join ARRL today and get **ARRL's Small Antennas for Small Spaces** book FREE. You'll find ideas and projects that will get you on the air regardless of where you live!

#### Don't have your Amateur Radio license yet?

ARRL can help you with that, too! Join ARRL and get a FREE copy of **The ARRL Ham Radio License Manual** (book with practice exam software). Pass the 35-question license test.

Go to [www.arrl.org/join/MT](http://www.arrl.org/join/MT) or call 1-888-277-5289 to take advantage of these special offers.

**Join  
ARRL  
Today!**

## Learn more about Amateur Radio

Talk, don't just listen. Learn how YOU can become a licensed Amateur Radio operator and get on the air! Discover the benefits of ARRL membership and more by visiting [www.arrl.org/MT](http://www.arrl.org/MT).

**Join Today! Online [www.arrl.org/join/MT](http://www.arrl.org/join/MT)  
or Call Toll-Free 1-888-277-5289**



**ARRL** The national association for  
**AMATEUR RADIO®**  
[www.arrl.org](http://www.arrl.org)



# Icom has the receivers for the experts...

Official Amateur Radio Transceiver Supplier



BOY SCOUTS OF AMERICA®

## IC-R9500 The Ultimate Wide Band Receiver

- 0.005–3335.000MHz\*
- USB, LSB, CW, FSK, FM, WFM, AM
- 1020 Alphanumeric Memory Channels
- P25 (Option UT-122)
- Five Roofing Filters and so much more!



### For those just getting started...



## IC-R75 Wide Band Receiver

- 0.03–60.0 MHz\*
- Triple Conversion
- Twin Passband Tuning
- Digital Signal Processing (DSP)

## AND for those on the go!

### IC-R20 Advanced Ops

- RX: 0.150–3304.999MHz\*
- AM, FM, WFM, SSB, CW
- 1250 Alphanumeric Memory Channels
- Dualwatch Receive
- 4-hour Digital Recorder



### IC-RX7 Track Ready

- RX: 0.150–1300.0MHz\*
- AM, FM, WFM
- 1825 Alphanumeric Memory Channels
- 100 Ch/Second High Speed Scan
- Computer Programmable<sup>2</sup>
- Water Resistance Equivalent to IPX4



### IC-R6 Pocket Compact

- RX: .100–1309.995MHz\*
- AM, FM, WFM
- 1300 Alphanumeric Memory Channels
- 100 Ch/Second High Speed Scan
- Computer Controllable<sup>1</sup>



### IC-R2500 2 Wide Band RX in 1 Black Box

- RX: 0.01–3299.99MHz\*
- AM, FM, WFM, SSB, CW (Main)
- AM, FM and WFM (Sub)
- 1000 Memory Channels
- Optional D-STAR (UT-118)
- Optional P25 (UT-122)
- Optional DSP (UT-106)
- PC Controllable



### IC-PCR1500 PC Control Wide Band RX

- RX: 0.01–3299.99MHz\*
- AM, FM, WFM, SSB, CW
- Record and Save Audio as .WAV File
- USB Cable Connection
- Optional DSP

**Limited Time Only!**  
See your dealer for details.

### Information & Downloads

RECEIVERS | AMATEUR TOOL KIT | COMIC BOOKS | VIDEOS | [WWW.ICOMAMERICA.COM](http://WWW.ICOMAMERICA.COM)

Electronic advertisements feature active links for each radio.

\*Frequency specs may vary. Refer to owner's manual for exact frequency specs. <sup>1</sup>Optional CT-17 required. <sup>2</sup>Optional CS-RX7 required.  
©2012 Icom America Inc. The Icom logo is a registered trademark of Icom Inc. All specifications are subject to change without notice or obligation. 30772

