

WWW.MONITORINGTIMES.COM

Scanning - Shortwave - Ham Radio - Equipment
Internet Streaming - Computers - Antique Radio



Monitoring[®] Times

A Publication of Grove Enterprises

Volume 31, No. 2
February 2012
U.S. \$6.95
Can. \$6.95
Printed in the
United States



Big Repeater in the Sky



In this issue:

- BBC's Big Far East Voice
- AM-DX: Old Service, New Thrills
- MT Reviews: Alinco DJ-G7T Tri-Band HT

AR2300 "Black Box" Professional Grade Communications Receiver

Introducing a new generation of software controlled "black box" receivers!



Available in professional and consumer versions, the AR2300 covers 40 KHz to 3.15 GHz*

With the new AR2300 "black box" receiver from AOR, up to three channels can be monitored simultaneously. Fast Fourier Transform algorithms provide a very fast and high level of signal processing, allowing the receiver to scan through large frequency segments quickly and accurately. All functions can be controlled through a PC running Windows XP or higher. The AR2300 features advanced signal detection capabilities which can detect hidden transmitters. An optional external IP control unit enables the AR2300 to be fully controlled from a remote location and send received signals to the control point via the internet. It can also be used for unattended long-term monitoring by an internal SD audio recorder or spectrum recording with optional AR-IQ software for laboratory signal analysis. The AR2300 appeals to federal, state and local law enforcement agencies, the military, emergency managers, diplomatic service, news-gathering operations, and home monitoring enthusiasts.

Discover exceptional performance, state of the art specifications and a receiver with a menu of optional extras that can be configured to your own needs and specifications.

- Receives AM, wide and narrow FM, upper and lower sideband, CW modes, and optional APCO-25
- Up to 2000 memory channels (50 channels X 40 banks) can be stored in the receiver
- Alphanumeric channel labels
- Fast Fourier Transform algorithms
- Operated by a Windows XP or higher computer through a USB interface using a provided software package that controls all receiver functions
- An I/Q output port that allows the user to capture up to 1 MHz of bandwidth onto a computer hard drive or external storage device
- An SD memory card port that can be used to store recorded audio
- Analog composite video output connector
- CTCSS and DCS squelch operation
- Two selectable Type N antenna input ports
- Adjustable analog 45 MHz IF output with 15 MHz bandwidth
- Optional AR-I/Q Windows software facilitates the easy storage and playback of transmissions captured within up to 1 MHz bandwidth or, signals can be subjected to further analysis.
- An optional GPS board can be used for an accurate time base and for time stamping digital I/Q data.
- The triple-conversion receiver exhibits excellent sensitivity across its tuning range.
- Powered by 12 volts DC (AC Adapter included), it may be operated as a base or mobile unit.
- Software-driven operating selections include IF bandwidth, frequency, mode, filters, a screen-displayed graphical "S-meter," memory inputs, volume and squelch settings and more
- Professional (government) version is equipped with a standard voice-inversion monitoring feature



® The Serious Choice in Advanced Technology Receivers

AOR U.S.A., Inc.
20655 S. Western Ave., Suite 112
Torrance, CA 90501, USA
Tel: 310-787-8615 Fax: 310-787-8619
info@aorusa.com • www.aorusa.com

**Cellular blocked for US consumer version. Unblocked version available to qualified purchasers with documentation. Specifications subject to change without notice or obligation.*

The All-New *EXCELSIOR*™



- 9 kHz to 3.5 GHz
- 16 MHz real-time spectrum
- 1 GHz/s search speed
- 2 simultaneous channels
- USB and PCIe models

Introducing the WiNRADiO G39DDC *EXCELSIOR*.
Is it a great receiver with an added spectrum analyzer?
Or a great spectrum analyzer with an added receiver?

You decide:

www.winradio.com/g39

WiNRADiO® by RADIXON®: Great receivers ahead of their time.™



Cover Story 8
Expand Your Horizons with ISS
2 Meter FM Packet and More!
By Dave Granoff K3AS

Poor band conditions and feeble propagation forecasts don't mean a thing to the many hams around the world everyday who work DX that's out of this world. This month's cover story is about how you can expand your radio horizons by using the big repeater in the sky: the International Space Station.

Sure, we'd all like to chat with astronauts and cosmonauts, but they're usually kind of busy. But, the 2 meter station that's a permanent part of ISS is almost always ready for use. Dave explains how you too can work the space station with little more equipment than you probably already have in your shack.

Dave also shows how to use one of the newest digital modes, JT-65A for Earth-bound weak signal work on HF. That's a mode that's tied to space; it was developed originally for Earth-Moon-Earth (EME) contacts.

On Our Cover

Taken from a window aboard ISS by a member of Expedition Crew 29, the Aurora Australis is seen from a point over the southeast Tasman Sea near southern New Zealand. The station was located at 46.65 degrees south latitude and 169.10 degrees east longitude. (NASA Photo)

C O N T E N T S

AM-DX: An Old Service Yields New Thrills 13
By Doug Smith W9WI

For nearly 100 years the AM band has entertained generations of radio listeners. While each generation finds a new reason for the band, all have shared one common interest with AM: DX. Today, despite noise, interference and other challenges, there's still a lot of DX to be found, including several other countries.

MT's long-time Broadcast Bandscan columnist, Doug Smith, shows us how and when to chase DX on AM, including a rare opportunity to catch DX on frequencies that are ordinarily occupied. Doug also details the best receivers, antennas and accessories you need to tune in for best reception.

BBC's Big Far East Voice 16
By Keith Perron

Rising tall above the jungle canopy of a nature reserve are the massive curtain antennas for the BBC's Far East relay station in Kranji, northwest Singapore. And, inside the long, gleaming transmitter hall are rows of 100 kW vintage shortwave transmitters in nearly showroom condition. This is the heart of the BBC's big voice that brings daily programming to parts of the world that tend to be short of press freedoms, often taken for granted in the West. Keith is given the grand tour and finds out how, even after more than forty years on the air, these transmitters are capable of going another forty.



KF5CRF: Viking Radio Club of Lawton, Oklahoma..... 18
By Clifton Harper KC5YZB

Anyone who has ever tried to introduce a young person to amateur radio knows it's not easy. But, neither is teaching middle school-aged kids in the U.S. But, doing both? That's got to be hard.

Not so, says Clifton Harper KC5YZB who, along with Paul Goulet KC5CY, founded KF5CRF, the Viking Radio Club of Eisenhower Middle School in Lawton, Oklahoma. With only two years under their belts, the two have made an impressive showing with a fine group of young hams eager to embark on a lifelong radio hobby.



R E V I E W S

Alinco DJ-G7T Hand-Held Tri-Band Transceiver 70
By Bob Grove W8JHD

You might expect a hand-held tri-band HT to be versatile but, as Bob explains, this one goes beyond what you'd expect. The Alinco DJ-G7T not only works the amateur 2 meter, 440 and 1.2-1.3 GHz bands, it's also a continuous coverage receiver (less cell phone frequencies) and can search for surreptitious listening devices as well!



CC GOZO AM/FM Radio
By Larry Van Horn N5FPW

CCrane has produced an impressive number of AM/FM radios over the years and Larry tells us this one excels on the FM band with great reception capability and well designed audio reproduction.

MTX PRESS

**SPECIAL
OFFER
BELOW!**

Going **Green** has never been more exciting!

Before the rising prices of gasoline, and before going “green” became a sales pitch, Monitoring Times created MT Express. The full version of the magazine you’ve come to depend on, in full electronic form. Now going into our 11th year of digital perfection, MT Express is better than ever. You get more with our digital magazine than you could ever have with print. The entire magazine is full color. All of the web links are clickable, so if you see a link to a website that you want to visit, just click on it! Want to email an author? Just click on their email address at the top of their column, and MT Express opens your email program, drops in their address, and is ready for your input! All of this, and it’s even CHEAPER than the regular print version! Plus, you’ll get it faster than you would your print copy, no matter where you are in the world. Now is the time to make the switch to digital. Sure, it’s saving a tree and saving some gas, but it’s also getting you what you need, when you want it. Make the switch today.

For a mere \$19.95 U.S., **MT EXPRESS** gives you *Monitoring Times* magazine

- in PDF format viewable with free software, delivered by FTP
- viewable in **brilliant color** (the *whole* magazine, not just what you see in the print version) on your computer screen
- easily navigated by clicking on the Table of Contents
- printable using your own computer printer
- searchable to find every mention of a topic or station schedule
- compatible with software to convert text to audio for sight impaired listeners

To find out if this new subscription is the delivery solution for you, you may download a sample issue for free! Just go to <http://www.grove-ent.com> to find out how.

If you order NOW, you will get 14 ISSUES for the price of 12! That’s right, for only \$19.95 you’ll get an EXTRA 2 MONTHS AND MTXTRA! Just mention code MTFEB12 when you place your order! And, if you order MT Print AND MTXpress together, MTXpress is only \$11 per year!

Now with
MTXTRA

Not only do you now have the complete *Monitoring Times* magazine, in full color, but for no extra cost, we are now adding MTXTRA, which will have a worldwide broadcast guide with ALL offered languages, not just English! So no matter where you are in the world, *Monitoring Times* has something just for you!

GROVE

WWW.GROVE-ENT.COM

800-438-8155

828-837-9200 fax: 828-837-2216





MONITORING TIMES
(ISSN: 0889-5341;
Publishers Mail Agree-
ment #1253492) is
published monthly by
Grove Enterprises, Inc.,
Brasstown, North Caro-
lina, USA.

Copyright © 2012 Grove Enterprises, Inc. Periodicals postage paid at Brasstown, NC, and additional mailing offices. Short excerpts may be reprinted with appropriate credit. Complete articles may not be reproduced without permission.

Address: 7540 Highway 64 West,
Brasstown, NC 28902-0098
Telephone: (828) 837-9200
Fax: (828) 837-2216 (24 hours)
Internet Address: www.grove-ent.com or
www.monitoringtimes.com
Editorial e-mail: editor@monitoringtimes.com
Subscriptions: order@grove-ent.com

Subscription Rates: \$32.95 in US; \$42.95 Canada; and \$58.95 foreign elsewhere, US funds. Label indicates number of issues left. Renewal notice is cover sheet 3 months before expiration. See page 76 for subscription information.

WRITE FOR MONITORING TIMES:
Learn how at
www.monitoringtimes.com/html/write_for_mt.html or
write to editor@monitoringtimes.com

Postmaster:
Send address changes to *Monitoring Times*,
7540 Highway 64 West, Brasstown, NC
28902-0098.

Disclaimer:
While *Monitoring Times* makes an effort to ensure the information it publishes is accurate, it cannot be held liable for the contents. The reader assumes any risk for performing modification or construction projects published in *Monitoring Times*. Opinion or conclusions expressed are not necessarily the view of *Monitoring Times* or Grove Enterprises. Unsolicited manuscripts are accepted. SASE if material is to be returned.

Subscription Questions?
belinda@grove-ent.com

Owners
Bob and Judy Grove
judy@grove-ent.com

Publisher
Bob Grove, W8JHD
bobgrove@monitoringtimes.com

Managing Editor
Rachel Baughn, KE4OPD
editor@monitoringtimes.com

Assistant and Reviews Editor
Larry Van Horn, N5FPW
larryvanhorn@monitoringtimes.com

Features Editor
Ken Reitz
kenreitz@monitoringtimes.com

Art Director
Bill Grove

Advertising Services
Judy Grove
(828) 837-9200
judy@grove-ent.com

TABLE OF CONTENTS

Departments:

Communications	6
Letters	74
Stock Exchange	76
Advertisers Index	76

First Departments

Getting Started	
Scanning Report	20
<i>By Dan Veeneman</i> <i>The Benefits of Sharing</i>	

Ask Bob	23
<i>By Bob Grove W8JHD</i>	

Public service agencies dispatching via Internet; Coax vs. ladder line; Do CFLs really save money; How AM stations survive; Static on 700 MHz; Why AES replaced DES; What happened to car antenna trimmers; Do all cell phone systems use 800 MHz?

Utility World	24
<i>By Hugh Stegman NV6H</i> <i>Beginner's Guide to Funny Noises</i>	

Digital Digest	27
<i>By Mike Chace</i> <i>Moroccan Army Network</i>	

On the Ham Bands	28
<i>By Kirk Kleinschmidt NT0Z</i> <i>The Great Paper Chase</i>	

Beginner's Corner	30
<i>By Ken Reitz KS4ZR</i> <i>More FTA Satellite and Readers' Questions</i>	

Programming Spotlight	32
<i>By Fred Waterer</i> <i>Cruising around the Dials</i>	

Second Departments

QSL Report	34
<i>By Gayle Van Horn W4GVH</i> <i>Rein Main and Special Event QSLing</i>	

English Language SW Guide	35
--	----

MTXtra Shortwave Broadcast Guide ..	47
<i>Chinese/Spanish</i>	

Milcom	52
---------------------	----

By Larry Van Horn N5FPW
Milcom Spectrum Holes

Broadcast Bandscan	54
<i>By Doug Smith W9WI</i> <i>Stations Coming and Going</i>	

Boats, PLANES, Trains	56
<i>By Iden Rogers</i> <i>Getting Your Directions Straight</i>	

Globalnet	58
<i>By Loyd Van Horn W4LVH</i> <i>Radio Doomsday: The end of the world online, Mayan-style</i>	

Below 500 kHz	60
<i>By Kevin Carey WB2QMY</i> <i>RDF-304 Wrap-Up</i>	

Technical Departments

Radio Restorations	62
<i>By Marc Ellis N9EWJ</i> <i>Aligning the Meissner "Broadcast 7"</i>	

Antenna Topics	64
<i>By Dan Farber AC0LW</i> <i>Keep it on the Down Low</i>	

Sky Surfing: Radio Astronomy	66
<i>By Keith Baker KB1SF/VA3KSF</i> <i>Spotlight on VUSAT OSCAR 52</i>	

On the Bench	68
<i>By Mario Filippi</i> <i>Over the Air TV DXing in a Digital World</i>	

First Look	70
<i>By Bob Grove W8JHD and Larry Van Horn N5FPW</i> <i>Alinco DJ-67T Hand-Held Tri-band Transceiver; CC GOZO AM/FM Radio</i>	

What's New	72
<i>By Larry Van Horn N5FPW</i> <i>How to Listen to the World; ARL2300 Ethernet Controller; DXE QSL Scanning Kit; Uniden BC125AT Slated for Release</i>	

You may contact any MT staff writer by email by combining their **first and last name @ monitoringtimes.com**. By postal mail, you may write them in care of MT Headquarters in Brasstown. Please enclose a self-addressed, stamped envelope if you wish the columnist to reply.

Study with the best!
License Study Materials by

Gordon West, WB6NOA & the W5YI Group



TECHNICIAN CLASS



Technician Class book for the 2010-2014 entry level exam! Gordo reorganizes the Q&A into logical topic groups for easy learning! Key words are highlighted in his explanations to help you understand the material for test success. Web addresses for more than 125 helpful, educational sites. Includes *On The Air CD*

demonstrating Tech privileges. **GWTM \$20.95**

Tech Book & Software Package

Gordo's book with W5YI software allows you to study at your computer and take practice exams. Explanations from Gordo's book are on the software – answer a question wrong and his explanation appears to reinforce your learning. Includes free Part 97 Rule Book. **NCS \$29.95**

Tech Audio Course on CD

Welcome to Gordo's classroom! Technician audio theory course recorded by Gordo talks you through the Element 2 question pool. Follows the order of his *Technician Class* book, and is full of the sounds of ham radio operating excitement! An excellent study aid if you spend a lot of time in your car or pick-up! On 4 audio CDs. **GWTV \$29.95**

EXTRA CLASS



Extra Class book Go to the top with Gordo! 2008-2012 book includes all Element 4 Q&A reorganized into logical topic groups. Gordo's fun, educational explanations with highlighted keywords, and great memory tricks for those tough theory questions! Wait 'til you meet "Eli the Ice Man!" **GWEM \$24.95**

Extra Book & Software Package

Study at your computer and take practice exams as the W5YI software scores your results and highlights areas that need further study. Includes explanations from Gordo's book. Free Part 97 Rule Book. **ECS \$39.95**

Extra Audio Course on CD

Extra Class Theory Course recorded by Gordo talks you through the difficult Element 4 theory to help you understand the material and get you ready for your upgrade to the top. On 6 audio CDs. **GWEE \$39.95**

GROL + RADAR



Get your FCC commercial radio licenses and add valuable credentials to your resume! **GROL+RADAR** includes the new FCC Element 1 question pool for the Marine Radio Operator Permit (MROP), the Element 3 pool for the General Radiotelephone

Operator License (GROL), and the Element 8 pool for the RADAR Endorsement. Many employers require these licenses for jobs in marine, aero, safety, and municipal positions. Gordo and his team have written clear explanations for all the Q&A to make studying for these exams educational and fun. If you're an Extra Class ham, many of the technical/math questions will look familiar to you. Fully-illustrated to aid your learning. Book includes a searchable CD-ROM with all FCC Rules for Parts 2, 13, 23, 73, 80 and 87. **GROL \$49.95**

GROL+RADAR book & software package

Enhance your learning experience using our practice exam software along with the **GROL+RADAR** book. Software includes answer explanations from the book – when you select a wrong answer, the explanation from the book appears to reinforce your learning. **GRSP \$79.95**

GENERAL CLASS

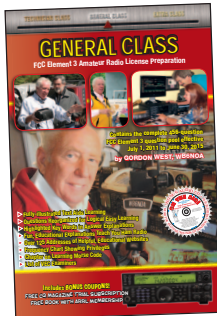

General Class book Upgrade to the HF bands with Gordo & W5YI! Gordo's manual for 2011-2015 reorganizes all the questions into logical topic groups for easier learning. His explanations include highlighted key words to help you remember the material for test success. Companion CD is full of great operating tips! Available about May 1st. **GWGM \$24.95**

General Book & Software Package

Study at your computer and take practice exams. Software includes explanations from Gordo's book, scores your results and highlights areas that need further study. Includes free Part 97 Rule Book. **GUS \$34.95**

General Audio Course on CD

General Theory Course recorded by Gordo is full of the sounds that bring ham radio to life! He talks you through the Element 3 theory to help you understand the material and get you ready for your upcoming exam. On 4 audio CDs. **GWGW \$29.95**

Ham Operator Software has All Exams

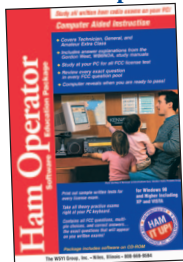

Want to study at your computer without tying up your internet connection? This value pack includes the Tech, General and Extra class exams (Elements 2, 3, and 4) along with a free Part 97 Rule Book. Software includes Gordo's answer explanations from his books! Everything you need to go all the way to the top!

Software only **HOS \$29.95**
 Software with all 3 West Books **HOSB \$89.95**



Using Your Meter

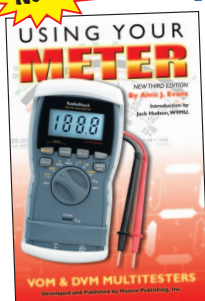

Teach yourself the correct use of your multimeter. Book explains fundamental concepts of electricity including conventional and electron current and series and parallel circuits. It teaches how analog and digital meters work and tells you what the voltage, current and, resistance measurements mean. Then it provides fully-illustrated, step-by-step instruction

on using your meter in practical applications in the home, workshop, automotive and other settings. An excellent learning tool and reference for the hobbyist and ham. **METR \$24.95**

Getting Started in Electronics

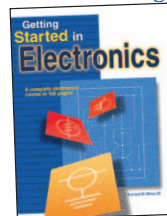

by Forrest M. Mims
 A great introduction for anyone who wants to learn the fundamentals of electronics. Includes 100 projects you can build, and great experiments that demonstrate how electricity works! **GSTD \$19.95**

Engineer's Mini Notebooks

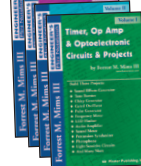

These Mims classics teach you hands-on electronics! Study and build 100s of practical circuits and fun projects. Each volume contains several of his famous Mini Notebooks. Terrific ideas for science fair projects and a great way to learn about electronics!

Useful reference guides for your workbench!

- Vol. 1: Timer, Op Amp, & Optoelectronic Circuits & Projects** **MINI-1 \$12.95**
- Vol. 2: Science & Communications Circuits & Projects** **MINI-2 \$12.95**
- Vol. 3: Electronic Sensor Circuits & Projects** **MINI-3 \$12.95**
- Vol. 4: Electronic Formulas, Symbols & Circuits** **MINI-4 \$12.95**

Order today from W5YI: 800-669-9594 or on-line: www.w5yi.org

The W5YI Group P.O. Box 200065 Arlington, TX 76006-0065

Mention code 053736 for a free gift with your order!



COMMUNICATIONS

by Ken Reitz



AMATEUR/SHORTWAVE

60 Meters Gets a Facelift

After waiting five years for FCC approval, the ARRL's petition to change the rules regarding operating in the 60 meter band has finally been approved. Since its debut in 2003, hams have been allowed to use 60 meters on a very limited basis because of their secondary status on the band which is given to Federal and non-Federal use. Earlier restrictions – five channelized frequencies; 50 watts maximum output and SSB mode only (in upper sideband) – have been changed to allow 100 watts maximum output and digital modes including data, RTTY and CW. One of the original channels, 5368.0 kHz (carrier frequency 5366.5 kHz) was changed to 5358.5 kHz (carrier frequency 5357.0 kHz).

The ARRL explains the change in power restrictions on their web site www.arrl.org, this way, "The effective radiated power limit in the 60 meter band is raised by 3 dB, from 50 W PEP to 100 W PEP, relative to a half-wave dipole. If another type of antenna is used, the station licensee must maintain a record of either the antenna manufacturer's data on the antenna gain or calculations of the antenna gain."

The reason for these restrictions is that amateurs may still use the band only on a secondary basis, which is to say that they may not cause interference to primary users and must accept any interference such users may cause to amateur activities.

BBC's "Arab Spring" Bump

Andy Sennitt reports on his blogs.rnw.nl/medianetwork that according to the Trade Arabia News Service, "Overall audiences to the BBC's Arabic services have risen by more than 50 per cent to a record high of 33.4 million adults weekly – up from 21.6 million before the 'Arab Spring.'" It's no wonder that Iran is anxious to block Arabic programming that it doesn't control that can be received within its borders (see below).

AM/FM/TV BROADCASTING

Radio Seagull Tests 1395 kHz

During a test transmission on 1395 kHz, Euro-broadcaster *Radio Seagull* went to sea for six weeks this past October and November and netted over 600 reception reports, according to their website www.radioseagull.nl. The greatest distance was a listener in Canada. *Radio Seagull* normally broadcasts on 1602 kHz from the ship "Jenni Baynton" which is normally moored in Harlingen Harbor in the Netherlands.



Radio Seagull tests on 1395 kHz. (Courtesy: *Radio Seagull*)

100s of DJs Lose Jobs

Rolling Stone magazine reported in December that two of the top radio station chains in the U.S. fired hundreds of disk jockeys, including LA's legendary Jim Ladd who had worked the LA rock radio scene since 1969, and replaced them with syndicated "personalities."

Clear Channel and Cumulus, which together own nearly 1,000 U.S. radio stations, told the magazine the cuts were not about the DJs. "This is about effectiveness, efficiency and giving our listeners what they want." That's what they think.

The story has a happy ending, at least for Ladd who was picked up by Sirius/XM satellite radio where he takes his free-form rock show nationwide. Listeners will also enjoy hearing interviews with rock legends; relationships Ladd built during his many years in LA. Of course, LA listeners can still hear their radio icon, but it'll cost them.

PUBLIC SERVICE

Encryption Trouble in Winnipeg

According to an article in the *Winnipeg Free Press*, that city's encrypted digital radio system was switched back to analog just two months after being installed. The head of the Winnipeg Police Association was quoted as saying that, "major gaps in the ability to broadcast and receive transmissions were experienced on the encrypted system." Police had earlier cited reception by criminals as the reason for the switch to the new encrypted system.

AP Report: Scanning Now All or Nothing

A widely circulated *Associated Press* article from late November discussed the nationwide quandary public safety agencies are

having with regard to the public's right to know about what's happening in their own cities and towns. Paranoid police departments from around the country are irritated by smartphone apps that turn those phones into scanners, citing them as one reason the departments must opt to encrypt all of their transmissions.

Meanwhile, the article explained, the public and press are irritated that public servants are no longer supervised by their paymasters while they perform tasks on their behalf. The article also mentioned that the rush to keep the public out of police business has resulted in many departments' own frustration at poorly functioning digital encryption schemes that leave everybody unhappy.

SATELLITE

BBG: Stop Iran Sat-Jamming

The *Broadcasting Board of Governors* (BBG), the federal agency that oversees international broadcasting from VoA, Radio Martí, Radio Free Asia and the Middle East Broadcasting Networks (Alhurra TV and Radio Sawa), joined with BBC, Deutsche Welle and other international satellite broadcasters to ask regulatory agencies to take action against the jamming of Persian satellite TV and radio broadcasts. The agency issued a statement saying, "We have seen an escalation this year in the number of pressure tactics that have been used on the media being accessed by audiences in Iran and other countries."

According to BBG, satellite operators indicate that the "interference originates from Iran and is intended to prevent Iranian audiences from seeing foreign broadcasts that the Iranian government finds objectionable."

Keychain Satellites Swarm Lower Space

There's nothing like competition to hone an edge to a college team. But, these teams aren't likely to end up on SportCenter. Universities from all over the world are building

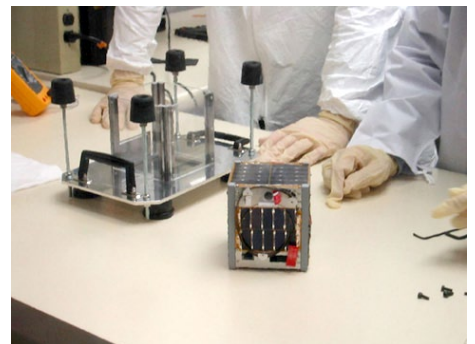

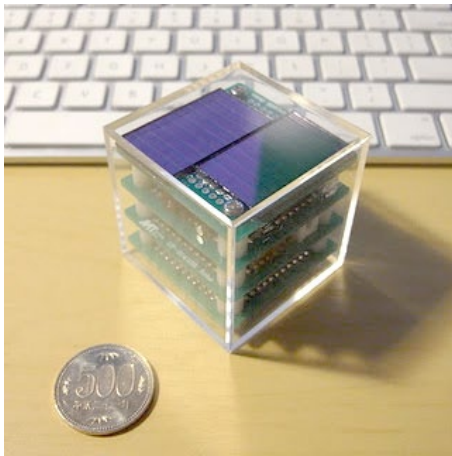

Keychain satellite one of many swarming Low Earth Orbit. (Courtesy: KemushiComputer Inc.)

mini-sats, also known as nanosats, picosats, and now some as small as keychain fobs known as femotosats that provide hands-on experience to would-be NASA or Boeing engineers.

A launch in late October tossed six such U.S. mini-satellites into orbit, including AubieSat-1 (Auburn University), DICE (two dinky satellites from Utah State University), Explorer-1 (Montana State University), M-Cubed (University of Michigan), and RAX-2 (another U of M effort).

It's a great opportunity for monitors around the world to test the capabilities of their listening posts and to provide the universities with much needed data collection. You can track any of the above satellites at www.n2yo.com. Click on "Search Satellite Database" and enter the common name for each. You'll get the NORAD code, international code, orbital status and a link to track the satellite. And, you probably already have all the equipment you need to tune in. Here's a sample: AubieSat-1 transmits 20 wpm CW on 437.475 MHz at just .7 watts while Explorer-1 sends AX.25 FSK 1200 baud on 437.505 MHz at .85 watts.

One Japanese satellite dubbed, "Keychain Satellite," is just five centimeters (about two inches) on a side. You can watch a video of the little bird on a desk dwarfed by an HT here: www.southgatearc.org/news/december2011/keychain_satellite.htm.

Russian General: HAARP Killed Phobos!

Since its failed effort to leave Earth's orbit, would-be Russian Mars probe Phobos had been



HAARP accused of blasting failed Russian Mars probe. (Courtesy: HAARP)

unable to receive ground commands until late November when the European Space Agency's station in Perth, Australia established contact with the stricken satellite. Now, according to a report on *Russia Today*, a retired Russian General speculates that flying over the High Frequency Active Auroral Research Program (HAARP) site in Alaska, may have damaged the craft. He told *Russia Today*, "The powerful electromagnetic radiation of those sites may have affected the control system of the interplanetary probe." There was no apparent response from HAARP public affairs office.

FCC ACTION/INACTION

FCC Revolving Door Cranks Up

The Federal Communications Commission (FCC) is comprised of five commissioners, appointed by the President and confirmed by the Senate, who each serve a five year term, except when filling an unexpired term. The President designates one of the five as the Chairman and there is a requirement that only three commissioners can be from the same political party. This is supposed to provide a more balanced approach to determining FCC policy which covers everything from cable and satellite TV to amateur radio to terrestrial broadcasting as well as certifying thousands of new products for sale.

The issue of who replaces outgoing commissioners will play a decisive role, regarding the future direction of the nation's communications policy. There are a number of hot topics that will no doubt provide the headlines for 2012. Among the issues are a review of media ownership policy, auctioning off the broadcast TV band (if Congress approves it) and everyone's favorite: what constitutes indecency?

As this is written, two commissioners have yet to be officially replaced. Commissioner Meredith Attwell Baker (Republican) resigned in May to become a senior vice-president at cable giant Comcast, a controversial move, since she had earlier in the year participated in a decision from which Comcast was said to benefit. Commissioner Michael J. Copps (Democrat), whose term expired at the end of 2011 was said to promote public interest in broadcast TV and fought against media consolidation. He was the only commissioner of the current five who did not come to the FCC from the wireless telecommunications industry.

President Obama has appointed Jessica Rosenworcel, a former legal adviser to Copps



The commissioners: Clyburn, Copps, Chairman Genachowski, and McDowell. (Courtesy: FCC)

and former communications associate at Drinker, Biddle and Reath, to replace Copps. He tapped Ajit Varadaraj, who had also held previous FCC posts and was a former associate general counsel at Verizon Communications, Inc., to replace Baker.

While both cleared a Senate panel en route to confirmation, final OK could be up in the air as Senator Charles Grassley (R-IA) threatened to put a hold on the nomination of both until he gets satisfactory answers from the White House on whether or not it gave too quick a green light on LightSquared, the company that came under fire from the GPS industry last summer and fall for the potential interference its space and terrestrially based repeaters might cause to consumer's GPS units.

Broadcaster Public Files Policy to Change

The FCC in a late fall meeting has proposed changes to its current requirement regarding public file policy, according to www.broadcastlawblog.com. Among the proposed changes are that the public file be made available online; submitted to and maintained on servers at the FCC, not at the station's own website. The web-based file would exclude letters from the public in order to protect the privacy of those who write such letters. The online public file would automatically import other files required by the FCC to be in the station's file for public viewing.

Gripe, Gripe, Gripe

As if the FCC wasn't swamped by thousands of documents to process, frequencies to police and policy to decide, it also has to maintain a national complaint department. Well, according to an article in the *Kansas City Star*, the Commission seems to have lost the key to that department. The article reports that the FCC now has a backlog of consumer complaints totaling more than 1 million. And, according to the article, ninety percent of those requests are over two years old with "almost all" of those older complaints having to do with... broadcast indecency.

Communications is compiled by Ken Reitz KS4ZR (kenreitz@monitoringtimes.com) from clippings and links supplied by our readers. Many thanks to this month's fine reporters: Anonymous, Rachel Baughn, Bob Grove, Norm Hill, Steve Karnes, Larry Van Horn.

Expand Your Horizons with ISS 2 Meter FM Packet, ARISSat-1 SSTV and JT-65A

By Dave Granoff K3AS

I experience a sense of awe and excitement every time my station computer displays packet messages received from the International Space Station (ISS). Participation in space station communications has added an entirely new dimension to my outlook of the cosmos, radio theory and technology. This addition to my radio hobby makes me feel connected to the space age.

It's amazing that I can contact an inhabited international satellite travelling 215 miles above me at over 17,500 miles per hour (28,000 kph), using only a few watts and a common vertical antenna! Just a few years ago this scenario might have appeared on one of my favorite episodes of *Star Trek*, but today's modern space communications have made this a daily occurrence at my home station. It is inspiring to participate in the evolving technology that has become readily available to radio amateurs and shortwave listeners alike.

Every time I receive live SSTV images of the Earth sent from ARISSat-1 or receive a digipeated packet through the ISS, I am reminded of the first space images sent back to Earth and the moment when man set foot on the Moon. Sometimes it just seems a little more exciting to receive satellite signals in comparison to copying similar data from right here on Earth. This year marked the 50th anniversary of manned space explorations and those endeavors have contributed greatly to the art and science of

radio communications.

Many people follow breaking news about the ISS and take time to read about the other accomplishments of the other space agencies, but are unaware of all options offered to radio enthusiasts.

Some have shied away from exploring satellite communications because of concerns about the setup of dual band operation, the inconvenience of going outdoors with a mobile transceiver or HT, and the costs of adding additional equipment or antennas. ISS packet simplifies the process, by requiring only a simple antenna setup connected to a 2 meter transceiver with an interface device or computer running free software. Likewise, the newly launched ARISSat-1 satellite (August, 2011) transmits live FM SSTV images of the Earth that can also be received on the 2 meter band with readily available software.

ISS voice contacts can be made with the ISS crew members during "free times" in their waking hours from 0700-2200 UTC. A listener can also tune into school classroom educational contacts transmitted from the ISS. The school contact schedule is posted in advance on the ARISS (Amateur Radio on International Space Station) website at www.rac.ca/ariss/. Voice from the ISS is received at 145.800 MHz FM and uplinks are made on 144.490 for Region 2 (the Americas) and 145.20 for Region 1 and 3 (Europe, central Asia, Africa, Australia). ISS conversation is easily heard, but finding an open moment to talk with the Astronauts is mostly hit-or-miss. Packet communications with ground stations, and occasionally the crew, are possible almost every day.

The JT-65A Option

A third mode, JT-65A, though not directly involved with the satellites, also has its roots in outer space communications. Known as the "weak signal mode," JT-65A is extremely useful for terrestrial USB DX work on the HF frequencies. It is a modification of JT-65 which has been used for some time to communicate by meteor scatter propagation and moon bounce. ISS

packet, APRS, and voice communications are accessible to anyone with a 2 meter FM radio. In general, simple vertical antennas connected to the home station will work. Two meter FM packet transmissions require low to medium power, so for mobile access even a handheld radio with a good antenna may suffice.

If you are able to see the ISS travel overhead on a clear evening (it is easy to spot as a bright moving object against a dark background of stars), you might look on in amazement. It is awesome to realize that you are looking at an international scientific community living in outer space for weeks on end. The crew, who are also licensed amateur radio operators, conduct research and find time to operate a ham radio station that actively communicates (both automatically and by schedule) with other amateurs, SWL listeners, school classrooms, and organizations throughout the world. It is truly an inspiring project of technology, dedication, and interest that is shared with the rest of us.

The 2 meter packet digipeater and APRS/bulletin boards are accessible through an Ax .25 (unproto) mode, so we terrestrials can work each other automatically without ID restrictions.

Open protocol allows easy access to BBS (bulletin boards) and mailboxes. To make communications even easier, both TX (transmit) and RX (receive) to the ARISS are conducted on the same simplex frequency at 145.825 FM.



The International Space Station (ISS), also known as Zarya by the Russian Federation, is a joint project of the Space Agencies in the U.S. (NASA), Russia, Japan, Canada, and Europe. It carries three on-board amateur radio stations operated by licensed crew members. (Courtesy: NASA)



NASA astronaut Mike Fossum, Expedition 29 commander, conducts a ham radio session in the Zvezda Service Module of the International Space Station with students at the Kantonschule in Zug, Switzerland. (Courtesy: NASA)

The onboard digipeater operates through a Kenwood TM-D700E radio, and is mostly automated. It is turned on a good part of the time, but is occasionally turned off when the crew conducts delicate experiments, radio broadcasts, or docking maneuvers, and can't risk the RF interference.

The general activity schedule is posted on the ISS Fan Club website at www.issfanclub.com. This site contains much useful information, and offers SWLers and amateurs free membership to participate in the site's posting and "reports" page.

An Orbiting Repeater

FM signals from the ISS travel in straight lines from space station to ground and are not significantly bent by ionospheric layer refractions. So, to access the "bird," it must be above the earth station's horizon with a clear line-of-sight. Watching for the ISS at night is obviously an impractical way to wait for signals, and impossible during daylight. Locating the ISS is accomplished through Internet tracking sites. One must become familiar with interpretation of straightforward orbital data and tracking maps displayed there in order to plan schedules for future close encounters.

Consider the "digipeater" function of the ISS 2 Meter FM station as a rapidly moving FM digital repeater. It is similar to stationary 2 meter repeaters found on terrestrial hilltops, only it travels over 225 miles above the Earth at incredible speeds. Fortunately, Doppler shift plays only a minor role when sending and receiving ISS packet.

Doppler shift of radio signals is analogous to hearing the higher-pitched sound of a car horn that becomes progressively lower as the vehicle speeds by. Radio signals sent from a rapidly approaching satellite are received at slightly higher frequencies from a set reference, and signals sent from a receding satellite are received at lower frequencies. When the craft is directly overhead there is no shift. Maximum deviations for ISS signals are only (+/-) 3 kHz, which are small amounts. Reception is usually satisfactory when the radio is set to the single 145.825 frequency.

However, +/- Doppler offset tuning might benefit weak signal reception when trying to copy at AOS (Acquisition of Signal - as the ISS rises above the horizon) and LOS (Loss of Signal location - when it drops below the horizon). At these elevations the craft is approaching or receding at the highest speeds. Many operators engage the common default incremental tuning settings (+/- 5 kHz found on many radios) when compensation is needed.

A typical 2 meter transceiver is all you need when connected to a simple vertical or circularly polarized antenna of average gain, along with a packet Terminal Node Controller (TNC) or computer with digital packet software, the station is complete. If reception is poor, an in-line preamplifier with low loss coax may help.

When a TNC is not available, a radio connection to a computer running two packet soft-

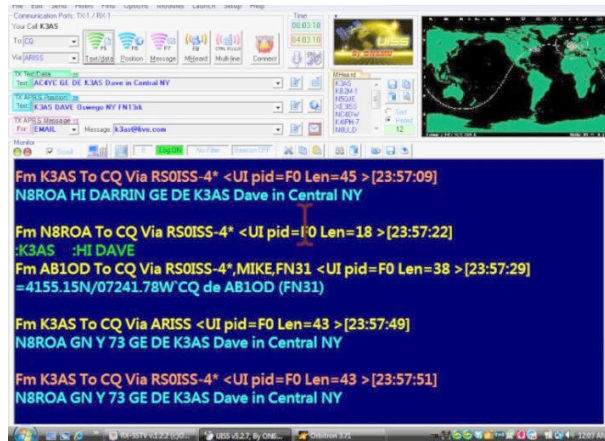

The program is also running the free Orbitron tracking program, which doubles as a screen saver, embedded in the upper right corner. Digipeated messages are brief and color-coded. 'Red' shows successfully digipeated packets from my station that were received and re-transmitted from the ISS. (Courtesy: Author)

ware programs is required. The AGWPE packet engine, by George Rossopoylos SV2AGW, is required to run the UISS packet program written by Guy Roels ON6MU.

Both programs are free, but the "pro" (paid and contribution) versions of AGWPE and UISS respectively, offer greater options. Both are currently compatible with Windows operating systems. A station that is already using other digital sound card modes will find that connections and configurations are similar.

One of the easiest ways to establish sound card in/out and PTT connections between a 2 meter radio and computer is through a sound card interface (such as a SignalLink), but simple shielded cables running between the radio's speaker and mic – and the computer's sound card mic-in jack and phones-out jack – will also suffice, with PTT from the radio's mic pin. An excellent discussion about sound card connections is offered by Ralph Milnes NM5RM at www.soundcardpacket.org.

An efficient antenna is important, but need not be as sophisticated as the satellite tracking systems that are often required for base station amateur satellite work. Elaborate dual tracking rotators are usually not necessary. A popular option is a simple high-gain 2 meter vertical antenna that can be mounted with a clear line-of-sight to the horizon. It should be placed away from buildings, trees, wires, and other obstructing objects. If your current antenna can access most area repeaters, it should be able to work the ISS. I get great results using a 75 foot lead of efficient LMR-400 coax to a Comet GP-6 vertical, mounted alongside the roof of my house.

If you are considering transmitting ISS packet, typical power requirements are 100 watts or less, depending on the efficiency of the antenna. It is recommended that the operator test the packet transmissions by first copying and sending through a local repeater or to another station to check modulation and IMD (inter-modulation distortion). A properly adjusted sound card will maximize connectivity and avoid interference.

Many SWLers and amateurs have had a lot of success using handi-talkies (HTs). Hand-held Yagi antennas, such as the Elk and Arrow, or

extended half to full wave 2 meter whips, work very well. Some newer base HT and mobile 2 meter radios even incorporate built-in TNCs with Ax.25 packet capabilities. In the case of HT's, transmitting with even 5 watts during a high pass when the band is less congested might yield a digipeater "capture."

Tracking the ISS

A very basic understanding of how the ISS orbits around the earth is helpful to understand tracking. The ISS orbits the Earth at an inclination of 52 degrees with respect to the Earth's equator so the extent of orbital latitudes are (+/-) 52 degrees North and South. This trajectory provides coverage to about 90 percent of the world's population. The "period" (duration) of a single orbit is about 93 minutes, and because the Earth rotates counter-clockwise on its axis, a "precession" of orbital paths occurs, placing each new ISS orbital path (-) 26 degrees of latitude (West) of the last one. Precessions cause the orbits to move a full 360 degrees of longitude around the globe every day and are depicted as westward advancing track lines seen on orbital maps.

Websites that track the ISS orbit such as www.n2yo.com and the ISS fan club at www.issfanclub.com, display the orbital path predictions in easy to read tabular data and map forms. An interested operator can go to these sites, enter the home location, and find the data for future passes, reception probabilities and more. These sites also provide interesting updates and information about the ISS crew, space activities, educational programs and other satellite news as well.

SWLers and hams can even configure programs to send ISS pass dates and times, in the form of e-mail reminders and prompts to their computer or smart phone. Some sites like the ISS Fan Club allow amateurs and SWLers to sign up and participate in on-site forums. For additional excellent resources and more advanced data about orbital motions, including the Keplerian elements, see the AMSAT and NASA websites at (www.amsat.org and www.nasa.org).

Rag-chewing between terrestrial stations using the ISS is not encouraged due to high competition for digipeater time on the simplex frequency. The messages between stations are usually short and to the point. Digital packet messages may only include exchanges such as: *Hello K3AS ... UR signal is 59... Name is Dave...* etc. Even so, the successful exchange of short QSO information creates a fulfilling ISS contact.

In a sense, working through the ISS takes on the same kind of excitement that one experiences when working in a DX pile-up. I have personally exchanged many QSL cards that attest to this excitement from stations throughout the U.S. and adjacent foreign countries.

Sometimes stations transmit a web address or leave digital messages in the onboard ISS packet mailbox that can be retrieved by other stations. The message box is also a good way to send correspondence to the crew members.

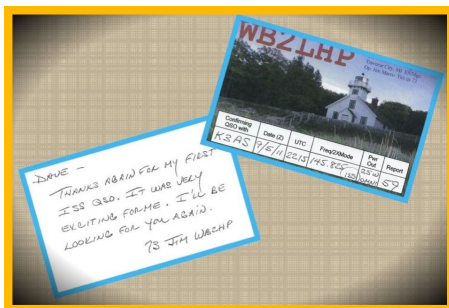

This ISS QSL was sent to me from Jim, WB2LHP from Traverse City, Michigan – over 460 miles away (740 km) – and is a testament to the universal excitement that ham radio operators experience when making contacts through the ISS. (Courtesy: Author)

A special website at www.ariss.net (also called FindU) posts successfully digipeated call signs and packet messages on updated APRS maps, bulletin boards, and call sign lists.

This data comes from packets received by participating on-line stations and is instantly uploaded to the Internet using S-gate and I-gate links. By studying the data, one can review live transmissions and responses received by other stations along the ISS path, including their exact locations, times, and data. The site is often used during a QSO to compare conversational packets received and decoded by the operating station's own software with data received by other near-by stations, so as not to miss any messages. Digipeated data from around the world can be reviewed on the website by anyone.

The dynamics of precession and orbital velocity cause the ISS to pass over a given location at slightly earlier times each day. Regular check-ins at the tracking sites are recommended to note changing trajectories and times. Orbital dynamics bring the ISS within relatively close proximity at a given location twice a day. During those times, there is a group of two to three brief contact opportunities, with each arrival every 93 minutes. Access may last for 5-10 minutes during each pass. Stations at the highest latitudes encounter pass groups almost consecutively, but locations near the equator must wait progressively longer times – up to 10 hours – between groups. Because the ISS access times are so brief, an operator must be ready for action when the ISS arrives!

To make contacts, you must wait for suitable overhead passes. For the base station with a fixed vertical antenna in a clear line-of-sight, you mostly need to know the times of near passes. If you intend to use an HT outdoors you also need to know in which direction to point the portable antenna. Besides using the website maps and pass prediction sites previously discussed, mobile ISS tracking apps, including VosWorx, are available for smart phones like the iPhone4.

Pass elevations are very important. For good results, a rule of thumb is to glean predictions

on the websites and look for passes with 25-75 degree elevations over your location. Zero degree elevations denote angles of approach and recession at the horizons, and near 90 degree elevations refer to passages that are very high overhead. With successively higher elevations, the duration of access time to the digipeater increases – allowing up to 10 minutes for contacts. During higher passes, the ISS is closer and signals do not have to travel as far, making reception better. Sometimes, though, polarization issues with a vertical antenna may produce signal nulls during very high passes greater than 75 degrees.

Inside the Footprint

So, how far will the ISS 2 Meter FM digipeater expand your DX horizons? Besides communicating with the spacecraft, you can conduct two-way contacts with stations that are separated by considerable distances. The footprint is known as the circular communications range of the ISS as it moves over the Earth's surface. Average stations should be able to hear (and work) the ISS when they are within this footprint.

Because the ISS orbits at an average of 215 miles (344 km) above the earth, the footprint typically extends to a radius of about 1100 miles (1,760 km) in all directions. In order for two stations to communicate effectively and exchange contact information in real time, they must both be within the footprint's coverage area. Contacts as far away as New York to California, for example, are possible, spanning 2200 miles (3,520 km).

In order to make DX contacts, it is necessary to review upcoming orbital details (pass elevations as well as N-S-E-W directions) and select pass predictions that will present optimized opportunities. This is a fun project for DX hunters. A similar triangulation technique is done when working DX locations through terrestrial repeaters as well. Initially, these steps seem like complicated preparations to go through, but after a few trials, they can be accomplished by simply glancing at the maps and tracks.

Five to ten minutes before I begin operating ISS packet from my home station, I run through a basic checklist. These simple procedures are done in advance of the approaching ISS so I am ready for immediate receive and transmit when the sta-

tion enters the 5-10 minute footprint. Favorable pass arrivals have already been determined before. Screensavers and active tracking programs like Scott Hather's Satscape and Sebastian Stoff's Orbitron 3.71 can be run in the background to watch for approaching passes and can be used as additional tracking maps. Orbitron can be configured to load neatly into the image window of the UISS packet program.

Here's how to do it:

- Open the Internet browser, connect to The ISS fan club at www.issfanclub.com, and find "countdown until arrival time" and note the active – on or off – status of the ISS packet radio.
- Open the www.n2yo.com live tracking site, and click the footprint setting to visualize the moving track and coverage area of the approaching ISS.
- Open the FindU site at www.ariss.net to enable quick reference to APRS reporting and gated packet messages of live transmissions.
- Tune the radio to 145.825 FM Simplex, and adjust the power to 50 W or less.
- Start the AGWPE packet engine and UISS packet software (or TNC hardware)
- Check the UISS software TX windows to be sure that correct transmitting addresses to the ISS digipeater have been configured.
- Set the "To" window in UISS at "CQ" and "Via" window at "RISS".
- At this point, the station is ready for an approach. Simple TX messages may include a CQ or other salutation/comment, station call sign, locator in a 4 or 6 digit format (FN13rk for instance) and perhaps the operator's name, city/state and a brief message. Short message formats are encouraged. Once the digipeater is within range, signals should begin to register on the S-meter and data should start to display across the UISS screen.

Besides making contacts through the ISS, much can be learned about satellite communications by following the various activities conducted on board the craft. Many activities sponsored by the ISS crew and NASA pertain to SWL and amateur radio projects. Progress updates from NASA, AMSAT, and The ISS Fan Club provide an opportunity to become informed about the latest in space exploration, education, and development on a global scale.

In addition, numerous monitoring and operating awards are available from the ARRL, ARISS, and others, including QSL cards, acknowledgements, and contact credits.

ARISSAT-1: A New (and short-lived) SSTV Ham Satellite

ARISSat-1-KEDR was launched into space from the cargo hold of the ISS by the expedition crew 28 in August 2011. Developed by AMSAT, it is designed to transmit four types of signals: FM, CW, BPSK and, (voice) telemetry. KEDR, meaning "cedar," is the Russian co-name for the project. It was the original radio call sign of Russian cosmonaut Yuri Gagarin.

According to the ARRL website at www.arrl.org/news: "FM transmissions - will cycle between a voice ID as RS01S, select telemetry values, 24 international greeting messages in 15 languages, and SSTV images."

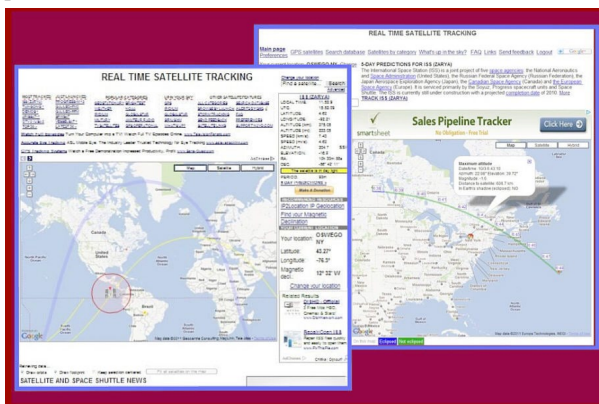

Examples of satellite tracking and predictions maps. Note the red 'circle' in the left image which represents the communications range or 'footprint' of the ISS. Lighter yellow line to the left of the circle denotes a 'precession' path of the next orbit. (Courtesy: www.n2yo.com)



There is also a student research project on board to monitor vacuum levels in space at different altitudes as the satellite de-orbits, and a CW beacon that transmits bulletins and code practice. ARISSat-1 is also used for teaching students about satellites, research, and communications at various educational levels in courses and live classroom demonstrations around the world.

The satellite follows a low earth orbital trajectory much like the ISS, and transmits FM SSTV images on 145.950 MHz in between voice greetings, announcements, and a "secret" code word. Full power transmissions are easily copied while the satellite is in direct sunlight, and it is set into a very low power sleep mode to conserve power when in Earth's shadow. Waiting for passes in full sunlight assures the best chances for successful copy, especially with an HT.

The secret words embedded in the voice transmissions can be redeemed for award certificates from AMSAT at www.arissat-1.org. Other awards are also available for copying CW and

receiving SSTV images.

Receiving the ARISSat-1 voice messages and SSTV images is very straightforward. The same station and antenna configuration previously discussed for ISS packet also applies. SSTV transmission is heard on 145.950 FM. A new, free SSTV receiving program called Rx SSTV is available at Guy Roels' UISS site. Other recommended SSTV programs include Makoto Mori, JE3HHT's MMSSTV, HRD/DM-780, Chromapix, and MixW (for Windows). MultiScan is written for the Mac. I might refer the reader to my own website at www.k3as.com for further discussion about ARISSat-1, ISS packet, and SSTV configurations and resources.

Stunning examples of received images submitted by SWLs and amateurs can be found on AMSAT's 'ARISS SSTV' website at www.amsat.org/amsat/ariss/SSTV/. You can track the ARISSat-1 by visiting tracking sites previously mentioned above in the ISS section. If you don't have a radio-to-computer connection, you can still decode received SSTV audio signals sent from any SSTV transmitted source, including ARISSat-1, by recording the audio signals heard in the radio's speaker and then playing the SSTV sound recordings back to a computer's microphone.

I have successfully decoded images by recording SSTV transmissions from my HT or home station with my iPhone recorder app, and then played them back to my personal laptop running the Rx SSTV program. When the software input is configured for mic/line in and mic levels are set to 100%, the images begin to appear. You can practice by recording USB signals from the

popular HF SSTV frequency at 14.230 MHz. Try it!

JT-65A – The Weak Signal Mode

Coming back down to earth, it is noteworthy to discuss the next digital mode, JT-65A, which has been expanding the horizons for HF DX. This mode was originally developed as the weak signal mode for HF moon-bounce communications. With JT-65A it's easy to work stations around the world with only a few watts and a modest antenna, including stealth or attic antennas. Weak signals can be copied as low as SN -25 dB which makes them nearly inaudible to the human ear and almost invisible on a tracing screen.

Transmit power requirements are in the milliwatts to 50 watt range. It is not uncommon for me (and I know we are in a sunspot upswing, but nonetheless) to work Australia, New Zealand, Japan, Europe, Africa, South America, and throughout the U.S. all in one day, on 20 or 15 meters with a JT-65A station operating an inverted V wire antenna, a Kenwood TS-2000, and runs 25 watts.

JT-65 was developed in 2001 by Joe Taylor, K1JT, a Professor Emeritus in Physics at Princeton University, as a special digital mode application for VHF and HF EME (Earth-Moon-Earth or moon bounce) and high speed meteor ionization (meteor scatter) communications. In varying formats it has been used on the 2 meters, 6 meters and the HF bands. JT-65A uses phase-shift keying and is transmitted in MFSK fashion, with a tonal vocabulary has been expanded to include

MT Anthology 2011

you can copy and paste any information, including frequencies, from any issue into any Windows-based program! You can even print articles or frequency lists right from the program. All of this is available now, so order yours today!

Subscriber Special: If you are a current Monitoring Times subscriber, you can get this disc for only \$14.95, and as an extra bonus, we'll ship it to you FREE (USPS First Class)! This applies to ANY of the past Anthology CDs, so complete your library today!

Want more?

The COMPLETE *MT Anthology* for the MT 1999-2008 of *Monitoring Times*, on ONE DVD! Fully indexed and searchable, every issue is in full, high resolution color! This will quickly become your "go-to" reference for your radio hobby. This complete DVD houses in it every review, every frequency chart, every article, every feature... every item that has been in *MT* since 1999! The value of this package is well over \$500, but can now be yours for only \$79.95. Even if you own the paper copies of *MT*, you'll find this compendium to be the perfect addition to your ever-growing library.

NOW AVAILABLE!

The COMPLETE, 30th year of Monitoring Times Magazine is now available, in beautiful, full-color, high-resolution! The entire year is indexed for fast, efficient searches for any keyword or frequency. Not only that, but

Order SFT-27-11

Only **\$19.95** plus \$3 shipping
(\$14.95 and FREE SHIPPING in the U.S. for subscribers)

- Order SFT-27-11 (2011)
- Order SFT-27-10 (2010)
- Order SFT-27-09 (2009)
- Order SFT-27-08 (2008)
- Order SFT-27-07 (2007)
- Order SFT-27-06 (2006)
- Order SFT-27-05 (2005)
- Order SFT-27-04 (2004)
- Order SFT-27-03 (2003)
- Order SFT-27-02 (2002)
- Order SFT-27-01 (2001)
- Order SFT-27-00 (2000)
- Order SFT-27-99 (1999)



**10-year DVD:
Order SFT-27-DVD - \$79.95**

Grove Enterprises, Inc - www.grove-ent.com
(800) 438-8155; (828) 837-9200
7540 Hwy 64 W; Brasstown, NC 28902

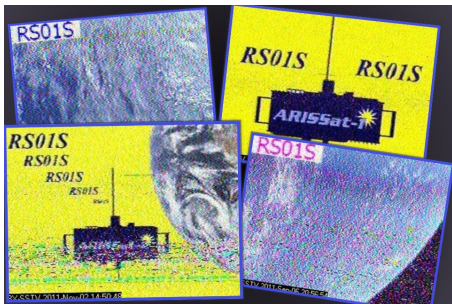

ARISsat-1 SSTV images: These images were received using ON6MU's Rx SSTV program. The antenna is a Comet GP-6 Vertical, with 6 dB gain, mounted on the rooftop at 30 feet. A location with an unobstructed line of sight to the horizon will yield the best satellite reception. (Courtesy: Author)

65 alphabet letters, punctuation, and numbers.

Forward Error Correction (FEC) uses compression of digital bits and Reed-Solomon encoding to ensure an all-or-none decoding accuracy. Signals from QRP transmissions can be successfully decoded many DB below the noise floor, and JT-65A delivers a substantial improvement of weak signal copy over other popular modes. Single Sideband (SSB), for instance, requires a SNR (signal to noise ratio) of +6 dB to get good copy, and CW can be barely copied when it is -15 SNR below the noise floor.

The noise floor is defined as the sum total of background noises from all sources including atmospheric, cosmic, component, etc. JT-65A tones, though very weak at -25dB, can be reliably decoded when no other signals are heard on the band. Activity is found on all the HF bands from 160-10 Meters.

Operating JT-65A

JT-65A protocol involves exchanging short messages lasting one minute each. 42 seconds is devoted to transmission and the remaining 12 seconds is reserved for decoding and response time. A typical QSO lasts about 6 minutes including 3 exchanges between each station. Stock or modifiable messages contain up to 13 characters and spaces per transmission. (Those who are used to Twitter, IM, or ISS packet, will feel right at home with this brief format!) Stations usually exchange call signs, SN levels (substituted for RST), acknowledgments, brief station stats, and short 73's.

The station setup for JT-65A requires the JT-65HF program by Joe Large, W6CQZ. This popular application is specially designed for HF work and is written for Windows. It can be downloaded at <http://hflink.com/jt65/>.

A sound card with shielded connections from radio speaker output and computer mic

28.076	7.076
24.920	7.039
21.076	7.036
18.120	3.576
14.076	1.838
10.139	1.805

JT-65A (USB) operating Frequencies in MHz



Russian cosmonaut Sergei Volkov, Expedition 28 flight engineer, poses for a photo with the KEDR satellite in the Zvezda Service Module of the International Space Station. (Photo courtesy: NASA)

input, or an interface, is needed. The software has an excellent instructional "Help and setup" section. Transmission and reception are carried out in USB and bandwidth should be set to 2-3 K. Minor sound card settings can be adjusted on the software dashboard. Other software options include the original WSJT by Joe Taylor, K1JT, and MultiPSK by Patrick, F6CTE. Computer requirements include a processor with a minimum capacity of 1.5 GHz to handle the multi-decode feature.

The radio is tuned to an allocated frequency, and the intuitive and automatic software takes over from there. Entire QSOs can be conducted with simple clicks of the mouse. Pre-configured transmission templates are automatically populated and activated by clicking on received messages. Message customization is easily entered from a keyboard.

The interactive screen displays a passband of multiple signals and a running list of all received messages, similar to the PSK "super browser" found in HRD/DM-780. The received, sent, CQ, and other station messages are color-coded for easy identification. With actively configured locator coordinates and an Internet connection, the software will send received call signs to an internet site called PSK reporter.

By logging into <http://pskreporter.info/pskmap.html>, PSK Reporter will display various locations around the world where your transmitted signals have been received. This is a fantastic way to check band propagation. The site is free for anyone to use, and both SWL monitors and amateur radio operators can participate in the reception reporting system by registering their stations on the website.

One must have a very accurate computer

clock to operate JT-65A. Clock accuracy is necessary for synchronization and decoding of transmissions. If computer time is off by even one or two seconds from WWV or National Standard, decoding may not occur. To assure accuracy, most computers require the installation of an additional time sync program. Free software programs such as Symmtime and Dimension4 are available for download.

There are many excellent resources published on the Internet, in forums, and in publications to assist the interested SWLer and amateur with these digital modes; just Google your favorite word or phrase. Digital mode improvements

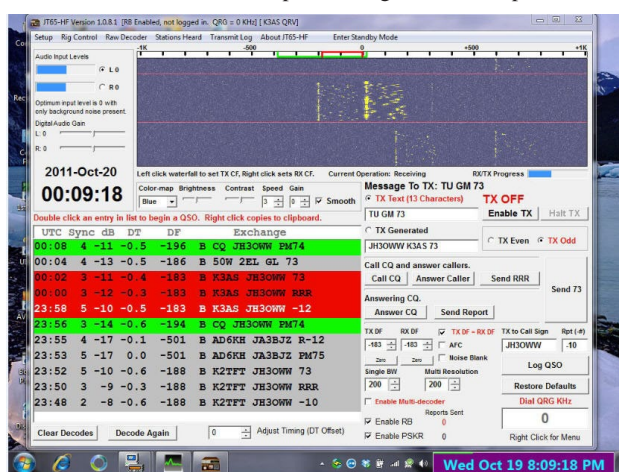

are rapidly evolving and becoming main stream alongside the more conventional modes. I have found that the digital modes in this article have definitely added diversity to my list of station capabilities and lend a certain sense of exotic, high-tech excitement to my everyday operating activities.

There is no doubt that ISS packet, ARISat-1 SSTV, and JT-65A have expanded my current radio horizons. As Mr. Spock would have said ... "Fascinating, Captain!"

AM DX: An Old Service Yields New Thrills

By Doug Smith W9WI

The AM DX hobby was born of necessity. The stations that did exist in the 1920s and 1930s weren't on the air 24 hours a day, or even seven days a week. If you lived in Presque Isle, Maine, or Wausau, Wisconsin, or Cheyenne, Wyoming, or any of hundreds of other cities across the country, and you wanted to listen to radio, you had to DX. There weren't any local stations in your area. Stations that engaged in special late-night broadcasts would receive mail from all parts of the U.S. and the occasional foreign country.

Today, most parts of the country receive a half-dozen or more AM stations. Add FM, and TV, and radio via the Internet and AM DX is no longer a necessity. It remains, however, a popular and rewarding hobby. For some, DXing is a way to hear interesting programming from distant cities. For others it's about collecting stations, and for some, it's a technical hobby, a way to perfect antennas, receivers, and listening techniques.

Noise and Interference Challenges

AM DXing isn't about turning on the radio, hearing a nice, clean, strong signal, writing down the call letters, and going on to the next target. You have to work for your DX. There are a number of factors that make DXing a non-trivial pursuit; tactics you can employ to work around – or take advantage of – each of these challenges.

The radio dial has become a noisy place over the years. When broadcasting started, the only use for electricity in the typical home was lighting; even the radio was powered by batteries. Today, we have a never-ending supply of electrical devices: TV sets, blower motors in the furnace, computers, cell phone chargers, cable boxes, hair dryers, etc., etc. All of it generates noise and all of it interferes with weak DX signals.

The FCC calls computers "unintentional radiators." Radio stations – intentional radiators – also contribute to the challenge of digging out that rare DX tidbit. At the beginning of World War



This may be the strongest source of interference to distant AM signals: your computer. (Courtesy: Author)

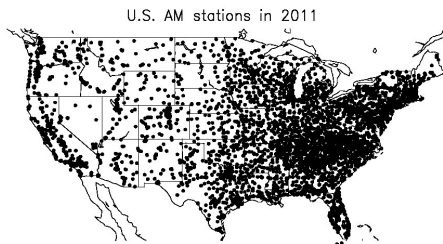
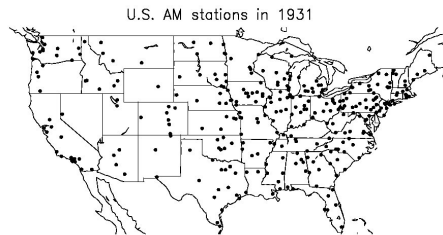

The AM dial is a lot more crowded than it was 80 years ago! (Courtesy: Author)

II, there were six stations operating at night on 1260 kHz. Today, there are 55. DXers who were active in the 1960s tell of hearing a 250-watt Honolulu station in the eastern U.S.; today, even 10,000-watt Hawaiian stations are rarely heard east of California.

Another type of "intentional radiator" has appeared in the last few years. Stations transmitting In Band On Channel (IBOC), also known as HD Radio®, transmit a digital signal in channels either side of a station's nominal analog frequency. For example, the WBZ-1030 kHz digital signal occupies not only the 1030 channel, but also 1020 and 1040.



HD Radio is a significant source of interference on the AM band. (Courtesy: Ken Reitz KS4ZR)

In other words, the first challenge in DXing AM is not making weak signals strong enough to understand. It's separating a desired signal – which may be fairly strong – from an undesired signal on the same frequency which may be even stronger. Read on for information on equipment

and antennas for pulling DX signals out of the hash of noise and cacophony of interference.

Station Identification

Hearing a DX signal is one thing; identifying it is something completely different. Amateur stations identify frequently (it seems the only thing many hams ever transmit are their call letters!) Some broadcast stations are proud of their call letters as well; others, not so much so. The FCC says stations are supposed to identify "...as close to the hour as feasible..." These days that could mean 15 minutes or more from the hour. That's assuming the station bothers to identify at all.

Listen for local commercials. Radio listenership is highest in the morning, as people drive to work; and in the afternoon, as they drive home. These are also the most productive times for DXing; this is when local advertisers are most likely to want their commercials aired, and when stations are most likely to be broadcasting local news, weather, and especially traffic reports.

¿Habla Español?

Broadcasting in a language other than English dates back to the earliest days of the U.S. radio industry. Of course, if you wish to listen to stations outside the United States, the ability to deal with foreign languages is an absolute necessity.

Don't give up on a foreign-language station simply because you don't understand the language. Sometimes, the language itself is a clue; there is a limited number of Oriental-language stations broadcasting on 1430 kHz. U.S.-based stations often identify in English on the hour. Advertisers on these stations may broadcast their commercials in a foreign language, but the street on which the advertiser's business is located is almost certainly named in English. You can often



Polish-language programming on 1450 AM may be from this Chicago station. (Courtesy: WCEV)

identify the station by the locations of advertisers' businesses. Here's an AM DX tip: Google is an invaluable tool for the DXer!

Stations that Shouldn't be There

When I got into the broadcasting business in the late 1970s, we lived in fear and respect of the FCC. Nobody would dream of intentionally ignoring a regulation. The idea of operating at night under a daytime-only license would never have crossed our mind. Those days are over.

Stations operating outside the terms of their license are both a boon and a bust for DXers. On the negative side, they generate interference for desired DX catches, especially when it's one of your local stations ignoring the regulations! On the positive side, this illegal operation makes it possible to hear stations you wouldn't be able to hear if they were compliant with the law.

Friday evenings, during high-school football season, can be a very productive period for this type of listening. Many stations seem to believe it's actually legal to use daytime facilities at night to carry the games (it isn't). These broadcasts are full of local commercials and mentions of the teams playing. In some areas, high-school basketball can also result in signals that shouldn't be there.

Sometimes, this kind of operation can be legal. Stations are allowed to broadcast with their higher-powered daytime facilities at night when necessary for disaster relief or avoidance. When there's severe weather in parts of the country, try looking for DX stations from those areas. On occasion, the disaster is far more local – the station itself has suffered a tower failure. Counter-intuitively, this may result in a better signal in some distant locations.

Regulations also allow for technical tests in the early morning hours. On occasion these tests may be run for the benefit of DXers. These "DX Tests" usually include extra identification announcements, as well as distinctive music and, often, identification in Morse code. Hams can tell you Morse will often get through a noisy, interference-laden channel when voice transmissions won't.



These stations in Maryland and New Mexico were received in Tennessee during DX Test broadcasts. (Courtesy: Author)

Holes in the Dial

Of course, you can't DX a station that

isn't on the air. For decades, a radio station license was said to be "a license to print money" but that's no longer the case. AM stations are gradually disappearing in the U.S., going off the air and returning their licenses to the FCC. In Canada, dozens of AM stations have converted to FM. There are now no full-power AM stations left on Prince Edward Island; New Brunswick and Nova Scotia are probably not far behind. Mexico has a formal program to move AM stations to FM.

One listener's "silent" station was someone else's "intentional radiator." When major stations are off the air, their channels are prime ground for digging up exotic distant signals. As I'm writing this, the 50,000-watt powerhouses on 690 and 940 in Montreal are off the air, and DXers are reporting some interesting signals on these frequencies. Both frequencies will be reactivated later this year, putting an end to these special opportunities.



Powerful stations on 690 and 940 in Montreal are off the air, opening unusual DX opportunities. (Courtesy: Info 690, CBC)

Superior DX Receivers

Obviously, DXing the AM dial requires a radio, and you can log DX with any AM receiver; your car radio is a very good place to start. You'll log more DX (and more interesting DX) with a better receiver. In general, receivers that perform well for shortwave DX will also prove worthwhile for AM DXing. Try to stick with receivers with digital tuning. Identifying your DX can be difficult enough; adding uncertainty as to what frequency you're DXing will be frustrating.

Portable Receivers

Sangean has come out with a number of interesting portable sets. The current model is the ATS909X; see last November's MT for a brief review by Ken Reitz (page 10) and a lengthier story by Bob Grove (page 70). This receiver has Digital Signal Processing (DSP), a feature that can provide absolutely amazing selectivity (the ability to separate stations on nearby frequencies) and noise reduction.



Other current portable receivers that see frequent mention include Tecsun and Grundig units, and the CCRadio (C. Crane). The Sony ICF-2010 is probably the best regarded of the discontinued portables though, unfortunately, some have suffered a number of failures. I carry a Radio Shack DX-398 on vacation, and have Grundig's older YB400.

Desktop Receivers

Again, the criteria for a good AM DX receiver are the same as those for a good shortwave receiver. Icom receivers have been popular for

years; the R-75 is their current unit. You'll find digital signal processing in this receiver as well (look for this feature in any current tabletop receiver). Alinco's DX-R8T/E is worth a look, too; Ken's November 2011 quick review also covers this radio.



Among discontinued receivers, the Drake R-8 is by far the most popular. Any of the older Icom, Kenwood, or Yaesu desktop receivers are well worth a look (however, none of these older receivers offers DSP). "Boat anchor" receivers – vintage sets that use vacuum tubes – are popular with DXers. But, they probably aren't a good idea unless you have some experience working on tube gear, and a reliable supply of spare tubes.

Software Defined Receivers (SDRs)

If you've been reading MT for any length of time, you've certainly read about the newer software-defined radios (SDRs). Many of the jobs normally performed by hardware circuitry within a traditional receiver are instead handled by software running on an external computer.



As noted above, DSP is a valuable function for the AM DXer and SDRs offer an additional advantage: the DSP can be easily modified and updated by the listener. DSP technology in a portable or desktop receiver is frozen in place when the receiver is manufactured. In a SDR, it isn't. Processing updates can be downloaded from the Internet.

SDRs also offer extra information about the signals received. A so-called "waterfall" display shows weak signals that may be buried in the interference – such as carriers from overseas stations. Precise frequency measurement, when correlated with readings from other DXers, may make it possible to identify signals that can't even be heard.

AOR and Winradio are among suppliers of software-defined receivers. Ken's November review covers AOR's AR2300. See the Grove website for information on Winradio's five receivers with AM broadcast coverage.

Antennas for Different Locations

All radio reception requires some type of antenna. While the AM dial is full of noise and interference, the most effective way to get rid of it is with a directional antenna. These antennas receive better from some directions than others. The idea isn't so much to bring up the signals of stations you want to listen to, as to knock down the signals that are interfering with them.

Unfortunately, the size of a directional antenna is inversely proportional to the frequency you're trying to receive, and the AM band is relatively low in frequency. A three-element Yagi antenna for the 2-meter ham band would be roughly 3 feet long and 3 feet wide. The same

antenna for the 19m shortwave band would be about 30 feet by 30 feet. For the bottom of the AM broadcast band, that antenna would be nearly 900 feet on a side! Luckily, there are some smaller alternatives.

Virtually all portable receivers contain an internal AM antenna. It consists of several hundred turns of very fine wire around a ferrite core. These antennas receive fairly well in most directions – and very poorly in a narrow band of directions. On most sets, the directions of poor reception are off the right and left side of the radio. Try rotating the radio to weaken the noise.

Desktop and software-defined receivers will require an external antenna. Compact loop antennas will often provide excellent reception. Some are wound on ferrite cores, like the internal antennas in portable receivers. Others are “air wound,” on a frame, usually wood. Either way, you want to point the direction of poor reception at the noise source. These antennas are also useful with portable receivers.

If you have the space, an outdoor antenna is well worth the effort. “Pennants,” “Flags,” and “K9AY Loops” are among the antennas popular with DXers. All of these are constructed with a few hundred feet of wire and a few electrical components. Commercially-manufactured controllers are also available.

The “gold standard” for AM receiving antennas is probably the Beverage, named after its inventor Harold H. Beverage, and having nothing to do with liquid refreshments, adult or otherwise. This antenna is a single wire, supported a few feet above ground, and at least one wavelength long. Unfortunately, at the bottom of the AM band, one wavelength is 550 meters – or nearly 1,700 feet. If you’re lucky to have enough room for such an antenna, point it in the direction you wish to receive.

AM DX Accessories

AM DXers can make use of many of the same accessories enjoyed by shortwave listeners. Probably the simplest, though also probably the most important, is a decent set of headphones. You don’t want noises in your listening room to interfere with the distant AM signals; there’s already more than enough interference arriving by radio!

Noise eliminators are popular with some DXers. These units use a second antenna to intentionally receive noise – and then use that noise to cancel out the same noise received via the main antenna. The Timewave ANC-4 is one model of noise canceller; MFJ’s 1026 is another, although the MFJ unit requires modification to work in the AM band.

External DSP audio filters can be useful. Digital noise reduction can be amazingly effective, though more aggressive filtering can result in a rather robotic quality to the audio. International DXers will appreciate automatic notch filters, which will eliminate the high-pitched whine that results from the mixing of foreign and domestic signals.

One of the more important accessories is the computer! Of course, a computer is invaluable for looking up information about your DX targets, your equipment, and DXing techniques.

Interfacing your computer to your radio can greatly increase your totals as well. Timed recording software like Total Recorder allows unattended DXing; you can set your computer to record the hourly identification announcements, or to catch a special 3:00 a.m. test broadcast. Audio editing software like Audacity can remove noise from recordings and trim them for posting to Internet sites where others may be able to help identify your DX.

Interesting Aspects and Subplots

AM DX is not a monolithic hobby. There are several subplots to the pursuit, enough to keep your interest regardless of the time, money, and space you’re able to devote.

Some DXers chase international reception. Obviously, Canada is easy reception in most parts of the U.S. If you can work past the language barrier, Cuba and Mexico are both easily and frequently heard. Crossing the oceans to Europe or Asia is a much bigger challenge. Listeners within a few miles of the coast may have some success (see the sidebar for frequency suggestions). Listeners anywhere east of the Rockies can probably hear the 1 kHz heterodyne tone generated many nights by a 2 million watt station in Saudi Arabia. Listen for BSKSA on 1520 kHz. Foreign “hets,” as they are known, are possible on other frequencies as well.

Getting Away from it All

As mentioned earlier, many of us live in rather noisy locations. One way to clear up the noise is to use directional antennas and digital noise reduction. Another way is to move the equipment away from the noise. Some listeners engage in “DXpeditions,” trips made for the primary purpose of DXing.

An annual trip by veteran DXers to Newfoundland has resulted in signals from exotic locations like India and Argentina. I’ve engaged in expeditions much closer to home; a public park may be an excellent location for a listening trip. Listeners near the coasts may find traveling just a few miles to the beach could result in an amazing improvement in foreign signals.

Most of us have a car and with it we can, with little effort, travel fifty miles in an hour or so. Making the trip by bicycle takes four or five hours and leaves us exhausted. Yet, many car owners do ride bicycles dozens of miles.

“Ultra Light” DXing is a recent development that captures the same spirit. These DXers are interested in catching unusual reception on usual receivers. An Ultra Light Radio (ULR) is an inexpensive consumer receiver that fits in a shirt pocket. You probably won’t hear the same exotic DX you might have had on an expensive tabletop receiver and 1,000-foot Beverage antenna. However, the thrill of receiving an Illinois station 500 miles away on a shirt-pocket radio can match the thrill of receiving a British signal on a \$2,000 receiver with a 400-foot antenna.

AM DX is one of the oldest radio hobbies and for a 90-year-old, it’s still in pretty good health! There are plenty of interesting catches out there. Give it a try!

Here are just a few of the frequencies you might check for DX from outside the U.S.:

East:

621 (Canary Islands, Spanish)
670 (Cuba)
740 (Canada)
860 (Canada, French)
1053 (TalkSport, U.K.)
1089 (TalkSport, U.K.)
1134 (Croatia)
1180 (Cuba)
1540 (Canada, multilingual)
1620 (Cuba)

Central:

540 (Canada, CBC Radio 1)
730 (Mexico)
800 (Mexico)
960 (Canada, “The Fan” sports radio)
990 (Canada, CBC Radio 1)
Also, try the Cuban frequencies mentioned above.

West:

612 (Australia)
690 (Canada, CBC Radio 1)
690 (Mexico)
774 (Japan)
1090 (Mexico)
1130 (Canada, “News 1130” Vancouver)

URLs for this Article

Clubs:

www.nrcdxas.org - National Radio Club
www.ircaonline.org/ - International Radio Club of America

Station references:

www.mediumwave.de/ - A German site listing European AM stations
www.nrcdxas.org/catalog/books/index1.html - NRC AM Radio Log
www.fcc.gov/mb/audio/amq.html - FCC AM Query
Google is an invaluable source for identifying your AM DX!

Receivers:

www.dxer.ca/file-area/cat_view/87-ultra-light-radio-files-area - A variety of information on Ultralight Radio DXing

<http://gnuradio.org/redmine/projects/gnuradio/wiki> - GNU Radio, an open-source Software Defined Radio

http://monitoringtimes.com/html/body_all_reviews.html#Shortwave%20Receivers1 - Monitoring Times past reviews of shortwave receivers. Shortwave receivers are generally also good choices for AM

Antennas:

www.k7tjr.com/rx1comparison.htm - A comparison of several types of AM receiving antenna
www.dxing.info/equipment/ewe.dx - A simple “EWE” antenna

Software:

www.totalrecorder.com/ - Total Recorder, software for making unattended recordings
<http://audacity.sourceforge.net/> - Audacity, software for editing recordings

Articles & Miscellany:

www.dxing.info/dxpeditions/newfoundland_17_dx - The report from a 2006 AM DX expedition to Newfoundland
www.nautel.com - 1 kW-2 MW AM transmitters, for use overseas
<http://americanbandscan.blogspot.com> - Doug Smith’s AM DX blog



The BBC's Big Far East Voice

By Keith Perron
(Photos Courtesy: Author)

Kranji, located in Northwest Singapore, speaks to the world. This suburb, located twenty-two kilometers from the city center, is named after a local tree called the kranji. It's the home of the BBC Far East Relay Station and they broadcast daily to Southeast Asia, East Asia, Central Asia, East Africa, Australia and New Zealand. For those who have not been fortunate to visit a shortwave transmitter site, you're missing a chance to see something truly amazing.

But, first we need to go back to the 1960s. Before the site in Singapore was built, the BBC World Service had used Malaysia as a base to reach its audience. But relations between the UK and Malaysia started to turn sour and around 1964 the Malaysian government kicked the BBC out. This was just around the time Singapore was expelled from Malaysia. The BBC needed to find a location that could offer excellent coverage so, they turned to Singapore.

In 1965 Singapore was not the bustling metropolis it is today. It was, for the most part, still countryside. Kranji in the Northwest of the city-state was chosen due to its prime location. Today Kranji is a reserve park and is protected, so it more or less looks as it did back in the '60s.



Satellite dishes to downlink BBC programming are in the foreground with the shortwave curtain antenna in the background. Note the elevation of the dishes are nearly straight up this close to the equator.



Massive BBC Far East Relay Station curtain array dominates the landscape.

Building the relay station was a huge undertaking for the BBC. Everything from the transmitters, antennas, and the winches to lower and raise the massive curtain antennas had to be sent from the UK. This was at a time when there were almost no roads in Kranji. But before anything was installed the transmitter hall needed to be built. So, in mid 1965 they started construction on the hall which is replica of the Woofferton site in England.

The transmitters in the hall are Marconi BD272 250 kW and Marconi 50 kW. The 50kW transmitters are still used today, but only as back-ups if there is a problem with the high-powered ones. Even after more than 50 years these units are still in tip-top condition.

During non-prime time hours two to three of the transmitters are running. At prime-time hours all 10 are on the air, beaming programs around the world. But, broadcasts are not just from the BBC. They also transmit programming from Deutsche Welle, Radio Netherlands and others. There is only a period of 3 hours each day when none of the transmitters are on air and this is one of the few times that staff have to perform regular service.

If a transmitter does need to be serviced during a scheduled block of time, they switch



In the main transmitter hall with Cindy Yao, the manager of the station, the author and Tam Lam Soon, the chief engineer who has been with the station for over 20 years.

to a back-up or another transmitter that is not being used. This may sound easy, but it's not. The BD272 transmitter first needs to be cooled down for a minimum of 15 minutes. Then the very large, hot coils need to be removed by hand and replaced with ones for the correct frequency. The day I visited the site it was a very comfortable 31° C (about 88° F), but inside the hall it was 39 (over 102° F).

One of the most impressive things about the site is the antenna farm. The taxi driver told me he didn't know where it was, but I told him just take me to Kranji. As we got closer to the site, the antenna farm started to appear as a monster coming out of the sea. The site is massive – and I mean massive. The curtain antennas just take your breath away. What makes it more impressive is the backdrop of palm and coconut trees that give it an almost jungle like feel.

With transmitters and antennas installed over 50 years ago, how does the station manage to stay in tip-top condition? Simple: the station has a very dedicated staff, one that loves what they do. As an example, there are many transmitter parts that are no longer available, but the engineers at the station design and build their own replacements, except for the main transmitter tubes that still come directly from the UK.

The day I was there, they were in the process of replacing the insulators for the main cables that feed the antennas. The ones they designed themselves are in fact better than the ones originally installed. The engineers told me that despite the fact the station has been on air for over 50 years, it's so well maintained it could operate for another 50 years.

Cindy Yao, the manager of the station, was hired in 1966 as a secretary. Tam Lam Soon was hired at the station 25 years ago after his military service. He joined as a junior engineer and today he is the chief engineer. Both told me the same

thing; they find it amazing that this small corner of Singapore sends out shortwave programs that are heard by millions of people, as well as leading political and human rights advocates like Aung San Suu Kyi in Burma and artists like Ai Weiwei in China, just to name two.

Cindy told me she has seen so many changes in how programs are received and re-transmitted. At one time programs were received off shortwave and then fed to the control room

after some cables were patched in and the programs were on the air. Today, programming is taken off the satellite including a backup ISDN line from London. What I found interesting is that there was no shortwave radio at the site!

When I was walking with the head engineer, Tam Lam Soon, I asked him about the challenges in keeping the station on air. "Singapore is very lucky geographically," he said. "There are no typhoons, because it's less than 80 miles from the equator. Earthquakes almost never happen and when they do, they are so small no one really notices them."

The big problem they do have is lightning during monsoon season. On average they get 1 or 2 direct lightning strikes a year. As we were walking further away from the main transmitter hall and closer to the jungle he mentioned another problem; crocodiles! Yes crocodiles are seen on the grounds of the station at certain times of year. In fact, Tam told me that just a few days before I arrived some crocodiles got into the site. He said he was replacing a tube in the transmitter they call Sender 102 when two engineers, who were outside up a tower, started yelling for help because there were two crocs four meters below them.

Of all the relay stations I have visited in my professional radio career, from the old Flavo site in Holland once used by Radio Netherlands, Sackville in Canada used by Radio Canada International, or the Bauta site in Cuba used by Radio Havana Cuba, the BBC Far East Relay Station is by far the one I am most impressed with. If you're going to be in Singapore I would suggest you give them a call and organize a visit. Cindy and Tam love to have visitors and take so much pride in the station that a visit to Singapore would not be complete unless you drop by for a cup of tea.



The transmitter hall with rows of 100 kW and 250 kW Marconi transmitters. These are the originals that were sent to Singapore in 1964 and installed in 1965. Tam told me this station could operate for another 40 years with no problems. What you don't see are three 50 kW Marconi transmitters in the back that are used for backups in case anything was to happen to these giants

KF5CRF: Viking Radio Club of Lawton, OK

By Clifton Harper KE5YZB
(Photos Courtesy of the Author)

The club station for the Viking Radio Club at Eisenhower Middle School in Lawton, Oklahoma operates as KF5CRF. And, along with our Radio in the Park project, the club is a continuing process that has evolved over two years into a regular on-air event.

KF5CRF began with the purpose of exposing middle school aged students to real life applications involving math, science and electronics, using amateur radio as a fun way to gain their interest. Over that short period of time KF5CRF has become a workable program involving the school, parents and local hams. But, to grow into the program that KF5CRF has become was hardly an accident.

I, along with my cohort Paul Goulet KC5CYY, have spent hours planning and strategizing different ways to develop the program into a workable system to train new hams and expose students to a new method of learning. It all began as an effort by two individuals who saw a need to revive amateur radio and expose the sciences to the youth.

I began the Viking Radio Club at Eisenhower Middle School in 2009 and attempted to teach and expose the students to amateur radio, but I was limited on time. There was only twenty minutes available each Thursday morning and maybe a few minutes after school. Meanwhile, Paul had been endeavoring to reach the youth and get public exposure for amateur radio at a local park on Saturdays. As chance would have it, the two of us met and discovered what each of us was doing; the opportunity to work together was irresistible.



KF5CRF at a local park called Kid's Zone. We try to go there every Saturday, weather permitting, to practice hands-on radio with the students.



Viking Radio Club's new Technician licensees: (from back row) Laura KF5NNU, Thomas KF5NNR, Isaiah KF5NNQ, Tristan KF5NNP, Mr. Harper KE5YZB, (front row) ShKyra KF5NNT, Kameron KF5NNS, Itzel our new Extra KF5JAZ and, holding our newly won November Sweepstakes plaque, Marcos KF5LLG.

I needed more time and Paul wanted more participation, so we talked about the possibilities we could achieve together and plans were made. It was going to happen, but it wasn't easy. Paul had not realized the magnitude of time he and I would soon be devoting to the kids and amateur radio. He was shocked to learn it wouldn't be just an occasional Saturday, but every Saturday. And, since the decision was made to begin working together, with few exceptions the Vikings have been present in the park learning about amateur radio, developing confidence, becoming comfortable talking on the radio and making their presence known on the air.

The Club Expands!

Club growth has been constant, as interest is continually ignited and a new member joining the club is a regular occurrence. As other students learned about the radio club and what club members were able to learn and do, they also wanted to join. KF5CRF started with around twenty members and student involvement is now about fifty with many more wanting to join.

As an example of how students learn and develop, one sixth grade girl, during the first year of the club, received her Technician license and soon after had her General. She has now accomplished getting her Extra class license exactly 364 days after getting her Technician license; her name is Itzel KF5JAZ.

The club has received a lot of recognition since its inception and along the way has been commended by an official observer for good radio practices. Our 12 year-old sixth grade Extra Itzel was nominated for Young Ham of the Year last year and even received an A-1 Operator recommendation as well. The club has also received a plaque for its participation in the 2010 November Sweepstakes.

Much progress has been made since the club's beginning two years ago, but there are still many more goals and achievements looming on the horizon.

Part of the School Curriculum

A tremendous opportunity came to the club in May of 2011, when, after researching laws and regulations for over the previous year, I developed a curriculum for a world communications class that would align itself with the state-mandated education standards. I made a proposal to the District Education Improvement Council to include the class in the offered curriculum and demonstrated how it would enhance and enforce the standards mandated by the state.

Realizing the opportunity to have a class that developed, proved and enforced real life applications of core curriculum classes such as math, science and geography, the Council, which



Viking Radio Club in action. Pictured left to right, standing is Paul KC5CYY, Isaiah KF5NNQ, leaning on table Mr. Harper KE5YZB, Micah, Itzel KF5JAZ, Marcos KF5LLG.

controls local curriculum, unanimously approved the proposal. The superintendent allowed the class to become part of the local curriculum.

Adding this class meant that students interested in amateur radio could take a regular elective class and receive a credit while at the same time receive five hours per week of intensive study involving amateur radio. In the three and a half months since the class began in August of 2011, the class has produced six new hams and one Extra. The approach we use is just good old fashioned teaching and hands-on participation.

The club still meets weekly for those students who are not able to take the class and Paul meets with the club on Thursdays and stays around for the first hour to work with the students. Radio time in class is spent learning FCC regulations and electronics along with Morse code and studies from the ARRL manual. Students are encouraged to continue their education at the park on Saturdays where they receive a great deal more time on the air.

Help from Local Hams

Something that has contributed to the growth of KF5CRF has been the strong bond with local hams and clubs as well as hams and clubs from

FREQUENCY CHART

You can work the schools and clubs of this month's School Club Roundup on the following frequencies (30, 17 and 12 meters are traditionally off-limits during contests):

160 Meters: 1800-1810 (CW kHz) 1855-1865 (Phone kHz)

80 Meters: 3530-3540 3850-3880

40 Meters: 7030-7040 7225-7255

20 Meters: 14030-14040 14250-14280

15 Meters: 21130-21140 21300-21330

10 Meters: 28130-28140 28440-28460

Also look for SCR activity in the PSK31 and RTTY portions of the above bands. Stations will typically call, "CQ SCR."

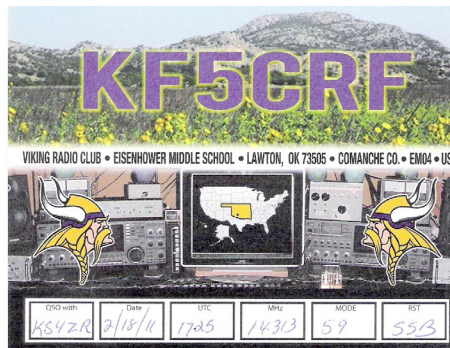

QSL card from Comanche County, Oklahoma: KF5CRF, the club station of Eisenhower Middle School in Lawton, Oklahoma. (Courtesy: KS4ZR)

around the country. Two local clubs, W5KS and WX5LAW, support the efforts and goals of the program every chance they can. Paul learned that the international ham radio organization OMIK was working to expand youth involvement in amateur radio and he joined them. As a result, they often help the club while it is on the air and many of their members regularly talk with KF5CRF students.

Another group that supports us on the air is K8DAR, the Boys and Girls Club of Menominee, Wisconsin. They have the same goals as Viking Radio and we often talk and exchange ideas working together on the air with our students.

Mentioned above are established groups, but we cannot leave out hams from around the world who have discovered us on the air and supported the Vikings by checking into the weekly Saturday Outreach event at the local park. Stations as distant as South Africa have been heard trying to make contact with the park station.

Although most contacts are new, there are dedicated handfuls that regularly check into the net and commend and encourage the students to keep going and to get their licenses. Imagine the pleasant surprise and feeling of achievement in

VIKING RADIO CLUB AND THE SCR

Last October the Viking Radio Club participated in the fall semester School Club Roundup (SCR) scoring 140,000 points through 625 QSOs using 23 operators. They worked 48 states, five Canadian provinces, eight clubs, 30 schools and five countries.

The club uses an Icom 706 and a Hustler 5BTV HF vertical antenna, purchased through an ARRL grant, mounted on the roof of the school. The club has also used the ARRL grant to purchase a Kenwood TS-590s.

The students did much better this year than in the past, and each year they progressively get better and their scores increase. The students enjoy the competition immensely. They seem to feel the rush of adrenaline as the contest progresses and strive to make every contact with those faint school calls they hear. Every contact counts and they realize professionalism and efficiency in contact routine is a must.

This month the club will try again to be on or near 14.295 MHz as they were for the October SCR and will be trying some new strategies as they modify and change their program, tweaking it to make their routine better. The winter term SCR is held the first full week of February and this year it will be from the sixth through the tenth.

School club trustee and one of the club's Elmers, Clifton Harper KE5YZB, said, "My cohort Paul Goulet KC5CYY and I are very resourceful and have a lot of personal equipment that the club uses. However, I have sold suckers and Pixy Stix at school and raised enough money to buy an Ameritron ALS 600. How many suckers and Pixy Stix do you suppose that took? Paul and I have also purchased equipment out of our own pockets such as a tuner to work with the ALS 600 and a HyGain antenna to use at the park that we can easily taken down."

The club is also in the process of signing up for the International Space Station's program for school contacts.

the students when they can reply that they already have their own call sign!

Funding for our program is sourced outside the school. In most instances schools will not have the funding available. Our equipment is on loan or owned by either Paul or me. But, the club recently received a grant from the ARRL with which we purchased a new radio and antenna that is being set up at the school. Though cost of books and equipment can be a factor for most programs, our club has held fund-raisers and received donations that help toward those purchases.

Paul and I feel that *time* is the greatest investment that can be contributed when children are the center of focus. Those associated with KF5CRF believe time invested with our children now will be rewarded exponentially with the success of those children whose lives we have touched. The key, we have found, to making all this happen is just to provide an opportunity for interested youth.





The Benefits of Sharing

In this era of shrinking tax revenue and increased scrutiny of public expenditures, sharing the cost of radio systems among multiple agencies makes good fiscal sense. This month we take a look in detail at one such system in Illinois and mention plans for a major change in California.

❖ DuPage County, Illinois

DuPage County lies immediately west of Chicago in northeastern Illinois. It is home to nearly a million people and covers more than 300 square miles. Within the county there are nine townships and more than a dozen distinct municipalities, many of which operate their own radio systems. At the present time there is no common countywide radio network, but it's not for a lack of trying.



In September of 2006, the DuPage County Emergency Telephone System Board (ETSB) approved a \$7 million contract for a nine-tower, five-channel radio system with Motorola. The goal of the new system was to allow police and fire departments to share a common radio network, replacing the patchwork of small, independent VHF and UHF systems used by individual agencies. The 2006 contract called for the new system to be completed in ten months. The ETSB made a justification that they could issue the contract as "sole source," meaning that they did not have to go out and get competitive bids.

In June of 2008, Motorola officially informed the ETSB that they needed more time and more money to complete the work and the Board approved an increase in the contract amount to \$13.6 million.

In December of 2010, the ETSB finally decided that they would not be able to complete their new system and instead voted to do two things. First, they increased the contract amount to \$28.6 million and second, they agreed to allow DuPage County to join the Illinois statewide public safety radio system called STARCOM21.

Conveniently for the Board, Motorola operates STARCOM21 on behalf of the State of Illinois, so again competitive bidding was avoided. The cost of the contract will be borne by county residents through 911 wireless surcharge fees.

In January of last year, Motorola was unable to meet the first milestone of the contract and did not deliver 1,800 of the 3,400 radios ordered by the county (at a cost of about \$6,000 each). In November, DuPage County announced that it would miss the "go live" target date of December 1, 2011 and set a new deadline for the end of 2012. The head of the ETSB blamed red tape and delays within the county bureaucracy, not Motorola.

The Federal Communications Commission (FCC) license database shows the ETSB holds licenses for eight repeater sites on the following frequencies: 769.33125, 769.75625, 770.05625, 770.80625, 771.10625, 771.43125, 772.05625, 772.45625, 772.93125, 773.48125, 773.73125, 774.18125 and 774.43125 MHz. Presumably these frequencies will be added to the STARCOM21 system, at least in the Chicagoland area.

❖ Sharing the Cost

DuPage County has two large consolidated dispatch centers that provide communications services for multiple public safety agencies. Instead of each municipality setting up their own operations center with dispatch consoles, radios and associated equipment and staff, many towns and villages got together and formed shared centers to serve their communities, allowing them to reduce labor costs and avoid duplication of expensive equipment.

The DuPage Public Safety Communications (DU-COMM) is a Public Safety Answering Point (PSAP) located in Glendale Heights that receives 9-1-1 telephone calls and dispatches police, fire and emergency medical services (EMS) for 34 agencies in the northern part of the county.

Police agencies and their associated unit identifiers served by DU-COMM:

Town	Unit Identifier
Bartlett	"Bravo"
Carol Stream	"Charlie"
Darien	"John"
Elmhurst	"Echo"
Glen Ellyn	"Golf"
Hanover Park	"Yankee"
Lisle	"Adam"
Lombard	"Lincoln"
Oakbrook Terrace	"Ocean"
Roselle	"Robert"

Villa Park	"Victor"
Warrenville	"Delta"
West Chicago	"Zebra"
Wheaton	"Tango"
Winfield	"William"
Woodridge	"Sam"

In addition, DU-COMM provides dispatch services for the following fire and EMS agencies: Addison, Bartlett, Carol Stream, Darien, Elmhurst, Glen Ellyn, Glenside, Hanover Park, Lombard, Lisle, Oakbrook Terrace, Roselle, Villa Park, Warrenville, West Chicago, Wheaton, Winfield, Woodridge and York Center.

Southwest Central Dispatch (SWCD) is based in Palos Heights and serves more than a dozen suburban communities to the south and west of Chicago. It was formed in 1985 and dispatches the following DuPage County police departments: Burr Ridge, Clarendon Hills, Hinsdale and Willowbrook.

❖ Cross-band Interoperability

There are an enormous number of conventional (non-trunked) analog frequencies in use in DuPage County. Because there are so many disparate, independent systems operating in different frequency bands, the county established the DuPage Interoperability Radio System (DIRS), which has the capability of linking VHF (Very High Frequency), UHF (Ultra High Frequency) and 800 MHz repeater traffic. This cross-band interoperability allows public safety agencies that use different frequency bands to communicate with each other.

Frequency	Description
158.790	DIRS VHF Patch
470.2625	DIRS UHF Patch (Channel 16)
855.6375	DIRS 800 MHz Digital (Project 25) Patch
855.6375	DIRS 800 MHz Analog Patch

Frequency	Description
37.94	DuPage County Emergency Radio Network (DCERN)
37.96	County Highway Department
39.98	County Highway Department
44.76	Bloomington Park District
44.96	Bloomington Park District
45.36	Illinois Emergency Management Agency (Dispatch)
45.40	DuPage Medical Emergency Radio System (DMERS)
45.44	Illinois Emergency Management Agency (Tactical 2)
45.56	National Weather Service Spotter Network
45.68	Milton Township Public Works
46.58	Wood Dale Public Works
151.025	Township Public Works (Bloomington, Downers Grove, Lisle, Naperville, York and Winfield Townships)
151.055	Naperville Township Public Works
151.145	Lisle Park District



151.220 Park District (Downers Grove, Wheaton)
 151.235 Park District (Addison, Wheaton)
 151.265 Lombard Park District
 151.295 Bartlett Park District
 151.310 Naperville Park District
 151.370 Roselle Park District
 151.385 DU-COMM Fire South (Darien, Lisle, Warrenville, Woodridge)
 151.415 Westmont Park District
 151.475 Glen Ellyn Park District
 151.490 Wheaton Park District (Aquatic Center)
 151.655 Hanover Park Park District
 153.635 Shared Fire Dispatch (Burr Ridge, Clarendon Hills, Darien, Downers Grove, Hinsdale, Oak Brook, Westmont, Willowbrook)
 153.830 DU-COMM Fireground
 153.920 Wheaton Public Works
 154.040 Public Works (Elmhurst, Villa Park, Winfield)
 154.085 Hinsdale Sanitary District
 154.100 Naperville Emergency Management Agency (Tactical)
 154.115 Carol Stream and Oakbrook Terrace Public Works
 154.175 DU-COMM Fire North (Bloomingdale, Carol Stream, Glen Ellyn, Glendale Heights, West Chicago, Wheaton, Winfield)
 154.250 Shared Fire Dispatch (Burr Ridge, Pleasantview, Willowbrook)
 154.265 Northern Illinois Fire Emergency Radio Network (NIFERN)
 154.280 DU-COMM Fireground
 154.310 DU-COMM Fire West (Bartlett, Hanover Park, Itasca, Roselle, Wood Dale)
 154.370 Bensenville Fire (Dispatch via NorComm)
 154.415 DU-COMM Fire East (Addison, Elmhurst, Lombard, Oakbrook Terrace, Villa Park, York Center)
 154.475 Illinois State Police Emergency Radio Network (ISPERN)
 154.650 Westmont Police (Tactical)
 154.725 Shared Police Dispatch (Downers Grove, Oak Brook, Woodridge Westmont)
 154.770 County Office of Emergency Management (Tactical 1)
 154.815 Westmont Police (Tactical 5)
 154.875 SWCD Police Car-to-Car
 154.890 Addison Police (Car-to-Base)
 154.965 Emergency Management Agency (Bartlett, Naperville)
 154.980 Public Works (Darien, Hinsdale)
 154.955 Darien and Woodridge Fireground
 154.965 Main Emergency Operations
 155.010 Shared Police (Addison, Bensenville, West Chicago, Woodridge)
 155.025 Emergency Services Mutual Aid Radio Network (ES-MARN)
 155.040 Woodridge Police (Alternate)
 155.055 Illinois Radio Emergency Aid Channel (IREACH)
 155.085 Bloomingdale Public Works
 155.100 Police (Car-to-Car) (Glen Ellyn, Lombard)
 155.145 Shared Police (Burr Ridge, Glendale Heights, Westmont, Willowbrook)
 155.235 County Office of Emergency Management (Tactical 2)
 155.2375 Downers Grove Fire (Training)
 155.430 County Office of Emergency Management (Tactical 3)
 155.520 Shared Police (Bloomingdale, Hanover Park, Roselle)
 155.565 Wheaton Police (Alternate)
 155.670 Bartlett Police (Car-to-Car)
 155.685 Police (Hinsdale, Westmont)
 155.7075 Downers Grove Fire (Dispatch)
 155.715 Roselle Public Works
 155.745 Warrenville Police (Car-to-Car)
 155.760 Naperville Emergency Management Agency (Patch to adjacent county)
 155.805 Public Works (Itasca, Oak Brook)
 155.835 Darien Fire (Dispatch via Lemont in Cook County)
 155.880 West Chicago Public Works
 155.895 Hanover Park Public Works
 156.105 Wayne Township Public Works
 156.150 Downers Grove Police (Car-to-Car)
 156.195 Lisle Public Works
 156.600 Lombard Park District (Water Park)
 158.160 Bensenville Public Works / EMA / Police: Car-to-Car
 158.730 Oak Brook Police (Car-to-Car)
 158.745 Westmont Police (Tactical 2)
 158.835 Westmont Police (Tactical)
 158.910 West Chicago Emergency Services Disaster Agency (ESDA)
 159.105 Glen Ellyn Public Works
 159.225 Park District (Bensenville, Oakbrook Terrace, Wheaton)

159.285 Oak Brook Park District
 159.630 Addison Public Works
 220.8025 DU-COMM Fire Station Alerts (East)
 220.8175 DU-COMM Fire Station Alerts (North)
 220.8325 DU-COMM Fire Station Alerts (West)
 220.8475 DU-COMM Fire Station Alerts (South)
 451.4000 Westmont Emergency Management Agency
 451.5375 Naperville Utility Crews
 452.3125 Naperville Utility Crews
 453.0125 Bensenville Emergency Management Agency (Operations)
 453.0500 Downers Grove Public Works
 453.2875 County Health Department (Wheaton)
 453.3875 Elmhurst Public Works
 453.4500 Darien Public Works
 453.5125 Lisle Emergency Management and Town Operations
 453.8000 Darien Public Works
 453.8500 Juvenile Detention Facility (Channel 1)
 453.8750 Emergency Services Disaster Agencies (Statewide)
 457.6000 Juvenile Detention Facility (Channel 2)
 458.0125 Bensenville Emergency Management Agency (Operations)
 458.0250 Wheaton Park District
 458.0875 Glen Ellyn Park District
 458.1250 Wheaton Park District
 458.6625 Glen Ellyn Park District
 460.5125 Glendale Heights Fire (Range Extenders)
 462.3875 Bensenville Burglar and Fire Alarm Monitoring (Telemetry)
 465.4875 Wheaton Park District
 465.5125 Glendale Heights Fire (Range Extenders)
 465.5500 Wheaton Park District
 465.5375 Elmhurst Fire and Security Alarms (Digital Telemetry)
 470.0375 DU Police (Elmhurst Tactical Channel 1)
 470.1875 Police (Lombard, Villa Park)
 470.2875 Wheaton Police (Tactical)
 470.3125 DU-COMM Channel 7 West (Police) (Warrenville, West Chicago, Winfield)
 470.3625 Interagency Fire Emergency Radio Network (IFERN)
 UHF Patch
 470.3875 DU-COMM Channel 1 East (Police) (Lombard, Villa Park)
 470.4375 Illinois State Police Emergency Radio Network (ISPERN)
 UHF Patch
 470.5125 DU-COMM Police (Darien, Lisle, Woodridge)
 470.6625 Downers Grove Police (Tactical) (for Downers Grove, Lisle, and Darien)
 470.6875 DU-COMM Channel 1 West (Police) (Bartlett, Carol Stream, Hanover Park)
 470.7250 Wheaton Park District 5
 470.8875 DU-COMM Channel 3 East (Police) (Elmhurst, Oakbrook Terrace)
 470.9125 Downers Grove Police (Dispatch)
 471.0125 DU-COMM Channel 5 (Police) (Areawide)
 471.0375 Elmhurst Police (Alternate)
 471.0750 Winfield Emergency Management
 471.1375 DU-COMM Channel 3 (Police) (Glen Ellyn, Wheaton)
 471.1875 Shared Police (Itasca, Roselle)
 471.2125 Police (Bensenville, Wood Dale)
 471.2500 County Government Buildings (Security Operations)
 472.1250 Willowbrook Police
 472.6000 SWCD Police Automatic Vehicle Locators (Telemetry)
 472.6250 SWCD Police Dispatch (Burr Ridge, Clarendon Hills, Hinsdale, Willowbrook)
 472.8125 Oakbrook Terrace Police (Alternate)
 472.8875 Downers Grove Police (Alternate)
 473.7250 Wheaton Park District 6
 475.1250 Willowbrook Police (Tactical)
 476.4125 DU-COMM Channel 9 (Police) (Areawide)
 476.7125 Lombard Police (Tactical)
 476.7375 SWCD Police Dispatch (Burr Ridge, Clarendon Hills, Hinsdale, Willowbrook)
 477.6000 Roselle Police (Tactical)
 478.7625 Wheaton Park District 7
 854.9625 County Sheriff (Alternate)
 856.2125 County Sheriff (Courts)
 856.4625 Woodridge Police Channel 1 (Dispatch via DU-COMM South)
 857.3625 County Sheriff (Dispatch)
 857.4625 Woodridge Police Channel 2 (Alternate)
 857.9875 DU Police Mobile Data Terminals (MDTs)
 858.2125 Police Dispatch (Bloomingdale, Glendale Heights)

WWW.SCANCAT.COM

TOLL FREE 888-722-6228

ScanCat-Lite-PLUS

Reg. \$39.95 - Limited Time Special \$29.95

Now It's Easier Than Ever To Program Your Scanner.

FREE walk-you-through set up video. NEW! Home Patrol Video Tutorials!

www.scancat.com **You Tube**
 Click on "Learn as you view."

Open Up Uniden HomePatrol's True Potential

NOW! (now supports latest firmware upgrades)

Program ANY Frequency Into The HomePatrol Without Limitations (CB-Ham-Marine-GMRS-FRS)

COMBO ALL-IN-ONE CD

ScanCat-Lite-Plus.....\$29.95
 Mr. Scanner FCC Public Safety29.95
 Nat-Com's FCC Scancat Files9.95
 Bonus Disk Of Frequencies.....15.00
 If Purchased Separately \$84.85

NOW \$49.95

Plus \$6 s&h

PLUS FREE Scanning Magazine(s)
 (With Any Order Over \$40.00)

NOW AVAILABLE \$CALL HOKA Code 3-32



COMPUTER AIDED TECHNOLOGIES

ORDERS: (318) 687-4444 FAX: (318) 686-0449
Info/Tech Support: (318) 687-2555
 (9 a.m. - 3 p.m. Central M-F)

WWW.SCANCAT.COM

GRE PSR-500

- Frequency Coverage 25.000-1300.000 MHz (less cellular)
- Menu Driven Programming with Context Sensitive Help
- Flexible Free-Form Memory Organization
- GRE's Exclusive V-Scanner Technology
- Multi-System Trunking
- P25 NAC Functionality
- Exclusive ALERT LED
- Spectrum Sweeper
- Real-time Signal Strength Indicator
- SAME and All Hazards Weather Alerting and SKYWARN

Order SCN18

\$399^{95*}

* plus \$13.95 UPS Ground shipping in the U.S.



GROVE

800-438-8155
 828-837-9200 fax: 828-837-2216
 order@grove-ent.com
 7540 Highway 64 West
 Brasstown, NC 28902

www.grove-ent.com

858.2625 SWCD Police Mobile Data Terminals (MDTs)
 859.4875 DU Police Mobile Data Terminals (MDTs)
 859.7875 County Sheriff (Jail)

462.2875 Downers Grove Water
 467.2875 Downers Grove Water
 458.0875 Downers Grove Lightning
 956.25625 Lombard Water
 956.31875 Villa Park Water

❖ Forest Preserve District

The Forest Preserve District of DuPage County manages more than 25,000 acres of land, which makes up about 12 percent of all the land in the county. The District has its own Office of Law Enforcement with sworn officers who enforce laws and local ordinances. The Forest Preserve Police use StarCom21 talkgroups 1451 and 1452 but may also be heard on the following conventional analog frequencies:

Frequency	Description
151.250	Mobile Coverage Extenders
151.325	Operations
159.420	Special Events

❖ DuPage Airport

The DuPage Airport, FAA Identifier KDPA, is located in West Chicago and operates on the following frequencies. Remember that the aircraft radios operate using Amplitude Modulation (AM) rather than the more familiar Frequency Modulation (FM).

Frequency	Description
119.750	Clearance Delivery
120.900	Tower
121.800	Ground Control
122.950	Unicom
124.500	Tower
124.800	Automatic Terminal Information Service (ATIS)
133.500	Chicago Approach and Departure
257.800	Tower
453.500	Airport Authority Operations

Digital Telemetry

Municipalities within DuPage County also use frequencies in the Industrial and Business Band to provide water flow and lightning information. Automated meters transmit telemetry data to collection sites in order to provide county managers with environmental information from locations that would be difficult or time-consuming to measure manually.

Frequency	Location	Data Source
153.0125	Hinsdale	Water
159.7125	Woodridge	Water
160.1325	Elmhurst	Water
173.3125	Downers Grove	Water
173.39625	Glen Ellyn	Water
451.0375	Lombard	Water
451.1250	Wood Dale	Water
451.2125	West Chicago	Water
451.5125	Glen Ellyn	Water
451.6375	Glendale Heights	Water
451.6875	Glen Ellyn	Water
452.5250	Warrenville	Water
453.0875	County	Stormwater
453.2125	Westmont	Water
453.5625	County	Stormwater
453.6375	Roselle	Water
453.6625	County	Stormwater
453.7375	County	Stormwater
453.7625	Itasca	Water
453.8375	Addison	Water
456.3375	Oak Brook	Water
456.4375	Glen Ellyn	Water
456.6375	Glendale Heights	Water
457.3875	Glen Ellyn	Water
458.8375	Addison	Water
460.0125	Elmhurst	Lightning

❖ Los Angeles, California

Los Angeles County in southern California has 10 million residents and covers more than 4,000 square miles. There are 34,000 first responders from more than 80 public safety agencies on call to provide police, fire and medical services.

The Los Angeles Regional Interoperable Communications System (LA-RICS) was officially launched in 2009 with the goal of bringing these agencies and personnel onto a central, interoperable network that would allow them to communicate directly together for both routine operations and during emergency situations.

The LA-RICS network is envisioned to be a combined narrowband and broadband network operating in the 700 MHz band. The narrowband part of the network would provide voice and limited data services via APCO Project 25 standards. The broadband part would use LTE (Long Term Evolution) to give responders high-speed mobile data services, allowing them to do things like sending streaming live video, high resolution medical telemetry, and up-to-the-minute geographic information tied to a computer-aided dispatch system.

To provide all of these capabilities, the LA-RICS system would use almost 300 repeater sites, only 114 of which currently exist. 176 new sites would need to be built, along with the fiber and microwave backhaul links and related interconnections. The project has a budget of about \$700 million, with nearly \$300 million coming from Federal grants.

Like any large system overseen by a bureaucracy, there have been political shenanigans, back room deals, and lots of legal maneuvering. Early last year LA-RICS selected equipment vendor Raytheon to build the combined narrowband-broadband system. Motorola, a competitor in the bidding, persistently protested the award, citing a number of irregularities including the allegation that a member of the county's negotiating team gave Raytheon proprietary technical information from Motorola's private bid.

Last July, LA-RICS chose to rebid the entire contract after lawyers suggested that potential violations of state laws may have occurred regarding procurement and award of publicly funded projects.

Despite these setbacks, LA-RICS has gone on record stating that the new system could be operating by September 2013.

❖ Meriden, Connecticut

Meriden is a town of about 60,000 people located in New Haven County, Connecticut. It covers an area of about 24 square miles and lies along the banks of the Quinnipiac River. In 1939, Edwin Armstrong, a pioneer in early radio and the inventor of Frequency Modulation (FM), originated one of the first FM radio broadcasts from a 70-foot antenna mast on West Peak, which rises 700 feet above Meriden.

The Meriden Police Department recently completed a \$1.8 million upgrade to their radio

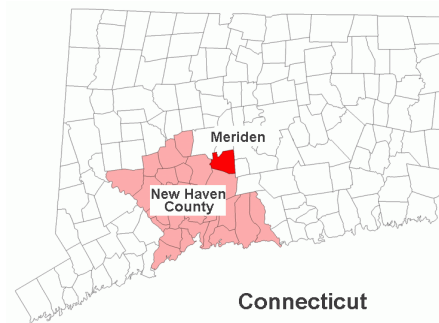

Connecticut

system, switching from analog to digital technology. The change itself wasn't particularly controversial, but the Chief also promised to encrypt all police transmissions at some point in the near future. Citing officer safety, his position is that encryption would prevent criminals from hearing police responses to crimes in progress. Unfortunately, encryption would also prevent citizens from being able to provide police with relevant and timely tips and will effectively shut out Neighborhood Watch groups from being alerted to local events and lookouts.

As a kind of consolation prize, the police department promised that a web site would be created that will show Internet-savvy visitors information from the police computer-aided dispatch system, listing locations and status of police calls. The information would be delayed 30 minutes, again for "officer safety."

The new system equipment was purchased from Tait and operates as two conventional (non-trunked) APCO Project 25 channels on the following frequencies:

Frequency	Description
852.4625	Meriden Police Channel 1
852.9625	Meriden Police Channel 2 (Dispatch)

Meriden is also licensed for three additional channels, specifically 851.9875, 852.4875 and 852.9875 MHz. The town plans to keep analog channels as backups in case they need to fall back and are identified as 855.5125, 852.7875, 854.2875 and 866.0125 MHz.

Other conventional analog frequencies for the area:

Frequency	Description
45.86	Police (across New Haven County)
46.380	Meriden Fire Dispatch
151.010	Meriden Highway Department
153.800	Connecticut Area 2 Emergency Management
153.890	Meriden Fireground
154.130	Meriden Fire Dispatch/Primary
154.295	Fire South Central Mutual Aid
453.175	New Haven County Interoperability (CMED)
453.325	Meriden EMS (Tactical)
453.600	Meriden Civil Preparedness Operations
460.150	Police (Countywide)
463.750	Meriden Emergency Medical Services (Dispatch)

That's all for this month. More information these and other topics are available on my web site at www.signalharbor.com. I welcome your questions, comments and frequency lists via electronic mail to danveeneman@monitoringtimes.com. Until next month, happy scanning!



Q. Some public safety services now use Internet dispatching. How does that work? (J.O.)

A. To overcome the radio incompatibility between adjacent but inter-dependent communities, as well as the delays in making phone calls, Voice Over Internet Protocol (VoIP) is being adopted. A good example of this is the Piedmont regional partnership involving the Caswell County Sheriff and the Highway patrol in North Carolina, and the Pittsylvania County Sheriff's Office and the State Police in Virginia.

To intercommunicate, the audio from the radio communications is fed into a computerized system which digitizes the audio and sends it via the Internet to participating agencies to be decoded back into normal analog sound and into the other agencies' radio systems.

Highway pursuits from one jurisdiction to another can be intercommunicated in normal two-way fashion.

Q. I'm reluctant to replace my standard light bulbs with newer compact fluorescent lights. Is there really a savings? After all, the newer bulbs cost considerably more.

A. Traditional tungsten-filament bulbs waste 90% of their electricity as heat; only 10% of the energy consumed is emitted usefully as light. The new CFLs use 75% less electricity to provide the same amount of light as traditional incandescent bulbs, and last ten times longer. The even newer LED bulbs use 85% less electricity for the same illumination, and last forty times longer.

Like all new technologies, the new bulbs are initially more expensive, but prices continue to drop. I suspect that even CFL bulbs will eventually give way to LED for the long term. LEDs respond instantly with full brilliance, produce no radio interference as some CFLs do, are much more durable, and contain no toxic substances like the solder in incandescents and the mercury in CFLs.

Q. How do U.S. AM radio stations continue to operate when Canada and Mexico are abandoning the medium wave band?

A. With economic unrest and political upheaval, talk radio is a current rage on AM in the U.S. As long as there is an audience, there will be sponsors, and as long as there are sponsors, there will be a profit.

Q. Back in the 1970s and '80s I use to listen to dozens of radio stations in the tropical band between 4700 and 5100 kHz, mostly Latin and South American stations. Now, I'm lucky if I can hear one or two. Have most of these stations simply gone off the air? (Robert Yajko, West Leechburg, PA)

A. Some have, indeed, gone off the air, replacing their old HF equipment with more modern, static-free, FM for their regional audience. It's just a sign of the times as less-technically-endowed countries follow trends in the modern world.

Q. I own three different handheld scanners. Recently I have been receiving a lot of squelch or static around 700 MHz and occasionally on other bands as well. What could be causing this? (Dudley, email)

A. If you are hearing the same thing on all three scanners, and you are hearing it on the hand-held scanners even away from your house, and the squelch noise pops on for a few seconds then off like it's a signal, and it's on a narrow part of the spectrum like a single channel, you are probably hearing the digital transmissions from a 700 MHz band trunking system.

Such digital systems are also used on other land-mobile frequencies as well, thus accounting for hearing the same sound on other bands.

Q. I have been reading the various articles in MT, discussing coax vs. window line, feeding a single antenna used over several bands. Because of that, I just replaced my coax with 450 ohm window line feeding a 40m dipole. I am using a Versa Tuner II. Everything seems good so far. Do you think this is a big improvement over coax? The idea is that window line will get more power to the antenna in high SWR instances. I run 80 through 15m with this

dipole. (Mark Morgan, N8QIK, Cincinnati, OH)

A. Losses in transmission line from high SWR depend upon the frequency, amount of mismatch, length of the line, and insulation characteristics. Open-wire "ladder line" is one of the least lossy cables, if not the least. But since it has no shielding, you have to be careful not to run it along metal surfaces. And it will pick up nearby electrical interference.

If you are getting a good conjugal impedance match with your VersaTuner II and aren't hearing radiated interference from electrical and electronic home appliances or your computer, it's an excellent choice.

Be sure to check the line periodically for age cracks which can hold dirt, salts, and moisture; if it shows these, replace it.

Q. Will there be a new digital standard for non-public safety and government radio, like railroads and business?

Why did AES replace the old DES encryption standard for government trunked systems? Is DES still used on some local/state trunked systems? (J.J. Owens, Fayetteville, NC)

A. I'm unaware of any plans to alter the current standards for other users of the spectrum. APCO P-25 is by far the major standard and it's working well. For encryption, the newer AES standard has proved to be a better performer than the old DES, and has virtually unbreakable code. Chances are that current users of DES at the local and state level will continue if they are not required to change for compatibility purposes.

Q. Do all cell phone systems use the same 800 MHz frequencies?

A. Not by a long shot. If we consider North American along with European/Asian allocations, currently used bands include 806-960, 1710-1785, 1805-1990, and 2110-2170 MHz in various fractional combinations among licensees and countries.

Questions or tips sent to Ask Bob, c/o MT are printed in this column as space permits. Mail your questions along with a self-addressed stamped envelope in care of MT, or e-mail to bobgrove@monitoringtimes.com. (Please include your name and address.)



The Beginner's Guide to Funny Noises

Nothing gets more questions to this column than, "What's this noise?"

Some of the weirder sounds will forever be unexplained, or attributed to unknown ionospheric anomalies. Other odd noises, though, are created by the operation of some rather interesting devices using the shortwave band, also known as high frequency (HF). They can be annoying, but they are legal and useful to someone somewhere. Let's look at some of the most common ones.

❖ CODAR

CODAR stands for Coastal Ocean Dynamics Applications Radar. This is an HF sea surface radar that sweeps a pulsed carrier over a frequency range so wide that people can't help but notice it. In fact, it gets more questions than anything.



Most CODARs are made by the company with the same name. A lot of these are in use, especially along the US West Coast. There are several configurations for research, wave observation, or surveillance. They are most commonly encountered on frequencies between 4-5, 12-13, and 24-25 megahertz (MHz). Most use small, low-powered equipment, but a few larger ones in the low range can really get out at night.

The sound depends on where in the wide sweep the listener's radio is tuned. Usually, it's a "zwoop zwoop zwoop" kind of noise, crossing the passband once or twice per second. Nearer the edges, it can sound a bit like a time signal, though it doesn't sync with WWV. Technical details, and even transmitter locations, are all over the Internet.

❖ Chirpsounders

"Chirpsounder" is the name given to a type of ionospheric sounder first marketed by BR Communications, which merged with antenna maker TCI to become TCI/BR. They are still made. As we hear daily on the bands, a lot of them are in civilian and military use to keep track of the best propagation frequencies in real time. The sounder works by sweeping a continu-

ous carrier up HF, typically from around 2 to 30 MHz, at a rate of 100 kilohertz (kHz) per second. A remote receiver follows the sweep up the band and plots an "ionogram" from the changing propagation delays. An embedded order wire (Chirpcom) can send short text messages to the receiver by slightly shifting the carrier during the sweep.

The "chirp" refers to the short, distinctive sound made when it sweeps across a frequency. This chirp lasts a fraction of a second, and can be rather jarring when the audio gain is cranked on a very weak signal.

Some sounding start time schedules are available to the public, though most aren't. This suggests one means of identifying at least some of the transmitters, by noting exactly when they chirp a specific frequency.

❖ Over-the-Horizon Radar

HF over-the-horizon radar is also known as backscatter radar, from the mode of propagation used to receive the returned echoes. This allows surveillance at a greater distance and lower altitude than the line-of-sight range of microwave radar systems.

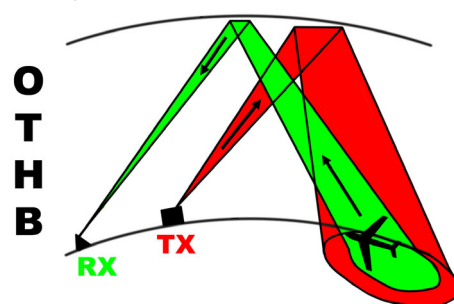

Backscatter radars were first used for Cold War early warning systems. These used extremely high peak power, and some had truly majestic antenna arrays putting miles of steel in the sky.

Most newer setups are easier to live with, though they are in more widespread use. Some are much smaller. The US Navy has a relocatable system that can be moved as needed. All these are typically used to detect cruise missiles, low-flying aircraft, or fast boats that might be up to no good.

The exact frequencies used vary with real-time soundings, and go higher in day time. An unusually high frequency can suggest very good band conditions. A rapid chirp typically sweeps a range of 10 to 40 kHz, at a rate from 10 to 60 times a second. Ordinary receivers hear this as

a pulsed, blating, buzz type of sound. It's been likened to a certain rude audio emission from the human posterior. Some radars transmit brief audio tones first to warn other HF users or to reduce the gain of wide-open circuits. Most, however, just blast.

❖ Equipment Malfunctions

The world's militaries and their civilian contractors have deployed a lot of complex gear all over the planet. It doesn't always do what its designers intended, and some faults are too intermittent to be duplicated during normal troubleshooting.

Two resulting funny noises have been referred to as "backward music" and "whales." Both tend to appear on or near military frequencies. Both names are descriptive, but often they are incorrectly exchanged.

Technically, "backward music" is a rising single tone. Both audio sidebands often appear, moving in opposite directions. The result really does suggest a type of analog electronic music popular in the psychedelic 1960s.

"Whales," meanwhile, are a richer, more vocal, multi-tone sound. It really does produce haunting moans that can resemble whale vocalizations.

Both of these are malfunctions, though the precise mechanism will apparently be argued forever. Some have suggested various types of radio-frequency (RF) feedback. Others think it's signal hunting by noisy open circuits with heavy line conditioning. Perhaps both are responsible, in different cases.

❖ The HFGCS Phaser

Reports persist of a space-gun noise on 8992.0 and 11175.0 kHz, both primary frequencies in the US Air Force High Frequency Global Communications System (HFGCS). It is invariably described as sounding like those phaser weapons that Captain Kirk and Mister Spock used against all manner of enemies in *Star Trek*.

The problem is that HFGCS supports several data communication modes, so it might or might not be one of those. It's apparently never heard out here in the western US, and searches turn up no recordings. Anyone who has recorded the phaser is encouraged to e-mail it to this column, so it can be identified.

❖ Eight Niner Eight Niner

Moving along from funny noises to real communication, let's talk about 8989.0 kHz. It's

a USB frequency in the off-route (OR) portion of the Aeronautical Mobile service. OR segments are used by flights with no set routes or schedules, usually military in nature.

“Eight Niner Eight Niner,” as pilots call it, was at one time a good place to snag some great US military catches. Old logs show many Air Force missions, some Navy ships working Air Force stations, and even tactical use by the US Coast Guard.

All the US Air Force action is now on the adjacent 8992 kHz HFGCS. 8989 is still used by the Belgian Air Force station ONY, at Melsbroek, for ground-to-air comm. There are probably a few other militaries here as well.

After that, it gets strange. Around 2008, the Saudi Arabian Saudia Airlines established a company Long-Distance Operational Control (LDOC) frequency here. LDOC is a legitimate use of the aero bands, but they really should be in the routed segments. In any event, “Jeddah” is regularly reported, working Saudia flights in English and Arabic.

More recently, listeners have reported Spanish on the frequency. It might be more than one station. Some people have claimed to have heard another LDOC, though nothing can be confirmed.

What can be confirmed is a Nicaraguan USB voice station working fishing boats nearly every day. This one’s audible in Europe as well in the US. It’s on in the evenings (local time), usually for a couple of hours starting at 2200 or 2300 UTC. There are various sorts of traffic, but most of it consists of religious messages.

Right now, at 2230 UTC, a real old-style preacher is weakly readable in Spanish here in California. He’s burning up the ionosphere with that distinctive cadence peculiar to good radio sermons. Music has also been heard.

It seems likely that all this is part of a religious outreach to a Nicaraguan fishing group from the Mosquito Coast in the country’s northeast. Note that “Mosquito” refers here to the indigenous Miskito peoples that inhabit the area, not the flying insect. Many men of this culture derive some or all of their income from fishing in the Caribbean. Most of these are Christians, and they spend long periods away from home.

Other, more sporadic, operations have been reported in various other languages. Maybe “8989” is just easy to remember. It’s certainly easy to type. The fun continues daily.

Enjoy these good band conditions, and see you next month.

ABBREVIATIONS USED IN THIS COLUMN

AFB.....	Air Force Base	LDOC.....	Long-Distance Operational Control
ALE.....	Automatic Link Establishment	MARS.....	US Military Auxiliary Radio System
AM.....	Amplitude Modulation	Meteo.....	Meteorological (weather office), also “Metro”
AWACS.....	Airborne Warning And Control System	MFA.....	Ministry of Foreign Affairs
CAMSLANT.....	Communications Area Master Station, Atlantic	NAT.....	North Atlantic air route control, families A-F
CAMSPAC.....	Communications Area Master Station, Pacific	Pactor.....	Packet Teleprinting Over Radio, modes I-IV
CAP.....	US Civil Air Patrol	RTTY.....	Radio Teletype
COTHEN.....	US Customs Over-The-Horizon Enforcement Network	S21.....	Russian voice, monthly on seasonal 2-frequency pairs
CW.....	On-off keyed “Continuous Wave” Morse telegraphy	S28.....	Russian military “Buzzer” (UVB76, MDZhB, etc).
DSC.....	Digital Selective Calling	Selcal.....	Selective Calling
E11.....	“Strich” family numbers, says “Oblique” for “/”	SESEF.....	Shipboard Electronics Systems Evaluation Facility
E11a.....	E11 variant, ends “Out”	Sitor.....	Simplex Telex Over Radio, modes A & B
FAX.....	Radiofacsimile	UK.....	United Kingdom
FEMA.....	US Federal Emergency Management Agency	Unid.....	Unidentified
FM.....	Frequency Modulation	US.....	United States
G11.....	German version of E11, says “Strich” for “/”	USAF.....	US Air Force
HFDL.....	High-Frequency Data Link	USCG.....	US Coast Guard
HF-GCS.....	High Frequency Global Communications System	USS.....	United States Ship
HMS.....	Her Majesty’s Ship	Volmet.....	“Flying Weather;” airport observations & forecasts

All transmissions are USB (upper sideband) unless otherwise indicated. All frequencies are in kHz (kilohertz) and all times are UTC (Coordinated Universal Time). “Numbers” stations have their ENIGMA (European Numbers Information Gathering and Monitoring Association) designators in ().

147.3	DDH47-Deutsche Wetterdienst, Pinneberg, RTTY weather forecast in German, at 1058 (MPJ-UK).	5000.0	IBF-Italian time signals, Torino, special “memorial” broadcast with announcements in Italian, French, and English on 20th anniversary of original station’s closing, at 0314 (PPA-Netherlands).
501.35	IQ2MI-Italian 600-meter experimental station, Milan, CW beacon at 0330 (ALF-Germany).	5066.5	USADA1010-US Army, ALE text message for USAIS1012, at 2211 (Bob Wilczynski-MA).
1888.0	IPD-Civitavecchia Radio, Italy, weather in English and Italian at 1946 (PPA-Netherlands).	5082.0	Unid-English “Oblique” station (E11), null-message callup “416/00,” at 1730 (Boender-Netherlands).
2640.5	CLBRT13GNET-Unknown net, calling BOG3NET and POG3NET, also on 2828, 3224.5, and 4768.5; ALE at 2212 (Jack Metcalfe-KY).	5206.0	KA-English Channel navy exercises, control with KC and KE, at 0842 (Lacroix-France).
2872.0	Gander-NAT-C, Newfoundland, Canada, clearing flight KLM 282 to new altitude, at 0503 (Allan Stern-FL).	5237.5	8B5760-Unknown, possible US military, ALE sounding at 2229 (Wilczynski-MA).
2899.0	Gander, selcal check with Continental 467, at 0544 (Stern-FL).	5260.0	9A0ST-Croatian Amateur Radio Emergency Operations Network, Split, ALE sounding with 9A5EX and 9A0OS, at 2146 (ALF-Germany).
3016.0	Shanwick-NAT-A, Ireland, working airliners at 0516 (Stern-FL).	5345.0	14B-UK Army Cadet Forces, contest exchanges with 14B, 20C, 33B, 54B, 76C, 80C, 82D, 94A, 97B, MRO44, MRO53, and N48A; starting at 1710 (ALF-Germany).
3228.5	Unid-Russian Air Defense, time-stamped CW tracking strings with “?” for missing items, also on 7913.5, at 1913 (PPA-Netherlands).	5347.9	PH37BBF-Unknown Netherlands propagation beacon, sending position in CW, at 2110 (MPJ-UK).
3323.0	The Russian Lady-Possibly Russian intelligence (S21), callup “323 (3x) 891 36,” then message in 36 5-figure groups, ending “891 36 000;” always parallel 3823; three days at 1842 (Ary Boender-Netherlands).	5350.0	I2JV-Russian Air Defense tracking, automated beacon with changing identifier and AR (end of message), at 0400 (ALF-Germany).
3413.0	Shannon Volmet, formatted aviation weather, also on 5505 and 8957, at 0438 (Stern-FL).	5399.5.0	AEM1US-US Army MARS; Baumholder, Germany, Pactor-I identifier after Pactor-III bulletin board traffic, at 1650 (ALF-Germany).
3455.0	New York-Caribbean oceanic air control net, position check with JetBlue 841, at 0555 (Stern-FL).	5450.0	Unid-UK Royal Air Force Volmet, European aviation weather at 0543 (Stern-FL).
3485.0	New York Volmet, NY, aviation weather, also on 6604, 10051, and 13270; at 0441. Gander Volmet, Canada, aviation weather at 0540 (Stern-FL).	5547.0	San Francisco-Central/ East Pacific air control, position check with flight American 102, gave them 6673 secondary, at 0902 (Stern-FL).
3850.0	BP21-German Bundespolizei (Federal Police) patrol boat 21 (Bredstedt, DLGZ), ALE linking to control at Cuxhaven, then simplex modem traffic, at 2351 (MPJ-UK).	5550.0	New York-Caribbean air control, selcal DS-MR for Reach 311, a USAF Air Mobility Command C-5, at 0624 (Stern-FL).
4440.0	N70A-UK Army Cadet Forces/Combined Cadet Forces, contest exchanges with 31A, MRO53, 99B, 79A, and 53B on channel VY, at 0200 (ALF-Germany).	5598.0	New York-NAT-A, working airliners at 0213 (Stern-FL).
4550.0	MRA53-UK Army Cadet Forces net control, contest exchanges with 20C, 31A, 54B, 76A, 99B, MRF31A, and MRF76A; at 0700 (PPA-Netherlands).	5616.0	Gander-NAT-C, working various flights, handed one to Shanwick on 2899, at 0549 (Stern-FL).
4618.0	BP25-German Bundespolizei patrol boat 25 (Bayreuth, DBGY), working Cuxhaven in ALE, at 2354 (MPJ-UK).	5649.0	Gander-NAT-C. selcal DJ-RS for Iberian 6252, an A340 reg EC-GGS, moved to 6622 (NAT-F), at 0524 (Stern-FL).
4675.0	Shanwick-NAT-D, working flight Air France 377, at 0652 (Stern-FL).	5696.0	CAMSLANT Chesapeake-USCG, VA, taking ops-normal from HC-130J Coast Guard Rescue 2002, at 0445 (Stern-FL) Coast Guard 1703-USCG HC-130H, radio check with CAMSPAC Point Reyes, CA, at 1703 (Dean-CA).
4755.0	Alenki-Yekaterinburg Aero, Russia, radio checks in Russian with Tvarets (Penza Aero), Brashka (Chelyabinsk Aero), Katiusha (Novosibirsk Aero), Makhavik (Kurgan Aero), and Amba (Samara Aero), at 0102 (ALF-Germany).	5720.0	TC-JNF-Turkish Airlines flight TK0709, an A330, HFDL log-on with Reykjavik, at 2356 (MPJ-UK).

5732.0 LNT-USCG CAMSLANT, VA, calling N09, probable USCG HC-144A patrol aircraft on COTHEN, at 0426 (PPA-Netherlands).

5881.5 R24442-US National Guard helo, working KBDLNG, National Guard at Bradley International Airport, CT, ALE at 1544 and 1806 (Wilczynski-MA).

5895.0 Squalo 121-Italian Financial Police Patrol Boat Urso (G-121), working Sirio 10, at 1135 (ALF-Germany).

6229.5 Delta-Italian Navy, tracking exercise ("Alligator Playground") data with Mike Delta, at 0522 (ALF-Germany).

6297.7 ZH-Brazil Navy vessel, Sitor-B simplex course/speed and operator chatter with vessel XB, at 0530 (ALF-Germany).

6340.5 NMF-USCG, Boston, MA (remote to CAMSLANT), FAX upper-level chart at 0432 (PPA-Netherlands).

6379.0 4XZ-Israel Navy, Haifa, CW marker and several messages for CG5C, at 0145 (ALF-Germany).

6433.0 Unid-German "Strich" station (G11), null-message callup "270/00," at 1750 (Mike-West Sussex, UK).

6487.0 Y59-Israeli Air Force aircraft, 2-way ALE link check with AAA (Lod Air Base), at 1646. TSM, ALE link check with C30, at 1900 (ALF-Germany).

6535.0 Dakar-AFI-1, Senegal, working airliners at 0102, 0425, and 0643 (Stern-FL).

6586.0 New York-Caribbean air control, setting up with USCG HC-130H Coast Guard Rescue 1716, at 0523 (Stern-FL).

6617.0 Rostov Volmet, aviation weather in Russian for Krasnodar, at 0426 (PPA-Netherlands).

6622.0 Gander-NAT-F, selcal check DJ-RS with Iberian 6252, who came from 5649, at 0527 (Stern-FL).

6628.0 New York-NAT-E, giving secondary frequency 2962 to an unknown aircraft at 0224 (Stern-FL).

6640.0 New York, patch to Medlink from JetBlue 838, an A320 reg N516JB, regarding a sick passenger, at 2245 (Stern-FL).

6649.0 Atlantico-South American air control, Recife, Brazil, working AeroMexico 001, at 0529 (Stern-FL).

6661.0 "04"-HFDL ground station, Riverhead, NY, uplinks to N967CG (Avianca A330), and XA-ING (ABC Aerolinesas), at 03131. Mumbai-India regional air route control, selcal DK-EL to Air India Express flight AXB540, a B737 reg VT-AYD, at 2058 (PPA-Netherlands).

6673.0 San Francisco-Central/East Pacific air control, CA, working airliners at 0237 (Stern-FL).

6754.0 Trenton-Canadian Forces Volmet, Trenton, Ontario, also on 15034, aviation weather at 0547 (Stern-FL).

6797.0 K22-Israel Air Force KC-130H number 522, reg 4X-FBY, ALE link check and phone patch in Hebrew with AAA (Lod Air Base), at 0133 (ALF-Germany).

6890.0 SHLIST-State of Schleswig-Holstein Water Protection Police, List, Island of Sylt, Germany, ALE and voice with SHKIEL (State Headquarters, Kiel), at 1040 (ALF-Germany).

6985.0 MAAASF1-US Army Aviation Support Facility #1, MA, working aircraft R23593, ALE at 2302 (Metcalfe-KY).

7308.0 State RACES 1-IL Radio Amateur Civil Emergency Service [Rhymes with "Macy's" - Hugh], in large exercise with Illinois Emergency Management Agency (IEMA) Regions 8, 9, and 11, at 1644 (Metcalfe-KY).

7361.5 R00212-US Army National Guard, working B5Z159, ALE at 1939 (Wilczynski-MA).

7535.0 Determined Warrior-US Navy vessel USS Cole (DDG-67), testing various modes with Norfolk SESEF, VA, at 1450 (Metcalfe-KY).

8190.0 CAVATORTO-Italian Financial Police high speed boat (G-124), ALE and voice with LAMPEDUSA, at 0826 (Lacroix-France).

8414.5 319545000-Cayman flag chemical tanker Stolt Surf (ZCSR3), DSC to Rescue Coordination Centre Australia, at 0651. 240511000-Greek flag container ship Cosco Hellas (SWJG), DSC to 239591000, Greek flag tanker Astrea (SVOZ), at 0926 (Patrice Privat-France).

8502.0 NMG-USCG, New Orleans, LA, simulcast of CAMSLANT Chesapeake "Iron Mike" voice weather forecasts, at 2330 (Robbie Spain-WY).

8825.0 New York-NAT-E, selcal EQ-BC and position with Delta 217, a B757 reg N704X, at 0617 (Stern-FL).

8829.0 Turkish Airlines 652-A330 reg TC-JNL, selcal check AF-BS with Ankara company LDOC, at 1802 (PPA-Netherlands).

8891.0 Unknown-NAT-D, selcals and polar air traffic control, at 2344 (Spain-WY).

8918.0 New York-Caribbean air control, position check with HC-130H Coast Guard Rescue 1711, enroute to a search, at 2240 (Stern-FL).

8933.0 New York LDOC, working Giant 5437, an Atlas Air freighter, sent aircraft to 6640, at 1203 (Stern-FL).

8942.0 "07"-HFDL ground station, Shannon, Ireland, working many airplanes at 1430 (MPJ-UK).

8971.0 Fiddle-US Navy, FL, going green (secure) with P3-C Red Talon 711, at 2135 (Stern-FL).

8989.0 Saudia Operations-Company LDOC, Jeddah, Saudi Arabia, selcal check CF-DH with B747 HZ-AIP, at 1808 (PPA-Netherlands). Unid-Central American religious net, Spanish religion and fishing boat traffic, at 2256 (ALF-Germany).

8992.0 Torch 50-USAF test flight, passing a "short title" group to McClellan HF-GCS (McClellan AFB, CA), who went off to look it up, then came back calling Landfall, answered by Torch 50, at 1847 (Hugh Stegman-CA).

9079.0 E11a, English version of some null-message callup "270/00" as G11, ended "Out," at 0930 (Boender-Netherlands).

10150.0 Headmaster-US military, relaying a long message from Granite Sentry to Looking Glass, at 2101 (Metcalfe-KY).

10680.0 Unid-US Military, radio checks with HQ6, HQ7, and HQ42, at 1855 (Metcalfe-KY).

11090.0 KVM70-US government, Honolulu, HI, FAX satellite image at 1838 (PPA-Netherlands).

11175.0 Puerto Rico-USAF HF-GCS, Salinas, patching Yankee 97, a US Marine Corps KC-130T, to Andrews base ops regarding diversion for mechanical problem, at 1613 (Stern-FL).

11232.0 Dragnet Uniform-USAF E-3B AWACS, patch via Trenton Military (Canadian Forces, Ontario), passing line-formatted traffic to Tinker AFB, OK, at 1545 (Stern-FL).

11306.0 "16"-HFDL ground station, Agana, Guam, uplink to Air Philippines flight 2P0793, at 1645 (PPA-Netherlands).

11330.0 New York-Caribbean air control, working P-3C Navy LK 01, at 1919 (Stern-FL).

11342.0 New York LDOC, weather for Israeli Air Force flight IAF 207, at 1456 (Stern-FL).

11345.0 Condor 184-Condor Flugdienst, calling Stockholm LDOC with no joy, at 2112 (Stern-FL).

11396.0 New York-Caribbean air control, position from Martinair 7003, at 2046 (Stern-FL).

11426.5 KEC 322-US Environmental Protection Agency, RI, working KTQ 319, EPA, CA, then went to 17487, at 2004 (Metcalfe-KY).

12168.0 E3BM-Virginia Defense Force (National Guard), Manassas, calling VDFALE, ALE at 1623 (Metcalfe-KY).

12290.0 CAMSLANT Chesapeake-USCG, calling vessel Azteca, a Mexican flag dive vessel (XCKJ9) on underwater ops, at 1628 (Metcalfe-KY).

12577.0 477770500-Hong Kong tugboat Huizhi (VRGU2) working in Shenzhen Harbor, DSC call at 2143 (Privat-France).

12750.0 NMF-USCG, Boston, MA, FAX test pattern at 1408 (Lacroix-France).

13146.0 ZSC-Capetown Radio, South Africa, female voice weather at 1832 (PPA-Netherlands).

13176.0 KKL-Republic Radio, Vashon Island, WA, CW identifier every 3 minutes in Pactor-I burst marker, at 1537 (PPA-Netherlands).

13257.0 Trenton-Canadian Forces, ONT, selcal check FM-DG with Canforce 85, a CC-130E number 130327, at 1707 (Stern-FL).

13270.0 "06"-HFDL ground station, Hat Yai, Thailand, working PK-GFK, a Garuda Indonesia B737, at 1821 (PPA-Netherlands).

13282.0 VRK22-Hong Kong Volmet, China, aviation weather at 1546 (PPA-Netherlands).

13306.0 New York-NAT-A, clearing higher altitude for Arkefly 343, a B767 reg PH-AHQ, at 1859 (PPA-Netherlands).

13351.0 "05"-HFDL ground station, Auckland, New Zealand, working China Eastern Airlines flight CES273, at 1324 (PPA-Netherlands).

13927.0 AFA3CU-USAF MARS, VA, patching B-52H Chill 11 to Minot AFB Bomber Ops, ND, regarding Chill 14 and 15, at 2019 (Stern-FL).

14484.0 Top Hand-US Military, working Looking Glass at 1821. Step Mother, copying message from AAN4MEM (likely Army MARS), also at 1821 (Metcalfe-KY). [Some sort of recurring exercise. -Hugh]

16804.5 234606000-UK Royal Navy frigate HMS Kent (GDJR), DSC call to 234621000, frigate HMS Northumberland, (GCOH), at 1346 (Privat-France).

17912.0 "14"-HFDL ground station, Krasnoyarsk, Russia, uplinking weather for Anchorage, AK, to N671US, a Delta Air Lines B747, at 1042 (PPA-Netherlands).

18500.0 The Buzzer-Russian military (S28), fourth harmonic of 4625, usual buzzy marker for short voice broadcasts, AM at 0553 (Boender-Netherlands).

18560.0 BMF-Taiwan meteo, FAX satellite image at 1321 (PPA-Netherlands).

18594.0 LNT-USCG CAMSLANT, VA, calling J42, USCG MH-60 helicopter number 6042, COTHEN ALE at 1633 (MPJ-UK).

19770.0 XSQ-Guangzhou Radio, China, phone patch in Chinese, at 1014 (PPA-Netherlands).

19794.0 XSQ, patch to Asian music on hold, then phone call in Chinese, at 1256 (PPA-Netherlands).

20186.0 HK11-Finnish MFA, Helsinki, working RIA, probably Riyadh embassy in Saudi Arabia, at 1124 (MPJ-UK).

20890.0 LNT-CAMSLANT, calling 002, USCG HC-130J number 2002, COTHEN ALE at 1637 (MPJ-UK).

21866.0 FCSFEM2-FEMA, probably Mt. Weather Emergency Assistance Center, VA, working FR7FEM, FEMA Region 7, at 1638 (MPJ-UK).

24526.0 FCSFEM2-FEMA, probably Mt. Weather, VA, calling FM4FEM, probably Region 4 MERS (Mobile Emergency Response Support), GA, at 1549. FCSFEM2, working FCOFEM, FEMA Region 10 Communications, at 1745 (MPJ-UK).

25120.0 C2-Moroccan government/military, working S3, ALE at 1640 (MPJ-UK).

25395.0 Unid-Russian taxi company, female working mobiles in Russian, many other frequencies also in use, at 1318 (PPA-Netherlands).

27870.0 PLASPR-USAF Secure Internet Protocol Routed Network gateway, Lajes, Azores, ALE sounding at 1120 (MPJ-UK).

30100.0 53-US military, tactical (training?) comms with 5, 55 Alpha, and others, FM at 1427 (ALF-Germany).

30220.0 XKCO414-Canadian hospital paging, North York, Ontario, FM identified in CW tones every 30 minutes, similar FM paging on 30420, at 1338 & 1408 (ALF-Germany).

30740.0 WNUB 566-Bell Car Service, Brooklyn, NY, dispatch in Spanish and English; similar on 31240, 31440, 31720, and 33160; FM at 1450 (ALF-Germany).

33420.0 WQIN 663-Orlando, FL Office of Emergency Management, rebroadcasting weather warnings from apparent AM travelers' information station, FM at 1345 (ALF-Germany).



Spotlight on Morocco

This North African country of some 32 million people has some interesting HF digital networks that can be widely heard across the globe.

❖ Moroccan Army Network

The Moroccan Army comprises nearly 175,000 regular troops and 150,000 reservists and is organized into two zones: the Northern Command (HQ in Rabat) and the Southern Command (HQ in Agadir). The Northern Command has been largely deployed to patrol Morocco's extensive border with Algeria, and the Southern Command has been engaged in a long-standing guerrilla war with the Polisario in the disputed territory of Western Sahara.

The most common way to hear the Moroccan Army is through a rather extensive ALE-managed network that has been active since the early 2000s and which can be heard on the following channels: 3840, 4970, 5258, 5430, 5755, 5855, 6552, 6562, 6770, 7639, 7650, 7740, 7786, 7813, 7830, 8046, 8096, 8164, 8875, 8894, 9212, 9220, 10185, 11111, 11130, 12140, 12160, 13432, 13850, 14550, 14585, 17137, 18100, 20550, 21145, 25120, 28805 kHz USB

At the time of writing here on the northeastern seaboard of the US, the most active daytime channels are 14550 and 25120 kHz, dropping to 11130 kHz during the late afternoon and evening and 8875 kHz at night.

Type 1
A2
B3, 5, 8
C2, 3, 4
D3, 5
E4, 6, 7, 45, 73
F3, 4, 301
G2, 3, 4, 5, 6, 22, 24, 42, 52, 61, 201, 301, 501
H1, 4, 601
I2, 5, 20, 201, 301
J5, 51, 53, 61, 62, 63, 64
K3
L6
M3
N4, 24
O2, 5, 6, 7, 8, 50, 71, 72, 73, 74, 81, 501, 801
P2, 5, 6, 30, 51, 52, 53, 301
Q2, 3, 4, 201
R3, 6, 8, 31, 32, 33, 301
S3, 31, 32, 33, 41, 42, 44, 60, 301, 401
T4, 401
U5, 6, 50, 501, 601
V5
W3
X2, 3, 5, 24, 26, 34, 201
Y1, 2, 10, 101
Z2

Type 2
072 (probably mis-configured 072)
A201ALE1
A2ALE3
A4ALE4
B301, B301ALE1
BF2
C3ALE2, C3ALE3, C3ALE4
CD
CM4
COWAWA2ALE
COWEST2ALE
D3ALE4
E401ALE1
F301
FG3, 301
G6ALE1
GLOBAL
GS4, 401, 52
GUERCIFALE4
H4ALE4
IR4, 5, 401
J5ALE2
L6ALE4
L601ALE1
LA5
LG6, 601, 602
LG6ALE1, 3
KA2
KB3
N4ALE2
N401ALE1
NET1
O5ALE3
O6ALE1
O8ALE1
P3ALE1, 3
P5ALE1
FPC
Q2ALE1
Q201ALE1
R301ALE1
S3ALE3
S301ALE1
S401ALE1
SG4
T401ALE1
T501ALE1
TIE
X2ALE3
X201ALE1
Y1ALE1, 2
Z2ALE1, 3
ZS1

During the early phase of the deployment of this network, place-name based ALE identifiers were used like KENITRAALE1, GUELMI-MALE2, etc. Later, the identifiers changed to an alphanumeric system where, strangely, only GUERCIFALE remains as the sole location-based ID.

There appear to be two distinct sets of identifiers as you can see below. The first uses a single letter A through Z followed by 1, 2 or 3 digits. The second uses longer alpha strings, often with the suffix ALE1, 2, 3 or 4. Both systems appear to be based around a three level hierarchy, probably reflecting a combination of the zonal organization of the Army and the usual brigade and battalion structure. The first type of ID does seem to be far more active than the second type, perhaps indicating that the latter is the reserve forces and the former is the regular army. The Type 1 and Type 2 sidebars list the identifiers that can be regularly heard:

Like most large ALE networks, most of the activity comprises link quality assessments between the stations, and it's also clear from listening to particular stations that the same transmitter often shares more than one identifier. The most active station is "C3", who has also been seen masquerading as "U5" on occasions and is probably the (or one of the) net control stations. Most stations seem to interact freely with others in the network. Voice chatter using Codan radios has been frequently heard both in the clear (with the characteristic +1200Hz piptone) and often switches to Codan's NGT voice scrambler for more private conversations.

There is also data using MIL-188-110A serial tone HF modem which is sent using 8bit synchronous mode with LSB (lowest significant bit) coding. Messages have the "*****" lead-in that is characteristic of Harris gateway equipment. To date, I have only seen this kind of activity between the stations "ZS1" and "GS52".

Aside from this large ALE network, it's possible to hear other Army units using conventional radios and data traffic using the MIL-188-110A 39 tone HF modem. This traffic is usually comprised of figure group off line encoded encryption and is sent using 75bps with long interleaving and ITA2 coding. Voice coordination is frequent with two-letter callsigns used by the two parties and a proprietary selcal often used for the call-up.

Here are the frequencies on which regular voice and 39 tone modem traffic has been heard: 5817, 8193, 8258L, 8270, 8297L, 12567L, 13415, 16764, 16793.5, 17036, 18193, 20250L, 20250, 22359L, 23827 kHz (L = LSB used)

❖ Moroccan DGSN

This Codan-based network was covered extensively in the June 2011 edition of this column. If you missed it, here are the frequencies and identifiers again.

Frequencies: 3155, 3805, 3830, 4040, 4460, 4855, 5083, 5140, 5321, 5435, 5792, 5820, 5823, 6500, 6792, 8600, 9200, 10390, 12065, 13490, 13499, 16240, 17435, 18765 kHz USB

Identifiers: 11xx, 13xx, 2011(Network Control Station, HQ, Rabat), 22xx, 24xx, 25xx, 11xxx, 13xxx, 20xxx, 22xxx, 24xxx

❖ Moroccan Diplomatic Service

Last heard in 1999, MFA Rabat used 50bd RTTY with 5 figure group offline encryption. Tactical callsigns like "F90" were used. Frequencies used were as follows: 11433, 14403, 18303, 18896, 18897, 20378, 20378.7, 20379.5 kHz.

❖ Update on Mystery PacTOR Networks

The daily transmissions on 19228.2 kHz using PacTOR-II appear to have moved to 19348.2 kHz during late November or at least have been replaced with this new channel. Unlike the previously daily changing tactical callsigns, this channel remains MU3UA and AL2LH. The same AirMail bulletin board software is used, though the announcement that users receive on connecting is, "Welcome to KTK Airmail box." KTK is frequently used as an abbreviation for the Indian state of Karnataka, so perhaps this is yet another small piece of evidence that continues to point that area of the world as the origin for this network.

A PacTOR-III network on 19241.5 kHz is currently very busy during most of the day. Just like the network above, I tend to hear one station much better than the other which is doing most of the sending. While I don't have PacTOR-III capability, I sent about 20 minutes of recording to a friend that does. The traffic was certainly email forwarding, but there was no conclusive information about the origin of the transmissions. It may be a new node for one of the numerous "email at sea" providers, but nothing has been seen on any of their websites about this frequency to date.

Lastly, here you can see a picture of the Sudanese Embassy in Sanaa, Yemen and the fine HF antenna installed on the roof. See the July 2011 edition for the full story. That's all for this month.





ON THE HAM BANDS

THE FUNDAMENTALS OF AMATEUR RADIO

Kirk A. Kleinschmidt, NT0Z

kirk@monitoringtimes.com

The Great Paper Chase!

This month's column was prompted by a quadruple-whammy convergence. I guess a bit of introspection as the new year approaches (not to mention the alleged end of the Mayan calendar!) will do that to just about anyone. By the time you read this, of course, 2012 will be well underway, and you will have probably already violated your New Year's Resolutions many times over. But as I write this on the eve of the 2011 ARRL 10-meter contest, Christmas is still a couple of weeks away (but the gift of propagation may come early).

This year's contest is expected to be special. The 2011 running is the first in many years that will likely see awesome propagation, just like "the good old days" when global DX on 28 MHz was the norm and not the rarest of exceptions. Because I need a few states and a few "entities" on 10 and 15 meters to finish Five-Band Worked All States, Five-Band DXCC and Worked All Zones (on any bands – please, please, please!), I'm hoping that the 10-meter contest will bring home the propagation so I can finally close out these awards that have been somewhat lingering for a decade or so.

I'm also in a bit of a video game phase (I was overdue), and I noticed something that's apparently now firmly a part of video game design practices: achievement awards (which are simply called achievements in various games). Video games have always kept track of how many dragons you've slain or how much gold you've accumulated, and these stats are still tracked. But many games now drive player advancement by offering in-game achievement awards that go above and beyond merely completing the game's main goals. Players can even view colorful plaques and certificates heralding their various achievements in special "wall displays." The similarity to amateur radio awards and certificates driving on-air activity on multiple bands and modes is striking!

The third whammy is the Kindle e-reader. I'm still learning about how to publish stuff on the Kindle and Nook e-book platforms, and I have been reading a book or two on the new entry-level Kindle, which retails for \$79 – a price

point that's going to further push the publishing world toward electronic books. The Kindle is undoubtedly nifty for readers and publishers, but e-books lack a certain tactile and nostalgic charm. Paper, it seems, is destined to become a rarity at some future point.

And that's not necessarily a good thing. If you think that looking at your own ham radio achievement awards on a smallish electronic display will produce anywhere near the pride and satisfaction you'll feel when looking at the same award, framed and on your wall in glorious, living color, I think you're mistaken! For certain things, paper is a necessity.

The fourth whammy relates to the above-mentioned New Year's Resolutions and the annual process we go through to set goals, make a little progress toward them, and then abandon them wholesale until we start the process over again next year. If you're a bit more successful (perhaps you've watched a critical mass of motivational speakers on late-night TV commercials), a better process might be: set a goal, achieve a goal, get a reward (or, in this case, an award!).

I'm talking this month about amateur radio operating awards, of course. There are hundreds of them to work toward, from traditional to obscure, and there are just as many good reasons to make them a part of your regular on-air pursuits. Millions of video gamers can't be wrong, can they?

Actually, it's the gamers who are taking a page from the ham operators on this topic, as we've had achievement awards for a hundred years or so. In addition to spurring us to get on the air and make contacts, operating awards can lead us to ever-new experiences as hams.

You might be well-versed at what happens on the low bands, for example, and may even already have a shiny Worked All States (WAS) award hanging on your shack wall. But now that the present solar cycle might actually be cooperating a bit, opening things up on 10 and 15 meters, adding a 10-meter endorsement to your WAS award might push you to explore unfamiliar territory. Ham radio is diverse, and a gentle nudge from the "carrot and the stick"

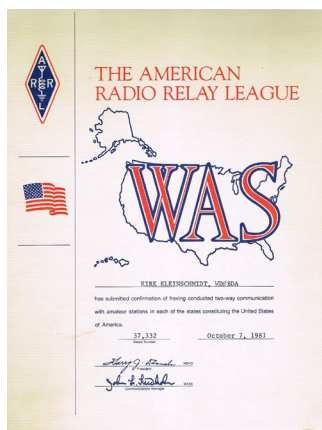

The author's vintage 1981 Worked All States award, age-related fading and all, is in dire need of some endorsement stickers.—NT0Z



The author's Alaska 50th Award, issued by the Great Outdoor Radio Club and celebrating Alaska's 50th year of statehood, is an example of an easy-to-achieve award that still looks good on the wall! Although no "extreme difficulty" endorsements are available, I worked my KL7 QSOs with QRP and an indoor antenna anyway!—NT0Z

offered by achievement awards might make all the difference.

Many (most?) hams are working on an award or two. It's an activity that can stick with you your entire on-air career. You might as well investigate now, especially if you have some bare spots on your shack walls that need "covering!"

❖ Old-Timers Call it Wallpaper

Veterans of the radio trenches call the pursuit of operating achievement awards "chasing paper." It's the amateur radio equivalent of professionals who proudly display various degrees and diplomas on their office walls, or military officers who wear every medal, ribbon and star on their dress uniforms. If you peruse the photos in some ham radio magazines (especially from the '70s and '80s) you will come across photos of shacks that are actually wallpapered with certificates and QSL cards. The few, the proud, the certificate hunter!

As I hinted, now that the solar cycle is perking up, qualifying for awards that were practically impossible for the average ham during the past several years may now be much easier. Because most of us are working on several awards at once, there's no shame in choosing a bunch of certificates you can achieve now, while working toward others that may take a while.

If you're a real beginner you might set an initial goal to work all 10 US call sign districts.

When you've done that you'll probably have worked at least 20 out of the 50 states required for Worked All States. And when you've worked all 50 states, unless you've purposefully stuck to one band and one mode, you probably have already made significant progress toward Five-Band Worked All States (5BWAS) or WAS endorsed for SSB, CW or digital. In this way, progress in one award almost always leads to progress in others.

The sheer number of available awards and endorsements allows a tremendous level of flexibility, so if you don't know Morse code and just moved into a condo and don't want to risk SSB, work those states on QRP PSK31. A state's a state. It's all good! And when you finally learn Morse or move to a QTH that's more SSB friendly you can tie up any loose ends later on.

In addition to providing display opportunities for all of those QSL cards you'll be collecting, the great paper chase is a great motivator for improving your station, its capabilities and your own personal on-air skills. Use that to your advantage!

Unlike hard-core contesting, when you're chasing down awards contacts you're really only competing with yourself. Spend as much or as little time on the project as you like. There are thousands of awards and certificates to work toward, some easy, some almost impossible, and some actually impossible. In 50 years of dedicated operating you could only scratch the surface, so pick a few that sound interesting and let 'er rip.

❖ A Variety of Sponsors

Whether popular or obscure, operating awards are sponsored by a wide variety of entities and individuals, including ham radio magazines, national radio societies, local/regional clubs and associations, and even individuals. In this neck of the woods, many of the most popular awards are sponsored by the ARRL (www.arrl.org/awards). All of the European ham radio societies offer multiple awards, but some of the most popular are sponsored by the Radio Society of Great Britain (RSGB, www.rsgb.org/operating/awards).

You can earn awards for working all 10 call sign areas in Japan, for working 100 or more Russian districts (similar to US counties), or for working 100 or more "islands of the world" (IOTA, short for Islands On The Air). As you'll see a bit later, there's an award for just about everything.

Another longtime awards program is administered by *CQ* magazine. You can see them all at www.cq-amateur-radio.com/cq_awards/index_cq_awards.html. *CQ*'s Worked All Zones award is a real toughie, and many hams who have worked stations in hundreds of countries lack QSOs with stations in one or two rare zones (I have been missing one zone for more than 10 years, and running QRP to my indoor antenna will probably require awesome 10-meter propagation for me to have any chance of success).

CQ also administers the USA-CA award, which is like WAS on steroids. Although qualification starts at a "mere" 500, the ultimate certificate (a plaque, actually) rewards hams who

have confirmed contacts with stations in all 3077 USA counties! Amazingly, at press time, more than 1200 hams have earned the award since the first one was awarded in 1965. Even more amazing is that KZ2P has worked and confirmed contacts in all 3077 USA counties 13 times! Check your logbooks, because that's at least 40,001 confirmed QSOs!

A large list of worldwide awards can be found at www.ac6v.com/hamawards.htm, but the ultimate wallpaper archive and information resource is *The K1BV DX Awards Directory*, lovingly compiled by Ted Melinosky, K1BV, since 1987. Once published in hardcopy, the *Directory* has detailed information on more than 3300 awards and is now available free of charge at www.dxawards.com. This is an awesome resource, and the sheer number of amateur radio awards listed here will make you dizzy!

As you'll read in the *Directory* and elsewhere, most awards sponsored by national membership organizations require only "local" applicants to be members of that organization. To qualify for ARRL-sponsored awards, for example, US hams have to be ARRL members, while non-USA hams do not.

❖ Where to Begin?

Describing every available award would consume about five years' worth of *MT*'s published space allowance, but since K1BV has already handled that massive task, let me list just a few to whet your appetite.

First Contact Award – Perhaps the easiest amateur radio operating award to qualify for, the First Contact Award doesn't immortalize initial contact with an alien species (darn!). Instead, this ARRL certificate commemorates a beginning ham's first on-the-air contact. The printed certificate comes complete with the contact information as submitted by the award presenter (often the other ham in the notable QSO, a fellow club member or an Elmer). Because my first contact was generously commemorated decades ago with a QSL card and a personal letter of welcome and encouragement, I'm holding out for the SETI First Contact Award which, to the best of my knowledge, hasn't yet been awarded, or perhaps the Worked All 51 Areas Award, to be issued by the Groom Lake Amateur Radio Club.

Worked All Continents – WAC is a beginning HF DXer's first achievement award (and my first award save for an ARRL code proficiency certificate). Often much easier to qualify for than WAS, it's awarded by the International Amateur Radio Union for confirming contact with hams in the six continental regions of the world: Africa, North America, South America, Asia, Europe and Oceania (the South Pacific, including Australia, New Zealand and Hawaii). Endorsements are available for different bands and modes.

Worked All States – The Worked All States is a "bread and butter" award that works just like it sounds: Work and confirm contacts with hams in all 50 states. It's a hugely popular award among beginning hams. Aside from the basic certificate for any combination of bands/modes, specialty certificates and endorsements are issued for a variety of different bands and modes



Newer WAS certificates look high-tech and are in landscape formats. This one, awarded for confirming contacts with all 50 states on five bands, is an example of a difficult award that is still achievable with determination and elbow grease. The most difficult QSOs are typically with nearby states on the high bands and Alaska and Hawaii on the low bands.

such as Satellite, 160 meters, SSTV, RTTY and each VHF band. Available endorsements include SSB, CW, Novice, QRP, Packet, EME, and any single band. Sponsored by the ARRL.

The DX Century Club – After you've cut your teeth on WAC, you can step up to the global standard in DX achievement. The DXCC is awarded to hams who confirm contacts with fellow hams in 100 or more "DXCC entities" worldwide. Although countries such as Germany and Argentina are definitely DXCC entities, other areas such as Puerto Rico and Guam are also considered DXCC entities, which makes your job a little easier, if a bit more confusing!

As of July 2011 there are 341 entities on the official "ARRL DXCC List," which is available from the ARRL website at www.arrl.org/country-lists-prefixes. There you'll also find a complete list of rules and DXCC award endorsements.

VHF/UHF Century Club (VUCC) – Here's a great program for Techs and VHF/UHF enthusiasts. Sponsored by the ARRL, VUCC is awarded for confirming QSOs with hams in 100 maidenhead grid squares (on 6 or 2 meters, fewer as you move up in frequency). For more information about the grid square system, see http://en.wikipedia.org/wiki/Maidenhead_Locator_System. Even during solar cycle doldrums, E-skip and Tropo openings provide plenty of propagation for VUCC seekers.

Worked All Zones – This DX award, as I've discovered the hard way, separates the men from the boys. It's awarded for confirming contact with hams located in 40 geographic zones worldwide as defined by *CQ* magazine, the sponsor. Although "40 zones" seems like a *lot less* than "100 countries," don't be fooled. Some of the zones can take a lifetime to work – and I'm speaking from experience! After 30+ years of casual DXing I have yet to work a station in Zone 26, which includes Thailand, Cambodia and Vietnam.

If you need motivation to get on the air or to explore something new, chasing paper may be the perfect excuse. Besides, those bare shack walls need *something*!



More FTA Satellite and Readers' Questions

In last month's episode, I was extolling the virtues of the Manhattan RS1933 MPEG4 Free-to-Air (FTA) satellite receiver. Now, I'll give you the background on the story.

❖ Murphy Lends a Hand

Several months ago I had arranged to have a review unit of the new RS1933 receiver sent for evaluation from Skyvision. And, while the receiver was en route, there appeared to be something wrong with my 25 year-old, 36 inch dish actuator. When directed to a different satellite, the motor just sort of chattered for a second or two and stopped. They just don't make 'em like they used to! Well, it had been two and a half decades since I had ordered one and I was shocked that they are now over \$300 (and they say there's no inflation). Since that wasn't in the budget, I settled on a 24 inch actuator for half the price.

Luckily, the actuator arrived before the receiver did, so I had it mounted and ready to go by the time UPS brought the new receiver. Like all MPEG2 receivers, the RS1933 FTA receiver is "slaved" to whatever it is that you use to move your C/Ku-band dish, in my case a Motorola 4DTV receiver that's six years old. But, there was still a problem. The new actuator motor wasn't moving. A check with the volt meter showed the receiver wasn't putting out the

24 volts the motor was asking for. A quick check with the authorized Motorola 4DTV receiver repair outfit in North Carolina determined that the actuator transformer was probably at fault. So, I had to ship the 4DTV receiver off. Naturally, the next day the new RS1933 arrived.

A week later the 4DTV was back, everything was in place and appeared to be working perfectly. I was finally ready to put the receiver through its paces. But, there was another problem. Oh, the dish moved nicely (and quietly!) from one end of the arc to the other, but the polarity was not changing.

I could swap out the polar-rotor motor for about \$20 but I didn't want to wait for another part, so I went to the TVRO closet and found a brand-new WS International DMX741 C/Ku-feed with built-in LNBFs for both bands that I had bought months earlier for \$45. (Are you kidding me? You can't get one LNBF for that money or a feed horn, let alone the feed horn and both C and Ku-band LNBFs. Is that for real?) Yes, it's made in China and the metal bends easily, but this seemed like a good time to try something new. Would it actually work or was it total junk?

❖ LNBF Idiosyncrasies

The technical difference between the two is that in the old feed horn the polarity is changed with a small servo motor that rotates the small antenna in the throat of the feed horn so that it has vertical or horizontal polarity corresponding to how the satellite transponders are set up. The other one has two small antennas 90° apart in the throat of the feed horn that are electronically selected for horizontal or vertical polarity. The big LNBF advantage: no moving parts.

LNBF stands for Low-Noise Block down-converter Feed horns and they have been around for at least twenty years. The photo on this page, showing the comparison of the two, speaks for itself. The traditional feed horn/LNB assembly

vs the all-in-one feed has a cost difference of about \$250.

One of the advantages of the servo-driven feed is that your installation doesn't have to be perfect, because you can skew the polarity to compensate for the dish system not being set up exactly right. The LNBF system has no room for error; your installation has to be perfect to let it see both polarities equally well and it takes a lot of adjustment to do this. These adjustments actually help to peak the dish to maximum capability, resulting in even better performance.

❖ DMX741 Performance

I was prepared for the worst. How could a feed horn/LNB assembly costing a fraction of the traditional assembly perform at anywhere near the level of the old standard? Once I had the feed horn adjusted, I started looking for feeds in the C-band range. The ten foot dish I use is optimized for C-band frequencies and I was not disappointed.

On Canada's Anik F1R (107.3°W) I found CBC-TV in all time zones from Nova Scotia to British Columbia; programming unavailable to U.S. viewers in over ten years. I've set timers to watch the "Rick Mercer Report" Tuesdays at 8 pm followed by "This Hour has 22 Minutes" – two top Canadian comedy shows. And, since the Manhattan RS1933 was an MPEG4 receiver, the programming was in HD. On Galaxy 28 (89°W) NASA-TV had four channels including NASA-TV-HD. On that same satellite was a number



Traditional Chaparral international C/Ku-band feed horn (left) with C and Ku-band LNBFs, a total cost of over \$300 vs WS DMX741 feed horn (right) with built-in C and Ku-band LNBFs, about \$45. (Courtesy: Author)





CBC-TV from Canada in HD across all time zones in MPEG4 DVB-S2 8PSK. (Courtesy: Author)

of retro-TV channels that play old movies and old TV shows. The Manhattan can receive both MPEG2 and MPEG4 signals.

But, what about Ku-band? These ten foot dishes aren't really optimized for Ku-band. I have a four foot spun aluminum dish that has far better gain on Ku-band than the mesh ten-footer. I went first to AMC-21 (125°W) and found the PBS-HDTV feeds, which were quite impressive. At SES-1 (101°W) I found BVN-TV, the Dutch and Flemish public television service as well as Radio Netherlands Worldwide. The blind search feature on the RS1933 found numerous unannounced news and sports feeds on Ku-band. There's no doubt in my mind that, while the DMX741 might not match up well with the Chaparral on a spec sheet, it does well on Free-to-Air MPEG2, MPEG4 and DigicipherII broadcasts.



Four channels of NASA-TV including NASA-HD. (Courtesy: Author)

The DMX741 is also quite versatile. You can configure it for Ku-only reception, C-band only, C/Ku-band using only one coax cable, or C/Ku-band using two separate coax cables, which is how I have it configured. It comes with a short coax jumper cable that lets you set it up for C/Ku-band on one coax, which would be particularly useful on a fixed C/Ku-band dish. I bought the DMX741 at www.sadoun.com for \$45 plus shipping, but it is available at many other satellite TV online retailers for a similar price.

❖ More Comment on Wi-Fi Radio

My December column regarding listening to Internet radio in a non-FiOS home continues to bring response from readers.

Ed Rogers wrote, "I enjoyed your article in the December *Monitoring Times*. I wanted to pass on that Best Buy carried the Logitech Squeezebox, but it is not immediately easy to find. I received

one last September and both my wife and I get a ton of use out of it. She is from England and enjoys listening to the BBC and Classic FM without need for a computer."

Thanks Ed for the tip on Best Buy. Indeed, I had to hunt around on their website before it came up for me. Their price was \$179 at the time of this writing which is comparable with other retailers.

Jim Stellema KA8ZXJ wrote, "Thanks for your article in the December 2011 issue on Wi-Fi Internet radio and in particular the Squeezebox. Logitech has a limited time special selling the Squeezebox (white) and the battery pack/remote accessory pack, the entire package is \$119.00 including shipping. I have one on order."

Excellent, Jim, you got the best deal I've seen yet! By the time I went back to the website the deal was over. I found the product at B&H Photo online for \$150 plus shipping and Crutchfield still carries it at \$170. Of course, there are dozens of similar WiFi Internet radios on the market, several of which are carried in the Grove catalog; here's a link to their offerings: www.grove-ent.com/wifireceivers.html. They carry several Sangean products from \$173 to \$280. They also carry several Grace models from \$130 to \$200. Check out the reviews from Loyd Van Horn's column over the last several years for details on these and other brands and models.

❖ Chasing HD-Radio

Longtime *MT* reader Morgan Little is frustrated with HD-FM activities in his area. "The favorite local FM stations are upgrading to IBOC [the digital scheme which stands for In Band On Channel and which is promoted as HD-Radio®] in great numbers. One from San Antonio is hardly available after the upgrade. The other, a real favorite, is starting upgrades tomorrow. We are further than 65 miles from this station, so getting them after the upgrade may be a real trick! The good news is we are on a hill with few structures around to interfere."

He has an HD-capable receiver and is looking at ways to improve reception without resurrecting his large VHF-TV-FM antenna he had taken down because of very active lightning in his area.

Strange things happen when stations switch into "hybrid" mode, broadcasting both an analog and IBOC signal. The biggest problem is that the IBOC transmission is roughly one-tenth that of the analog. So, if a station is transmitting 100,000 watts, the legal limit for a U.S. FM station, their IBOC transmission would be only 10,000 watts. But, most public radio stations broadcast far less than that. The only public radio IBOC FM station near my own location transmits 17,000 watts in analog and 1,700 watts IBOC. You can imagine that from 50 miles away the analog signal is very strong but the HD logo rarely lights up on their IBOC signal.

I had suggested that Morgan invest in WiFi radio and listen that way, but he advises that in his location only dial-up is offered and he's not about to invest in WildBlue. He's also not near enough to a 3G wireless broadband tower to make that work either. That leaves him with the Over-the-Air FM route. If he does go that route, there are steps to take to lessen the chances of having lightning damage.



One is to ground the antenna mast with an eight foot copper electric company-style ground rod (not a four foot copper-clad Radio Shack special) and a heavy duty ground strap. The next step is to run the coax from the antenna to the house through a ground block (RS#15-923 for \$5.50). The final step is to disconnect the antenna lead at the receiver, the power from the wall socket and any other interconnected devices when there's a severe thunderstorm imminent. It may be a pain in the neck to do, but it works.

Of course, the hill on which he lives is both a help and a hazard. Being the highest point in an area gives you a great signal vantage point and an easy path for lightning. Folks who don't live in areas pounded regularly by severe thunderstorms may wonder what all the fuss is about, but those of us who do, have scary tales to tell of lightning shooting out of electrical outlets and down from ceiling fans. I once had a nearby lightning strike that killed five mature oak trees in one flash. Another hit blew a ten foot slab of oak bark off a tree and over the house. That particular strike dug a thirty foot long trench six inches deep to the nearest power pole. Needless to say, the power transformer was toast, too.

CC WiFi Internet Radio



**Receive Your Favorite Stations*
Over 18,000 Available Worldwide**

- Excellent, Clear Audio
- Works on Any Broadband Signal
- Real, MP3, WMA Formats
- 99 Presets
- Wireless or Direct Connection via Ethernet Jack, Line-Out, Headphone, Signal Strength Indicator
- No Subscription Fee

* Your favorite station must stream audio. You must have broadband internet service.

\$139⁹⁵

C. CRANE

Free Catalog

800-522-8863 • ccrane.com



PROGRAMMING SPOTLIGHT

WHAT'S ON WHEN AND WHERE?

Fred Waterer

fredwaterer@monitoringtimes.com

www.doghousecharlie.com/radio

Cruising around the Dials

Welcome to frigid February, at least in most of North America. When one is dealing with an Alberta Clipper, frigid arctic winds that blow in from the west, nothing is better than a hot drink, a warm receiver (or computer) and the hot sounds of radio from the south. This month we will shine the *Programming Spotlight* on a couple of African subjects, then we'll set sail for Ireland, followed by cruising with the most incompetent crew in the Royal Navy. Then we'll investigate a few radio personalities who have achieved a form of immortality.

❖ Africa

Africa No. 1 – Gabon. One of the best sources of hot sounding radio originates in the African nation of Gabon. I have spent many winter hours listening to the sounds of African “High Life” music from Libreville, Gabon via shortwave radio station **Africa Numero 1**. The mix



of African rhythms and electric guitars is out of this world. Understanding a bit of French helps, but is not necessary to enjoy the programming.

On the shortwave bands, try for Gabon on 9580 kHz after 0500 UTC or later in local afternoons. Africa No.1 also has a website, but the audio, at least in my experience, is sometimes hit and miss. Try www.africa1.com and click the big black button at the top of the page. While the high life music is the big draw, quite often one can hear news of the region (in French) and many other types of music. One day in December while checking to see if the Internet audio was working, continuous songs by a very young Michael Jackson were heard. There is always something interesting to be heard from this African nation. Give it a try on a cold winter day or night; your ears will thank you!

Some very good programming dealing with Africa originates outside the region. The **BBC**, **Deutsche Welle**, **Radio France International**, **Radio Netherlands** and others have programs specifically targeting the African continent and/or the African Diaspora throughout the world.

One of the more interesting, and newer programs is from the **Voice of America** and is called **South Sudan in Focus**. The VoA website refers to this program as **Sudan in Focus** but the program identifies itself as **South Sudan in Focus**. This 30-minute program is a window

onto a nation and a conflict which receives scant attention in the West.

South Sudan, one of the world's newest countries, is busy resolving issues with Sudan, from which it seceded. Disputes between the two nations include final demarcation of the border (armed border conflict is ongoing), financial issues arising from the split and oil issues (South Sudan has oil, Sudan has a pipeline). South Sudan plans to build a new capital city, raising questions of how the government will pay for it. Crime is also an issue in the current capital of Juba, where 6 people are killed on average every day! Other reports on the program looked at press freedom in South Sudan and regional news from neighbors such as Ethiopia and the Congo.

John Tanza hosts the program in Washington, with **Charlton Doki** reporting from Juba, South Sudan. All in all, this VoA program is well worth following on a regular basis. It is heard Monday to Friday at 1630-1700 UTC on 9790, 11905 and 13635 kHz. The program can also be heard online or downloaded as a podcast at www.voanews.com/southsudan. One can contact the show at sudanproject@voanews.com

❖ Ireland

Seascapes – This is the excellent maritime program presented by Ireland's **RTE 1**. It is hosted by **Marcus Connaughton**. Connaughton presents a fascinating and entertaining look at all sorts of subjects related to the sea and sailing each week. Some subjects have included courage at sea (ships in distress), a discussion about the ancient art of sail making, a look at the water birds of Ireland, reports from a yacht race, or a history of lifesaving along the Irish coast. One program segment speculated on what seaport Handel might have used on his way to England.

As you can see, it is a comprehensive and varied digest of maritime news and information. It is not your typical shipping digest.

Thanks to the Internet one can listen worldwide either live at the scheduled times, or listen to the podcasts of the program. Listen to the podcast archive online, or subscribe to it and download them via your preferred podcasting software. Another service offered by the program is a weekly “head's up” newsletter letting one know what will be on that week's program. This is available by dropping an email to seascapes@rte.ie

The program is heard at 1030 pm local time Fridays, 2230 UTC, and repeated Mondays at 502 am local, that is, 0502 UTC. Check it out at

www.rte.ie/radio1/seascapes/#Podcasts Listen live at www.rte.ie/radio1

❖ The Navy Lark

Continuing our nautical theme, one of the classic British radio comedies is **The Navy Lark** heard weekly on **BBC Radio 4extra**, the former **BBC 7**.

The program debuted in 1959 and ran until 1975. It starred **Leslie Phillips** and **John Pertwee** among others, but a young **Ronnie Barker** (later to gain fame as one of the **Two Ronnies**) quite often stole the show.

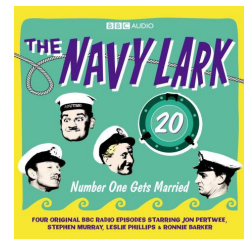

Think of this program as McHale's Navy with British accents. It revolves around the improbable adventures of the misfit crew of **HMS Troutbridge**. Sub Lieutenant Phillips (Ensign Parker?) inevitably crashes the ship into a wharf or runs it aground, after issuing completely incomprehensible orders to the wheelsman. Chief Petty Officer Pertwee (McHale?) is always up to some shady scheme, usually aided by Able Seaman Fatso Johnson (Barker). Most episodes revolve around efforts to keep all this mayhem from Captain Povey. (Captain Binghamton?) Barker demonstrates his gift for eccentric characters and accents in almost every episode as a doddering old admiral, or a less than brilliant intelligence officer.

This program was one of the longest running and funniest BBC radio situation comedies ever made. The program can usually be heard on Fridays, and like most BBC radio programs can be heard for up to 7 days afterwards online. Go to www.bbc.co.uk/radio4extra/programmes/schedules. There were over 200 episodes of the program made, and every one of them is amusing. It should be noted, however, that having been made in an earlier, less politically correct time, some of the humor may seem a bit out of date, even sexist at times. Still, it was a product of its times and should not be judged too harshly. Fans of Ronnie Barker will relish it!

❖ Recommended Listening

CBC Radio One – Quirks and Quarks. Science has always fascinated me. I grew up with the “Space Race” and *Star Trek*. I was surrounded by people who taught me to “stay curious” about everything. One program that never fails to teach me new things is **CBC's**

long running *Quirks and Quarks* program. Over its almost 35 year run, *Quirks and Quarks* has been hosted by three of the giants of science and science broadcasting.

The first host was **Dr David Suzuki**, a respected academic, science broadcaster and environmentalist. He has spent over 40 years explaining science in layman's terms, beginning with a weekly science program for children on Canadian television (*Suzuki on Science*) then via *Quirks* on **CBC Radio**, and *The Nature of Things*, a CBC Television program seen in 40 countries. After hosting *Quirks* for 4 years, he turned the program over to **Jay Ingram** who hosted until 1992. **Ingram** was perhaps my favorite host of the program. He has an uncanny ability to explain complex scientific ideas in terms that make them easily understandable. He has since moved on to television, hosting *Daily Planet* on Discovery Channel Canada.

In 1992, current host **Bob McDonald** took over *Quirks* and has continued to moderate the discussions until the present day. Like Ingram, he has a knack for explaining science in a very entertaining way. When he is not hosting *Quirks*, he is the **CBC's** "go to guy" when anything scientific is discussed on the network. Of particular interest are the occasional *Quirks* "mailbag" shows in which they answer listener's questions about anything and everything scientific. The program can be heard Saturdays at noon, Mondays at 11pm and Wednesdays at 3pm local time. One can also try the **CBC Northern Quebec Service** on 9625 kHz at 1700 UTC Saturdays, 0400 UTC Tuesdays and Wednesdays at 2000 UTC.

Quirks & Quarks has won more than 80 national and international awards for science journalism. As part of the **CBC's** 75th anniversary celebrations in 2011, a page featuring clips of McDonald's work at the **CBC** was posted. It makes for quite a stroll down memory lane, featuring many anecdotes about his long science broadcasting career. You can access it at www.cbc.ca/75/2011/09/bob-mcdonald-wonderstruck.html You can also subscribe to the *Quirks and Quarks* podcast at www.cbc.ca/podcast

❖ The Immortality of Broadcasting

Some people write off religious broadcasts. No doubt there are some hucksters out there. But there are just as many sincere people of faith broadcasting every day. There are multi-million dollar ministries, and there are people who scrape up enough money to finance half an hour a week at 4:00 am in order to do their part to spread the Gospel, as they interpret it. I've always been intrigued by the variety of viewpoints. You will find them all on the shortwave bands.

Christian broadcasting has been around as long as radio itself. Fessenden's first broadcast in 1906 featured a hymn and a Bible passage (Luke 2:14). The term *broadcasting* itself may

derive from an early radio pastor who likened the radio ministry to planting seeds over a wide area with a "broad cast."

Recently I was struck by how many evangelists continue to preach "The Word" long after they have gone on to their reward. One of the ubiquitous voices on the shortwave bands is that of Dr. Gene Scott. Having listened to him for over 20 years, off and on, quite frankly I still don't quite know what to make of him. He was as colorful a character as anyone who has ever been heard on radio.

I first heard of him in the 1980s, when a fellow DXer/penpal in Nevada told me about him and his "funny hats." Later he appeared on television in Buffalo, NY for a short time and I had the opportunity to see him first hand. (This experiment didn't last very long, presumably donations from this region didn't live up to expectations.) Fast forward to sometime around 1990, and with the advent of WWCRC, Scott was on shortwave 24 hours a day. "Doc around the clock," as it were.

I listened to him quite often for the next few years. He was a very charismatic speaker and I found his *shtick* quite fascinating. He was always reading some strange book as part of his "teaching." Sometimes it was about the Bermuda Triangle, other times about Crystal Skulls or secret societies. They were the type of books popular in the 1970s. Usually in the middle of these readings he would stop and in his booming voice, command his listeners to "get on the telephone" which they presumably did, in large numbers. (One particular evening he had blasted the people working for him answering the telephones for some transgression. I phoned that night, more out of curiosity to see what would happen. The poor guy at the other end of the line didn't sound too happy.)

My mailing address was provided and shortly thereafter some material was received in the mail. Then I never heard from them again. (Then again, I didn't send any money.) Some articles suggest that Scott's church was a multi-million dollar operation. Judging by the number of times he would yell "Get on the telephone" it wouldn't surprise me at all. He lived in a lavish home, owned horses, and was a renowned philatelist and collector of rare Bibles. He was also well known as a philanthropist.

In later years he seemed to get away from the dime store science fiction and stick to preaching. Shortly after remarrying, Scott was diagnosed with cancer and passed away a few years ago. His widow, Melissa took over his ministry which continues to this day. She is not quite as flamboyant as "Doc"; she sticks to teaching and preaching. The programming of Pastor Melissa Scott, heard evenings on 5935 and 6090 kHz and online at www.pastormelissascott.com (click The Live Program) seems equally divided between recent teachings by Melissa and recorded teachings by Gene. They seem to have dispensed with the "weird" stuff from his earlier teachings and stick to his theological discussions. While Scott may have left the physical world, it appears he will continue teaching and commanding his followers to "get on the telephone!" for years to come via radio and the Internet.

Gene Scott is not the only radio pastor who continues to preach "beyond the grave." Lester Sumrall continues to minister via the miracle of audio recordings. Sumrall was the founder of LeSea Broadcasting which gave us World Harvest Radio. According to the WHRI schedule, Sumrall can be heard several times per day.

Yet another Bible teacher whose ministry goes on without him was J. Vernon McGee (1904-1988) of the *Thru the Bible* radio program. This daily program is heard throughout North America and at one time on many shortwave outlets. It can still be heard via HCJB Australia and a few Trans World Radio stations, according to their website. I liked Dr. McGee. He had a folksy way of presenting his program, which was a survey of the entire Bible in 5 years.

I find it interesting how radio and the Internet give these men a sort of immortality. Radio followers must derive some comfort and encouragement from their continued broadcasts. Clearly these ministries still receive enough financial support to continue without them.

One of the interesting things about the invention of sound recording, is the possibility that one's voice, thoughts, opinions and ideas live on long after the person uttering them has passed away. This is true of many of the great comedians and dramatists of the twentieth century. Just this morning, as this is written, Orson Welles and Lionel Barrymore were heard in the Campbell Playhouse version of "A Christmas Carol." Jack Benny, Fred Allen, Jack Webb and Lucille Ball, along with thousands of others continue to entertain and amuse long after their deaths. Who says immortality is not possible?!

NASB

National Association of Shortwave Broadcasters

Representing the privately-owned shortwave stations in the USA

- Find links to all of our members at www.shortwave.org
- Take the NASB Shortwave Listener Survey and get a free subscription to the NASB Newsletter. www.surveymonkey.com/s/6LRVLJ7
- Listen to "The Voice of the NASB" on HCJB's DX Party Line on WRMI's 9955 kHz. Visit www.wrmi.net for schedule
- NASB is a member of the HFCC (High Frequency Coordination Conference) and the DRM (Digital Radio Mondiale) Consortium

THE QSL REPORT

VERIFICATIONS RECEIVED BY OUR READERS

Gayle Van Horn, W4GVH

gaylevanhorn@monitoringtimes.com

http://mt-shortwave.blogspot.com

Twitter @QSLRptMT



Rhein Main and Special Event QSLing

Harald Gabler informs shortwave listeners of this year's calendar offer. Rhein-Main Radio Club of Frankfurt, Germany, and ADDX announce the seventh edition of their QSL Calendar 2012. The new color calendar is in English and offers a real treasure from the club's historical QSL archives, covering QSL cards from the 1930's to present.

The cost is 15 Euros, including shipment worldwide. Mr Gabler noted, "It is rare, unique and special for the DXer and radiofreaks."

You may order from the website at www.rmrc.de or email DrGabler@t-online.de

Postal orders go to: Harald Gabler, RMRC.e.V., Postfach 700849, 60558 Frankfurt /M, Germany.

February offers new special event QSLing opportunities for shortwave listeners and amateur radio operators. Operating stations offer QSL cards or certificates as indicated. Four favorites include:

Feb. 4, Shuttle Columbia Commemorative Special Event Station, 1500-2200 UTC. Operating on 28.540, 21.340, 14.240, 7.240 MHz. W5NAC, Nacogdoches Amateur Radio Club. **QSL**. NARC, 167 CR 2093, Nacogdoches, TX 75965. www.w5nac.com

Feb. 4, Commemorating Groundhog Day at Punxsutawney Airport, 1400-2100 UTC. 14.330, 7.183, 3.845, 147.390 PL 173.MHz. K3HWJ,

Punxsutawney Area Amateur Radio Club. **Certificate**. Mike Miller, N3HBH, 1097 Wishaw Rd, Reynoldsville, PA 15851. <http://sites.google.com/site/punxyhamclub>

Feb. 18-19, George Washington Special Event. Commemorating George Washington's 280th birthday from his estate, 1600-2100 UTC. 14.240, 7.240, 7.035 MHz. K4US, Alexandria, Virginia, Mount Vernon Amateur Radio Club, **Certificate**. Mount Vernon ARC, Box 7234, Alexandria, VA 22307. Email: k4us@mvarc.com or website: www.mvarc.org

Feb. 20-26, Antarctic Activity Week - 9th Edition, Worldwide, OT. Worldwide Antarctic Program (WAP). This is an all bands, all modes worldwide event celebrating the international scientific work in Antarctica, 0000-2359 UTC, 28.450, 21.350, 14.250, 7.150 MHz. **Certificate and QSL**. Certificates may be obtained from the WAP, and QSLs from the WAP-Reference Numbered stations worked. See WAP website www.waponline.it for details, or in United States you may e-mail questions to: kb0mzf@arrl.net.



AMATEUR RADIO

Nicaragua HT2N: YN21. Full data color wildlife postcard of Volcean Mombacho Reserve. Received in 55 days for report to: Michael T. Kasrich, 2340 E. Boccock Road, Marion, IN 46952 USA (Larry Van Horn, NC).

Western Kiribati-IOTA: OC-017/ T30AQ, 12 meters SSB. DXpedition via SP5EAQ. Full data color scenery card. Received in two weeks for \$2.00US and nested Euro envelope. QSL address: Jacek Marczewski, Podlesna 8, Jazgarzewszayna, o5-501 Piaseczno 4, Poland (Van Horn).

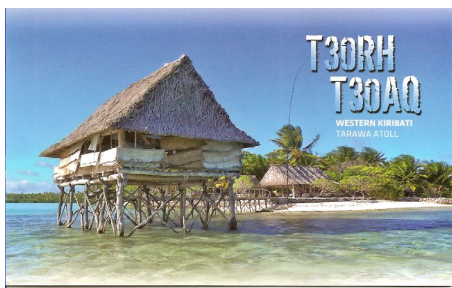

in less than three hours. Veri signer notes address for postal reports is: AFN Europe, Frequency Management, CMR 418, Unit 29405, APO AE 09058 USA (Albert Muick, PA/HCDX). Send E-reports to: glenn.wells@us.army.mil

KKXA, 1520 kHz AM. Snohomish. Full data Everett scenery QSL card signed by Andy Skotland, General Manager. Received in 85 days for a CD report. Station address: 2707 Colby Avenue, Suite 1380, Everett, WA 98201 USA (Patrick Martin, Seaside, OR).

KSL, 1160 kHz AM. KSL Newsradio. Full data station logo card, signed by John Dehnel, Chief Engineer. Received in ten days for a mediumwave report and return mint postage. Station address: 5 Triade Center, 55 North 3rd West, Salt Lake City, UT 84180-1109 USA (Muick).  Streaming audio www.ksl.com

WGBW, 1590 kHz AM. Large full data QSL card signed by Mark Heller-Chief Engineer. Card features black and white retro echo stamp and call-sign. Also sent a black logo T-shirt with copy of the Denmark newspaper, which included an article on WGBW. Received in 14 days for a CD report. Station address: P.O. Box 100, Denmark, WI 54208-0100 USA. What a great packet of goodies! (Martin).

CLANDESTINE

Radio Free Sarawak, 17560 kHz. Full data verification letter. Received in eight days for English report and one IRC. QSL address: c/o Bruno Manser, Fonds, Socinstrasse 37, CH-4051 Basel, Switzerland (Roberto Pavanello, Italy/playdx).

Radio Y'Abaganda via Issoudun, France, 15410 kHz. Full data E-QSL including transmitter site notation from Alex Kalazani Kigongo, who apologized for 38 hour response delay. E-report sent to: info@ababaka.com. Reply from Mr Kigongo at: ababaka.com@gmail.com (Wendel Craighead, KS).

MEDIUM WAVE

Germany-AFN Europe, Weisskirchen, 873 kHz AM. Full data logo/towers E-QSL card from Glenn Wells, Frequency Manager, AFN Europe. Received

Communications & Traffic Services Iqaluit Centre, M.C.T.S., Central & Arctic Region, Department of Fisheries & Oceans, P.O. Box 189, Iqaluit, Nunavut XH0 Canada (Patrick Robic, Austria/UDXF).

China-BPM 5000 kHz Time Signal Station. Full data QSL card and personal handwritten note from Changhong Liu. Received for an English E-report and MP3 to: ch.117@ntsc.ac.cn (Bruce Portzer/HCDX).

Chile-ECO01-ONEMI Región de Tarapacá, 9150 kHz. No data verification email from Ernesto Figuero Brito, Director Regional. Received in four hours for email report to: efigueroa@onemi.gov.cl (Robic).

Ecuador-HD2IOA, 3810 kHz. Time Signal Station, Station QSL card and brochure. Received in 25 days for Spanish E-report to: inocar@inocar.mil.ec Postal address: Instituto Oceanografico de la Armada, Casilla 5940, Guayaquil, Ecuador (Frank Hillton, Charleston SC).

Finland- 25000 kHz. Mikes Time Signal Station. Full data verification letter from Kalevi Kalliomaki. Received in 20 days. Station address: Centre for Meteorology and Accreditation, P.O. Box 9, Tekniikan tie 1, FI-02151 Espoo, Finland (Francesco, Italy). Received same in 10 days (Pavanello).

Italy, IBF da Torre Bert, 5000 kHz. Time Signal Station. Full data E-QSL from Giampiero Bernardini, QSL Manager. Received in eight days for E-report to: QSL@radiomaria.org Station reported as operating on a temporary basis pending approval for full broadcasting operations (Dario Montferini, Italy/playdx).

USA-KSM Bolinas, California, 16914 kHz. Data only KSM Radiogram signed by Paul Shipp, Maintenance. Received in 59 days for utility report and \$2.00US. Station operates every Saturday, schedule is available at www.radiomarine.org QSL address: P.O. Box 175, Valley Springs, CA 95252 USA (Muick).

UTILITY

Brazil-PPE, 10000 kHz. Time Station. Friendly no-data English verification letter from Ricardo Jose de Carvalho, head of Time Service Division. Brochure on National Observatory and sticker/seal celebrating 180 years of National Observatory affixed to QSL. Received in 37 days for a Portuguese report and two IRCS. Station address: Divisão Serviço de Hora (DSHO), Observatório Nacional, R. Gal, Jose Cristiano 77, São Cristóvão, Rio Janeiro, CEP 1092 400 Brazil (Muick).

Canada-VFF Iqaluit Coast Guard, 12577 kHz. Full data verification letter signed by Jean Pierre Lehpert, Officer in Charge. Postcard, pin and station information brochures included. Received in 67 days. Station address: Canadian Coast Guard, Marine



HOW TO USE THE SHORTWAVE GUIDE

0000-0100 twhfa USA, Voice of America 5995am 6130ca 7405am 9455af
 ① ② ⑤ ③ ④ ⑥ ⑦

CONVERT YOUR TIME TO UTC

Broadcast time on ① and time off ② are expressed in Coordinated Universal Time (UTC) – the time at the 0 meridian near Greenwich, England. To translate your local time into UTC, first convert your local time to 24-hour format, then add (during Standard Time) 5, 6, 7 or 8 hours for Eastern, Central, Mountain or Pacific Times, respectively. Eastern, Central, and Pacific Times are already converted to UTC for you at the top of each hour.

Note that all dates, as well as times, are in UTC; for example, a show which might air at 0030 UTC *Sunday* will be heard on *Saturday* evening in America (in other words, 7:30 pm Eastern, 6:30 pm Central, etc.).

FIND THE STATION YOU WANT TO HEAR

Look at the page which corresponds to the time you will be listening. English broadcasts are listed by UTC time on ①, then alphabetically by country ③, followed by the station name ④. (If the station name is the same as the country, we don't repeat it, e.g., "Vanuatu, Radio" [Vanuatu].)

If a broadcast is not daily, the days of broadcast ⑤ will appear in the column following the time of broadcast, using the following codes:

<u>Codes</u>	
s/Sun	Sunday
m/Mon	Monday
t	Tuesday
w	Wednesday
h	Thursday
f	Friday
a/Sat	Saturday
occ:	occasional
DRM:	Digital Radio Mondiale
irreg	Irregular broadcasts
vl	Various languages
USB:	Upper Sideband

CHOOSE PROMISING FREQUENCIES

Choose the most promising frequencies for the time, location and conditions.

The frequencies ⑥ follow to the right of the station listing; all frequencies are listed in kilohertz (kHz). Not all listed stations will be heard from your location and virtually none of them will be heard all the time on all frequencies.

Shortwave broadcast stations change some of their frequencies at least twice a year, in April and October, to adapt to seasonal conditions. But they can also change in response to short-term conditions, interference, equipment problems, etc. Our frequency manager coordinates published station schedules with confirmations and reports from her monitoring team and MT readers to make the Shortwave Guide up-to-date as of one week before

print deadline.

To help you find the most promising signal for your location, immediately following each frequency we've included information on the target area ⑦ of the broadcast. Signals beamed toward your area will generally be easier to hear than those beamed elsewhere, even though the latter will often still be audible.

Target Areas

- af: Africa
- al: alternate frequency (occasional use only)
- am: The Americas
- as: Asia
- ca: Central America
- do: domestic broadcast
- eu: Europe
- me: Middle East
- na: North America
- pa: Pacific
- sa: South America
- va: various

Mode used by all stations in this guide is AM unless otherwise indicated.

MT MONITORING TEAM

Gayle Van Horn
 Frequency Manager
 gaylevanhorn@monitoringtimes.com

Larry Van Horn, MT Asst. Editor
 larryvanhorn@monitoringtimes.com

Additional Contributors to This Month's Shortwave Guide:

Thank You to ...

ADXC; BCL News; Cumbre DX; DSWCI-DBS 2011; DSWCI-DX Window; DX Asia; DX India; HFCC; Hard-Core DX; JPNpremium; DX Mix News 704-707; BC-DX WWDXC Top News; Nagova DX Circle.

A.J. Janitschek/Radio Free Asia, Washington, DC; Alokesh Gupta, New Delhi, India; Alan Roe, Ashik Eqbal Tokon, UK; Bob Fraser, ME: Derek Kickbush/HCJB Global Australia; Elena Osipova/Voice of Russia; Gerald Koopal, Netherlands; Ivo Ivanov, Bulgaria; Rachel Baughn/MT; Sean Gilbert UK/WRTH; Victor A. Goonetilleke, Sri Lanka; Wolfgang Bueschel, Stuttgart, Germany.

SHORTWAVE BROADCAST BANDS

kHz	Meters
2300-2495	120 meters (Note 1)
3200-3400	90 meters (Note 1)
3900-3950	75 meters (Regional band, used for broadcasting in Asia only)
3950-4000	75 meters (Regional band, used for broadcasting in Asia and Europe)
4750-4995	60 meters (Note 1)
5005-5060	60 meters (Note 1)
5730-5900	49 meter NIB (Note 2)
5900-5950	49 meter WARC-92 band (Note 3)
5950-6200	49 meters
6200-6295	49 meter NIB (Note 2)
6890-6990	41 meter NIB (Note 2)
7100-7300	41 meters (Regional band, not allocated for broadcasting in the western hemisphere) (Note 4)
7300-7350	41 meter WARC-92 band (Note 3)
7350-7600	41 meter NIB (Note 2)
9250-9400	31 meter NIB (Note 2)
9400-9500	31 meter WARC-92 band (Note 3)
9500-9900	31 meters
11500-11600	25 meter NIB (Note 2)
11600-11650	25 meter WARC-92 band (Note 3)
11650-12050	25 meters
12050-12100	25 meter WARC-92 band (Note 3)
12100-12600	25 meter NIB (Note 2)
13570-13600	22 meter WARC-92 band (Note 3)
13600-13800	22 meters
13800-13870	22 meter WARC-92 band (Note 3)
15030-15100	19 meter NIB (Note 2)
15100-15600	19 meters
15600-15800	19 meter WARC-92 band (Note 3)
17480-17550	17 meter WARC-92 band (Note 3)
17550-17900	17 meters
18900-19020	15 meter WARC-92 band (Note 3)
21450-21850	13 meters
25670-26100	11 meters

Notes

- Note 1 Tropical bands, 120/90/60 meters are for broadcast use only in designated tropical areas of the world.
- Note 2 Broadcasters can use this frequency range on a (NIB) non-interference basis only.
- Note 3 WARC-92 bands are allocated officially for use by HF broadcasting stations in 2007 WRC-03 update. After March 29, 2009, the spectrum from 7100-7200 kHz will no longer be available for broadcast purposes and will be turned over to amateur radio operations worldwide
- Note 4

"MISSING" LANGUAGES?

A **FREE** download to MTXpress subscribers, the online MTXtra Shortwave Guide is 115+ pages of combined language schedules, sorted by time. Print subscribers: add the MTXtra SW Guide to your subscription for only \$11.95. Call **1-800-438-8155** or visit **www.monitoringtimes.com** to learn how.

SHORTWAVE GUIDE

0000 UTC - 7PM EST / 6PM CST / 4PM PST

0000 0030	Egypt, Radio Cairo	6270na	
0000 0030	USA, BBG/Voice of America	7560as	
0000 0045	India, All India Radio/External Svc	6055as	
	7305as	11645as	13605as
0000 0045	USA, WYFR/Family Radio Worldwide	11720ca	
0000 0057	Canada, Radio Canada International	9880as	
0000 0057	China, China Radio International	6005as	
	6020na	6180as	7350eu
	9425as	9570as	11650as
	11885as	11790as	
0000 0100	Anguilla/Caribbean Beacon/Univ Network		
	6090na		
0000 0100	Australia, ABC NT Alice Springs	4835do	
0000 0100	Australia, ABC NT Katherine	5025do	
0000 0100	Australia, ABC NT Tennant Creek	4910do	
0000 0100	Australia, Radio Australia	9660pa	12080pa
	13690va	15240va	17715va
	17795va	17750va	
0000 0100	Bahrain, Radio Bahrain	6010me	
0000 0100	Bulgaria, Radio Bulgaria	5900na	7400na
0000 0100	Canada, CFRX Toronto ON	6070na	
0000 0100	Canada, CFVP Calgary AB	6030na	
0000 0100	Canada, CKZN St Johns NF	6160na	
0000 0100	Canada, CKZU Vancouver BC	6160na	
0000 0100	Cuba, Radio Havana Cuba	5040ca	
0000 0100	Malaysia, RTM Kajang/Traxx FM	7295do	
0000 0100	Micronesia, The Cross Radio/Pohnpei	4755 as	
0000 0100	New Zealand, Radio NZ International	15720pa	
0000 0100	New Zealand, Radio NZ International	17675pa	
0000 0100	Russia, Voice of Russia	7250va	
0000 0100	Spain, Radio Exterior de Espana	6055na	
0000 0100	Thailand, Radio Thailand World Svc	13745na	
0000 0100	UK, BBC World Service	6195as	9410as
	9740as	12095as	13725as
			15755as
0000 0100	USA, American Forces Network/AFRTS	4319usb	
	5446usb	5765usb	7812usb
	12759usb	13362usb	12133usb
0000 0100	USA, EWTN/WEWN Irondale, AL	11520me	
0000 0100	USA, FBN/WTJC Newport NC	9370na	
0000 0100	USA, WBCQ Monticello ME	5110am	
0000 0100	USA, WBCQ Monticello ME	9330am	
0000 0100	USA, WBCQ Monticello ME	7490am	
0000 0100	USA, WHRI Cypress Creek SC	7385ca	
0000 0100	USA, WINB Red Lion PA	9265ca	
0000 0100	USA, WTWW Lebanon TN	5755va	
0000 0100	USA, WWRB Nashville TN	3195eu	5070af
	9980af	13845eu	
0000 0100	USA, WWRB Manchester TN	3185va	3215na
	5050va	5745va	
0000 0100	USA, WYFR/Family Radio Worldwide	6155ca	
	7395ca		
0000 0100	Zambia, CVC Radio Christian Voice	4965af	
0030 0100	Australia, Radio Australia	15415va	
0030 0100	Canada, Bible Voice Broadcasting	7395as	
0030 0100	Palau, T8WH/ WHRI	15700as	
0030 0100	UK, BBC World Service	9510as	
0030 0100	USA, BBG/Voice of America	6170va	9325va
	9490va	9715va	11695va
	15185va	15205va	15290va
0030 0100	USA, BBG/Voice of America/Special English		
	6170va	9325va	9490va
	11695va	11730va	12005va
	15205va	15290va	15185va
0035 0045	India, All India Radio/Aizawl	5050do	
0035 0045	India, All India Radio/Chennai	4920do	
0035 0045	India, All India Radio/Guwahati	4940do	
0035 0045	India, All India Radio/Hyderabad	4800do	
0035 0045	India, All India Radio/Imphal	4775do	
0035 0045	India, All India Radio/Port Blair	4760do	
0035 0045	India, All India Radio/Shillong	4970do	
0035 0045	India, All India Radio/Shimla	4965do	
0035 0045	India, All India Radio/Thiruvananthapuram	5010do	

0100 UTC - 8PM EST / 7PM CST / 5PM PST

0100 0115 Sat	Canada, Bible Voice Broadcasting	7395as	
0100 0128	Vietnam, Voice of Vietnam/Overseas Svc	6175na	
0100 0156	Romania, Radio Romania International	6145na	
	7355na		
0100 0157	China, China Radio International	6005na	
	6020na	6075as	6175as
	9410eu	9420as	9570na
	11650as	11885as	9580na

0100 0157	North Korea, Voice of Korea	7220as	9345as
	9730as	11735ca	15180sa
0100 0200	Anguilla/Caribbean Beacon/Univ Network		
	6090na		
0100 0200	Australia, ABC NT Alice Springs		4835do
0100 0200	Australia, ABC NT Katherine		5025do
0100 0200	Australia, ABC NT Tennant Creek		4910do
0100 0200	Australia, Radio Australia	9660pa	12080va
	13690va	15240va	15415va
	17750va	17795va	17715va
0100 0200	Bahrain, Radio Bahrain	6010me	
0100 0200	Canada, CFRX Toronto ON	6070na	
0100 0200	Canada, CFVP Calgary AB	6030na	
0100 0200	Canada, CKZN St Johns NF	6160na	
0100 0200	Canada, CKZU Vancouver BC		6160na
0100 0200	Cuba, Radio Havana Cuba	6000na	6050na
0100 0200	Malaysia, RTM Kajang/Traxx FM		7295do
0100 0200	Micronesia, The Cross Radio/Pohnpei		4755 as
0100 0200	Mongolia, Mongolian Radio 2/Ulaanbaatar		7260do
0100 0200	New Zealand, Radio NZ International		15720pa
0100 0200	New Zealand, Radio NZ International		17675pa
0100 0200	Russia, Voice of Russia	7250va	
0100 0200	Taiwan, Radio Taiwan International		11875as
0100 0200	UK, BBC World Service	5940as	5970as
	9740as	11750as	12095as
	15335as	15755as	17685as
0100 0200	USA, American Forces Network/AFRTS	4319usb	
	5446usb	5765usb	7812usb
	12759usb	13362usb	12133usb
0100 0200	USA, BBG/Voice of America	9435as	11705pa
0100 0200	USA, EWTN/WEWN Irondale, AL		11520me
0100 0200	USA, FBN/WTJC Newport NC		9370na
0100 0200	USA, KJES Vado NM	7555na	
0100 0200	USA, WBCQ Monticello ME	7490am	
0100 0200	USA, WBCQ Monticello ME	9330am	
0100 0200	USA, WHRI Cypress Creek SC		5920na
0100 0200	USA, WINB Red Lion PA	9265ca	
0100 0200	USA, WTWW Lebanon TN	5755va	
0100 0200	USA, WWRB Nashville TN	3195eu	4840na
	5935af	9980af	
0100 0200	USA, WWRB Manchester TN	3185va	3215na
	5050va	5745va	
0100 0200	Zambia, CVC Radio Christian Voice	4965af	
0120 0200	Sri Lanka, SLBC	6005as	9770as
0130 0200	Iran, IRIB/ VOIRI	7230eu	7365eu
0130 0200	Palau, T8WH/ WHRI	15700as	
0130 0200	Serbia, International Radio Serbia		6190va
0130 0200	USA, BBG/Voice of America/Special English		
	5960va	7465va	
0130 0200	USA, WRMI/Radio Slovakia Intl relay		9955am

0200 UTC - 9PM EST / 8PM CST / 6PM PST

0200 0227	Iran, IRIB/ VOIRI	7230eu	7365eu
0200 0230	Thailand, Radio Thailand World Svc		15275na
0200 0230	USA, KJES Vado NM	7555na	
0200 0257	China, China Radio International		11785as
	13640as		
0200 0257	North Korea, Voice of Korea	13650as	15100as
0200 0300	Anguilla/Caribbean Beacon/Univ Network		
	6090na		
0200 0300	Argentina, RAE	11710am	
0200 0300	Australia, ABC NT Alice Springs		4835do
0200 0300	Australia, ABC NT Katherine		5025do
0200 0300	Australia, ABC NT Tennant Creek		4910do
0200 0300	Australia, Radio Australia	9660pa	12080va
	13690va	15240va	15415va
	17750va	17725as	15515pa
0200 0300	Bahrain, Radio Bahrain	6010me	
0200 0300	Canada, CFRX Toronto ON	6070na	
0200 0300	Canada, CFVP Calgary AB	6030na	
0200 0300	Canada, CKZN St Johns NF	6160na	
0200 0300	Canada, CKZU Vancouver BC		6160na
0200 0300	Cuba, Radio Havana Cuba	6000na	6050na
0200 0300	Egypt, Radio Cairo	9315na	
0200 0300	Indonesia, Voice of Indonesia	9526va	
0200 0300	Malaysia, RTM Kajang/Traxx FM		7295do
0200 0300	Micronesia, The Cross Radio/Pohnpei		4755 as
0200 0300	New Zealand, Radio NZ International		15720pa
0200 0300	New Zealand, Radio NZ International		17675pa
0200 0300	Palau, T8WH/ WHRI	17800as	
0200 0300	Philippines, PBS/ Radyo Pilipinas		11880me
	15285me	17700me	

0200	0300	Russia, Voice of Russia	7250sa	
0200	0300	South Korea, KBS World Radio	9580sa	
0200	0300	Sri Lanka, SLBC	6005as 15745as	
0200	0300	Taiwan, Radio Taiwan International	5950na	
		9680na		
0200	0300	UK, BBC World Service	5875me 5940as	
		7385af 12095as	15310as	
0200	0300	USA, American Forces Network/AFRTS	4319usb	
		5446usb 5765usb 7812usb	12133usb	
		12759usb 13362usb		
0200	0300	USA, EWTV/WEWN Irondale, AL	11520me	
0200	0300	USA, FBN/WTJC Newport NC	9370na	
0200	0300	USA, WBCQ Monticello ME	7490am	mtwhfa
0200	0300	USA, WBCQ Monticello ME	9330am	
0200	0300	USA, WHRI Cypress Creek SC	5920na	twhfa
		7385na		
0200	0300	USA, WINB Red Lion PA	9265ca	
0200	0300	USA, WRNO New Orleans LA	7505am	
0200	0300	USA, WTWW Lebanon TN	5755va	
0200	0300	USA, WWCR Nashville TN	3215eu 4840na	
		5890af 5935af		
0200	0300	USA, WWRB Manchester TN	3185va 5050va	
		5745va		
0200	0300	USA, WYFR/Family Radio Worldwide	5930ca	
		5985ca 6155ca		
0200	0300	Zambia, CVC Radio Christian Voice	4965af	
0215	0300	Nepal, Radio Nepal	5005as	
0230	0257	China, China Radio International	15435as	
0230	0258	Vietnam, Voice of Vietnam/Overseas Svc	6175ca	
0230	0300	Albania, Radio Tirana	7420na	twhfas
0230	0300	Myanmar, Myanma Radio/National Svc	5915do	
		5920al		
0245	0300	Australia, HCJB Global Australia	15400as	
0245	0300	India, All India Radio/Bhopal	7430do	
0245	0300	India, All India Radio/Delhi	4860do 6030do	
		7235do 11830do 15135do		
0245	0300	India, All India Radio/Gorakhpur	3945do	
		6030do 7235do 11830do	15135do	
0245	0300	India, All India Radio/Guwahati	4940do	
0245	0300	India, All India Radio/Hyderabad	7420do	
0245	0300	India, All India Radio/Imphal	7335do	
0245	0300	India, All India Radio/Itanagar	4990do	
0245	0300	India, All India Radio/Jaipur	4910do	
0245	0300	India, All India Radio/Kolkata	7210do	
0245	0300	India, All India Radio/Kurseong	4895do	
0245	0300	India, All India Radio/Lucknow	4880do	
0245	0300	India, All India Radio/Radio Kashmir	4760do	
0245	0300	India, All India Radio/Shillong	4970do	
0245	0300	India, All India Radio/Shimla	6020do	
0245	0300	India, All India Radio/Thiruvananthapuram	7290do	
0245	0300	Zambia, ZNBC/Radio Two	6165do	
0250	0300	Vatican City State, Vatican Radio	6040am	
		7305am		

0300 UTC - 10PM EST / 9PM CST / 7PM PST

0300	0315	Croatia, Voice of Croatia	3985am 7375am	
0300	0315	India, All India Radio/Imphal	7335do	
0300	0315	India, All India Radio/Itanagar	4990do	
0300	0315	India, All India Radio/Shillong	4970do	
0300	0330	Egypt, Radio Cairo	9315na	
0300	0330	Myanmar, Myanma Radio/National Svc	9731do	
0300	0330	Philippines, PBS/ Radyo Pilipinas	11880me	
		15285me 17700me		
0300	0330	Vatican City State, Vatican Radio	9660af	
		11625af		
0300	0355	South Africa, Channel Africa	6155af	
0300	0357	China, China Radio International	6190na	
		9460as 9690na 9790na	13620as	
		15120as		
0300	0357	North Korea, Voice of Korea	7220as 9345as	
		9730as		
0300	0359	South Africa, Channel Africa	3345af	
0300	0400	Anguilla/Caribbean Beacon/Univ Network	6090na	
0300	0400	Australia, ABC NT Alice Springs	4835do	
0300	0400	Australia, ABC NT Katherine	5025do	
0300	0400	Australia, ABC NT Tennant Creek	4910do	
0300	0400	Australia, Radio Australia	9660pa 12080va	
		13690va 15240va 15415va	15515pa	
		17750va 21725as		
0300	0400	Bahrain, Radio Bahrain	6010me	
0300	0400	Bulgaria, Radio Bulgaria	5900na 7400na	

0300	0400	twhfas	Canada, CBC Northern Quebec Svc	9625na
0300	0400		Canada, CFRX Toronto ON	6070na
0300	0400		Canada, CFPV Calgary AB	6030na
0300	0400		Canada, CKZN St Johns NF	6160na
0300	0400		Canada, CKZU Vancouver BC	6160na
0300	0400		Cuba, Radio Havana Cuba	6000na 6050na
0300	0400		Malaysia, RTM Kajang/Traxx FM	7295do
0300	0400		Micronesia, The Cross Radio/Pohnpei	4755 as
0300	0400		New Zealand, Radio NZ International	15720pa
0300	0400	DRM	New Zealand, Radio NZ International	17675pa
0300	0400		Oman, Radio Sultanate of Oman	15355af
0300	0400	Sun	Palau, T8WH/ WHRI	17800as
0300	0400	mtwhf	Palau, T8WH/ WHRI	17800as
0300	0400		Russia, Voice of Russia	7250sa 12040as
0300	0400	Sat	Sri Lanka, SLBC	6005as 9770as 15745as
0300	0400		Taiwan, Radio Taiwan International	6875na
			15320as	
0300	0400		UK, BBC World Service	3255af 5940me
			6145af 6190af 7255af	9410as
			9460af 11860af 12095as	15310as
			17790as	
0300	0400		USA, American Forces Network/AFRTS	4319usb
			5446usb 5765usb 7812usb	12133usb
			12759usb 13362usb	
0300	0400		USA, BBG/Voice of America	4930af 6080af
			9885af 15580af	
0300	0400		USA, EWTV/WEWN Irondale, AL	11520me
0300	0400		USA, FBN/WTJC Newport NC	9370na
0300	0400	mtwhfa	USA, WBCQ Monticello ME	7490am
0300	0400		USA, WBCQ Monticello ME	9330am
0300	0400	Sat	USA, WHRI Cypress Creek SC	7520va
0300	0400		USA, WINB Red Lion PA	9265ca
0300	0400		USA, WRNO New Orleans LA	7505am
0300	0400		USA, WTWW Lebanon TN	5755va
0300	0400		USA, WWCR Nashville TN	3215eu 4840na
			5890af 5935af	
0300	0400		USA, WWRB Manchester TN	3185va 5050va
			5745va	
0300	0400		USA, WYFR/Family Radio Worldwide	11740ca
0300	0400		Zambia, CVC Radio Christian Voice	4965af
0300	0400		Zambia, ZNBC/Radio Two	6165do
0330	0358		Vietnam, Voice of Vietnam/Overseas Svc	6175ca
0330	0400		Iran, IRIB/ VOIRI	7200eu 7365eu
0335	0345		India, All India Radio/Aizawl	5050do
0335	0345		India, All India Radio/Delhi	7235do 11830do
			15135do	
0335	0345		India, All India Radio/Kolkata	7210do

0400 UTC - 11PM EST / 10PM CST / 8PM PST

0400	0427		Iran, IRIB/ VOIRI	7200eu 7365eu
0400	0430		USA, BBG/Voice of America	4930af 4960af
			6080af 9885af	15580af
0400	0456		Romania, Radio Romania International	6130na
			7305na 11895as 15220as	
0400	0457		China, China Radio International	6190na
			9460as 13620as 15120as	17725as
			17855as	
0400	0457		Germany, Deutsche Welle	6180af 7350af
			9855af	
0400	0458		New Zealand, Radio NZ International	15720pa
0400	0458	DRM	New Zealand, Radio NZ International	17675pa
0400	0500		Anguilla/Caribbean Beacon/Univ Network	6090na
0400	0500		Australia, ABC NT Alice Springs	4835do
0400	0500		Australia, ABC NT Katherine	5025do
0400	0500		Australia, ABC NT Tennant Creek	4910do
0400	0500		Australia, Radio Australia	9660pa 12080va
			13690va 15240va 15515pa	17750va
			21725as	
0400	0500		Bahrain, Radio Bahrain	6010me
0400	0500	twhfas	Canada, CBC Northern Quebec Svc	9625na
0400	0500		Canada, CFRX Toronto ON	6070na
0400	0500		Canada, CKZN St Johns NF	6160na
0400	0500		Canada, CKZU Vancouver BC	6160na
0400	0500		Cuba, Radio Havana Cuba	6000na 6050na
0400	0500	mtwhf	France, Radio France Internationale	9805af
			11995af	
0400	0500		Malaysia, RTM Kajang/Traxx FM	7295do
0400	0500		Micronesia, The Cross Radio/Pohnpei	4755 as
0400	0500		Russia, Voice of Russia	12040as
0400	0500		South Africa, Channel Africa	7230af
0400	0500	Sat	Sri Lanka, SLBC	6005as 9770as 15745as
0400	0500		Turkey, Voice of Turkey	7240as 9655va

0400	0500	UK, BBC World Service	3255af	6005af
		6190af	7255af	9410me
		12035af	12095af	15310as
		17790as		15360as
0400	0500	USA, American Forces Network/AFRTS	4319usb	
		5446usb	5765usb	7812usb
		12759usb	13362usb	
0400	0500	USA, EWTN/WEWN Irondale, AL	11520me	
0400	0500	USA, FBN/WTJC Newport NC	9370na	
0400	0500	mtwhfa USA, WBCQ Monticello ME	7490am	
0400	0500	USA, WBCQ Monticello ME	9330am	
0400	0500	m USA, WBCQ Monticello ME	5110am	
0400	0500	hf USA, WHRI Cypress Creek SC	7385na	
0400	0500	Sun USA, WHRI Cypress Creek SC	7465eu	
0400	0500	Sat USA, WHRI Cypress Creek SC	9640me	
0400	0500	USA, WRNO New Orleans LA	7505am	
0400	0500	USA, WTWW Lebanon TN	5755va	
0400	0500	USA, WWCR Nashville TN	3215eu	4840na
		5890af	5935af	
0400	0500	USA, WWRB Manchester TN	3185va	5050va
		5745va		
0400	0500	Zambia, CVC Radio Christian Voice	4965af	
0400	0500	Zambia, ZNBC/Radio Two	6165do	
0430	0500	Australia, Radio Australia	15415va	
0430	0500	Sun Palau, T8WH/ WHRI	17800as	
0430	0500	USA, BBG/Voice of America	4930af	4960af
		9885af	15580af	
0435	0445	India, All India Radio/Delhi	4860do	
0455	0500	Nigeria, Voice of Nigeria	15120af	
0459	0500	New Zealand, Radio NZ International	11725pa	
0459	0500	DRM New Zealand, Radio NZ International	13730pa	

0500 UTC - 12AM EST / 11PM CST / 9PM PST

0500	0507	twhf	Canada, CBC Northern Quebec Svc	9625na
0500	0530		Germany, Deutsche Welle	6155af
			12045af	
0500	0530		Japan, Radio Japan NHK World	5975va
			6110na	9770va
0500	0557		China, China Radio International	5960na
			6190na	7220af
			11880as	15350as
			17725as	17855as
0500	0600		Anguilla/Caribbean Beacon/Univ Network	6090na
0500	0600		Australia, ABC NT Alice Springs	4835do
0500	0600		Australia, ABC NT Katherine	5025do
0500	0600		Australia, ABC NT Tennant Creek	4910do
0500	0600		Australia, Radio Australia	9660pa
			13630va	13690va
			17750va	21725va
0500	0600		Bahrain, Radio Bahrain	6010me
0500	0600		Bhutan, Bhutan Broadcasting Svc	6035do
0500	0600		Canada, CFRX Toronto ON	6070na
0500	0600		Canada, CKZN St Johns NF	6160na
0500	0600		Canada, CKZU Vancouver BC	6160na
0500	0600		Cuba, Radio Havana Cuba	6010na
			6060ca	6125ca
0500	0600	mtwhf	Equatorial Guinea, Radio Africa 2	15190af
0500	0600	Sat/Sun	Equatorial Guinea, Radio East Africa	15190af
0500	0600	mtwhf	France, Radio France Internationale	11995af
			13680af	
0500	0600		Malaysia, RTM Kajang/Traxx FM	7295do
0500	0600		Micronesia, The Cross Radio/Pohnpei	4755 as
0500	0600		New Zealand, Radio NZ International	11725pa
0500	0600	DRM	New Zealand, Radio NZ International	13730pa
0500	0600		Nigeria, Voice of Nigeria	15120af
0500	0600		South Africa, Channel Africa	7230af
0500	0600		Swaziland, TWR Africa	6120af
0500	0600		Taiwan, Radio Taiwan International	6875na
0500	0600		UK, BBC World Service	3255af
			6005af	6190af
			12095af	15310as
			15420af	17640af
			17790as	
0500	0600	Sat/Sun	UK, BBC World Service	15420af
0500	0600		USA, American Forces Network/AFRTS	4319usb
			5446usb	5765usb
			12759usb	13362usb
0500	0600		USA, BBG/Voice of America	4930af
			9885af	15580af
0500	0600		USA, EWTN/WEWN Irondale, AL	11520me
0500	0600		USA, FBN/WTJC Newport NC	9370na
0500	0600		USA, WBCQ Monticello ME	9330am
0500	0600	Sun	USA, WHRI Cypress Creek SC	11565pa

0500	0600		USA, WTWW Lebanon TN	5755va	12100va
0500	0600		USA, WWCR Nashville TN	3215eu	4840na
			5890af	5935af	
0500	0600		USA, WWRB Manchester TN	3185va	5050va
			5745va		
0500	0600		Zambia, CVC Radio Christian Voice	6065af	
0500	0600		Zambia, ZNBC/Radio Two	6165do	
0530	0600		Australia, Radio Australia	15415va	
0530	0600	Sat/Sun	Clandestine, Sudan Radio Service/SRS	13720af	
0530	0600	Sun	Palau, T8WH/ WHRI	17800as	
0530	0600		Thailand, Radio Thailand World Svc	12015eu	

0600 UTC - 1AM EST / 12AM CST / 10PM PST

0600	0630		Australia, Radio Australia	15290as	
0600	0630		Germany, Deutsche Welle	12045af	15440af
			17800af		
0600	0630		Vatican City State, Vatican Radio	3975eu	
			6075eu	7250eu	
0600	0650	DRM	New Zealand, Radio NZ International	13730pa	
0600	0655		South Africa, Channel Africa	15255af	
0600	0657		China, China Radio International	6115na	
			11750af	11770as	11880as
			15145as	15350as	15465as
			17540as	17710as	17505va
0600	0659		South Africa, Channel Africa	7230af	
0600	0700		Anguilla/Caribbean Beacon/Univ Network	6090na	
0600	0700		Australia, ABC NT Alice Springs	4835do	
0600	0700		Australia, ABC NT Katherine	5025do	
0600	0700		Australia, ABC NT Tennant Creek	4910do	
0600	0700		Australia, Radio Australia	9660pa	12080va
			13630va	13690va	15160va
			15415va	17750va	21725va
0600	0700		Bahrain, Radio Bahrain	6010me	
0600	0700		Canada, CFRX Toronto ON	6070na	
0600	0700		Canada, CFVP Calgary AB	6030na	
0600	0700		Canada, CKZN St Johns NF	6160na	
0600	0700		Canada, CKZU Vancouver BC	6160na	6160na
0600	0700		Cuba, Radio Havana Cuba	6010na	6050na
			6060ca	6125ca	
0600	0700	mtwhf	Equatorial Guinea, Radio Africa 2	15190af	
0600	0700	Sat/Sun	Equatorial Guinea, Radio East Africa	15190af	
0600	0700	mtwhf	France, Radio France Internationale	11615va	
			15160af	17800af	
0600	0700		Malaysia, RTM Kajang/Traxx FM	7295do	
0600	0700		Malaysia, RTM/Voice of Malaysia	6175as	
			9750as	15295as	
0600	0700		Micronesia, The Cross Radio/Pohnpei	4755 as	
0600	0700		New Zealand, Radio NZ International	11725pa	
0600	0700		Nigeria, Voice of Nigeria	15120af	
0600	0700	Sun	Palau, T8WH/ WHRI	17800as	
0600	0700		Papua New Guinea, Radio Fly	5960do	
0600	0700		Russia, Voice of Russia	17805pa	21805pa
0600	0700	DRM	Russia, Voice of Russia	11635eu	
0600	0700		South Africa, CVC 1 Africa Radio	13590af	
0600	0700		Swaziland, TWR Africa	6120af	
0600	0700		UK, BBC World Service	3955eu	6005af
			6190af	9410af	11760me
			12095af	15310as	15400af
			17640af	17790as	
0600	0700		USA, American Forces Network/AFRTS	4319usb	
			5446usb	5765usb	7812usb
			12759usb	13362usb	
0600	0700		USA, BBG/Voice of America	6080af	9885af
			15580af		
0600	0700		USA, EWTN/WEWN Irondale, AL	11520af	
0600	0700		USA, FBN/WTJC Newport NC	9370na	
0600	0700		USA, WBCQ Monticello ME	9330am	
0600	0700	Sat	USA, WHRI Cypress Creek SC	9615me	
0600	0700		USA, WTWW Lebanon TN	5755va	12100va
0600	0700		USA, WWCR Nashville TN	3215eu	4840na
			5890af	5935af	
0600	0700		USA, WWRB Manchester TN	3185va	5050va
			5745va		
0600	0700		Zambia, CVC Radio Christian Voice	6065af	
			17695af		
0600	0700		Zambia, ZNBC/Radio Two	6165do	
0630	0645		India, All India Radio/Guwahati	7280do	
0630	0645		India, All India Radio/Hyderabad	7420do	
0630	0645		India, All India Radio/Kurseong	7230do	
0630	0645		India, All India Radio/Mumbai	7240do	
0630	0645		India, All India Radio/Thiruvananthapuram	7290do	

0630	0656	DRM	Romania, Radio Romania International	9600eu
0630	0656		Romania, Radio Romania International	7310eu
			17780eu	21600eu
0630	0700		Vatican City State, Vatican Radio	7360af
			9660af	11625af
0651	0700	DRM	New Zealand, Radio NZ International	13730pa

0700 UTC - 2AM EST / 1AM CST / 11PM PST

0700	0757		China, China Radio International	11785eu
			11880as	13645as
			15465as	17540as
			17490eu	17710as
0700	0758		New Zealand, Radio NZ International	11725pa
0700	0758	DRM	New Zealand, Radio NZ International	13730pa
0700	0800		Anguilla/Caribbean Beacon/Univ Network	6090na
0700	0800		Australia, ABC NT Alice Springs	4835do
0700	0800		Australia, ABC NT Katherine	5025do
0700	0800		Australia, ABC NT Tennant Creek	4910do
0700	0800		Australia, Radio Australia	9475as
			9710as	11945as
			12080va	13630va
			15160va	15240va
0700	0800		Bahrain, Radio Bahrain	6010me
0700	0800	m/DRM	Belgium, TDP Radio	6015eu
0700	0800		Canada, CFRX Toronto ON	6070na
0700	0800		Canada, CFVP Calgary AB	6030na
0700	0800		Canada, CKZN St Johns NF	6160na
0700	0800		Canada, CKZU Vancouver BC	6160na
0700	0800	mtwhf	Equatorial Guinea, Radio Africa 2	15190af
0700	0800	Sat/Sun	Equatorial Guinea, Radio East Africa	15190af
0700	0800	mtwhf	France, Radio France Internationale	15615af
			17605af	
0700	0800		Malaysia, RTM Kajang/Traxx FM	7295do
0700	0800		Malaysia, RTM/Voice of Malaysia	6175as
			9750as	15295as
0700	0800		Micronesia, The Cross Radio/Pohnpei	4755 as
0700	0800		Papua New Guinea, Radio Fly	5960do
0700	0800		Russia, Voice of Russia	17805va
0700	0800	DRM	Russia, Voice of Russia	11635eu
0700	0800		South Africa, CVC 1 Africa Radio	13590af
0700	0800		Swaziland, TWR Africa	6120af
0700	0800		UK, BBC World Service	3955eu
			6190af	11760me
			13820af	15310as
			17640af	17790as
			17830af	
0700	0800		USA, American Forces Network/AFRTS	4319usb
			5446usb	5765usb
			7812usb	12133usb
			12759usb	13362usb
0700	0800		USA, EWTV/WEWN Irondale, AL	11520af
0700	0800		USA, FBN/WTJC Newport NC	9370na
0700	0800		USA, WBCQ Monticello ME	9330am
0700	0800	Sun	USA, WHRI Cypress Creek SC	11565pa
0700	0800		USA, WTWW Lebanon TN	5755va
0700	0800		USA, WWCR Nashville TN	3215eu
			5890af	5935af
0700	0800		USA, WWRB Manchester TN	3185va
0700	0800		Zambia, CVC Radio Christian Voice	6065af
			17695af	
0700	0800		Zambia, ZNBC/Radio Two	6165do
0730	0745		India, All India Radio/Aizawl	5050do
0730	0745		India, All India Radio/Delhi	6190do
			15185do	15260do
0730	0745		India, All India Radio/Guwahati	7280do
0730	0745		India, All India Radio/Imphal	7335do
0730	0745		India, All India Radio/Jaipur	7325do
0730	0745		India, All India Radio/Kolkata	7210do
0730	0745		India, All India Radio/Kurseong	7230do
0730	0745		India, All India Radio/Shimla	6020do
0730	0800		Australia, HCJB Global Australia	11750pa
0730	0800		Bulgaria, Radio Bulgaria	7400eu
0730	0800		India, All India Radio/Chennai	4920do
0745	0800		Saudi Arabia, BSKSA/External Svc	17785af
0759	0800		New Zealand, Radio NZ International	9765pa
0759	0800	DRM	New Zealand, Radio NZ International	9870pa

0800 UTC - 3AM EST / 2AM CST / 12AM PST

0800	0830		Australia, ABC NT Alice Springs	4835do
0800	0830		Australia, ABC NT Katherine	5025do
0800	0830		Australia, ABC NT Tennant Creek	4910do
0800	0830		Australia, HCJB Global Australia	11750pa
0800	0830	Sun	Canada, Bible Voice Broadcasting	7250eu
0800	0845	Sat	Canada, Bible Voice Broadcasting	7220eu

0800	0850		Austria, TWR Europe	7310eu
0800	0850		Germany, TWR Europe	6105eu
0800	0857		China, China Radio International	9415as
			11785eu	11880eu
			13350as	15465as
			15625va	17490eu
			17540as	
0800	0900		Anguilla/Caribbean Beacon/Univ Network	6090na
0800	0900		Australia, Radio Australia	5995va
			9580pa	9590pa
			12080va	13630va
0800	0900		Bahrain, Radio Bahrain	6010me
0800	0900	t/DRM	Belgium, TDP Radio	6015eu
0800	0900		Bhutan, Bhutan Broadcasting Svc	6035do
0800	0900		Canada, CFRX Toronto ON	6070na
0800	0900		Canada, CFVP Calgary AB	6030na
0800	0900		Canada, CKZN St Johns NF	6160na
0800	0900		Canada, CKZU Vancouver BC	6160na
0800	0900	mtwhf	Equatorial Guinea, Radio Africa 2	15190af
0800	0900	Sat/Sun	Equatorial Guinea, Radio East Africa	15190af
0800	0900		Malaysia, RTM Kajang/Traxx FM	7295do
0800	0900		Malaysia, RTM/Voice of Malaysia	6175as
			9750as	15295as
0800	0900		Micronesia, The Cross Radio/Pohnpei	4755 as
0800	0900		New Zealand, Radio NZ International	9765pa
0800	0900	DRM	New Zealand, Radio NZ International	9870pa
0800	0900	mtwhf	Palau, T8WH/ WHRI	9930as
0800	0900	Sun	Palau, T8WH/ WHRI	9930as
0800	0900		Papua New Guinea, Radio Fly	5960do
0800	0900		Russia, Voice of Russia	17805va
0800	0900	DRM	Russia, Voice of Russia	7325eu
0800	0900		Saudi Arabia, BSKSA/External Svc	17785af
0800	0900		South Africa, Channel Africa	9625af
0800	0900		South Africa, CVC 1 Africa Radio	13590af
0800	0900	Sun	South Africa, South African Radio League	7205af
			17760af	
0800	0900		South Korea, KBS World Radio	9570as
0800	0900		UK, BBC World Service	5760eu
			6190af	11760me
			12095af	15310as
			15400af	15575me
			17640af	17790as
			17830af	21470af
0800	0900		USA, American Forces Network/AFRTS	4319usb
			5446usb	5765usb
			7812usb	12133usb
			12759usb	13362usb
0800	0900		USA, EWTV/WEWN Irondale, AL	11520af
0800	0900		USA, FBN/WTJC Newport NC	9370na
0800	0900		USA, WBCQ Monticello ME	9330am
0800	0900	smtwhf	USA, WHRI Cypress Creek SC	11565pa
0800	0900		USA, WTWW Lebanon TN	5755va
0800	0900		USA, WWCR Nashville TN	3215eu
			5890af	5935af
0800	0900		USA, WWRB Manchester TN	3185va
0800	0900		Zambia, CVC Radio Christian Voice	6065af
			17695af	
0800	0900		Zambia, ZNBC/Radio Two	6165do
0815	0900		Nepal, Radio Nepal	5005as
0820	0900	smtwhf	Guam, TWR Asia/KTWR	15170as
0830	0845		India, All India Radio/Aizawl	5050do
0830	0845		India, All India Radio/Chennai	4920do
0830	0845		India, All India Radio/Delhi	6190do
			15185do	15260do
0830	0845		India, All India Radio/Hyderabad	7420do
0830	0845		India, All India Radio/Imphal	7335do
0830	0845		India, All India Radio/Itanagar	4990do
0830	0845		India, All India Radio/Kolkata	7210do
0830	0845		India, All India Radio/Shillong	7315do
0830	0845		India, All India Radio/Thiruvananthapuram	7290do
0830	0900		Australia, ABC NT Alice Springs	2310do
0830	0900		Australia, ABC NT Katherine	2485do
0830	0900		Australia, ABC NT Tennant Creek	2325do
0830	0900	mtwhfa	Guam, TWR Asia/KTWR	11840pa

0900 UTC - 4AM EST / 3AM CST / 1AM PST

0900	0910	mtwhfa	Guam, TWR Asia/KTWR	11840as
0900	0930	Sat/Sun/DRM	Bulgaria, BNR Horizont/Home Svc 1	11900eu
0900	0930	mtwhf	Palau, T8WH/ WHRI	9930as
0900	0930	Sun	Palau, T8WH/ WHRI	9930as
0900	0957		China, China Radio International	9415as
			15210pa	15270eu
			17570eu	15350as
			17690pa	17750as
0900	1000		Anguilla/Caribbean Beacon/Univ Network	6090na

0900 1000		Australia, ABC NT Alice Springs	2310do
0900 1000		Australia, ABC NT Katherine	2485do
0900 1000		Australia, ABC NT Tennant Creek	2325do
0900 1000		Australia, Radio Australia	9475as 9580pa
		9590pa 11945as	12080va
0900 1000		Bahrain, Radio Bahrain	6010me
0900 1000	w/DRM	Belgium, TDP Radio	6015eu
0900 1000		Canada, CFRX Toronto ON	6070na
0900 1000		Canada, CFVP Calgary AB	6030na
0900 1000		Canada, CKZN St Johns NF	6160na
0900 1000		Canada, CKZU Vancouver BC	6160na
0900 1000	3rd Sun	Germany, XVRB Radio	6045va
0900 1000	Sat	Italy, IRRS-Shortwave	9510va
0900 1000		Malaysia, RTM Kajang/Traxx FM	7295do
0900 1000		Malaysia, RTM/Voice of Malaysia	6175as
		9750as 15295as	
0900 1000		Micronesia, The Cross Radio/Pohnpei	4755 as
0900 1000	DRM	New Zealand, Radio NZ International	9870pa
0900 1000		New Zealand, Radio NZ International	9765pa
0900 1000		Nigeria, Voice of Nigeria	9690af
0900 1000	Sat	Palau, T8WH/ WHRI	9930as
0900 1000		Papua New Guinea, Radio Fly	15700as
0900 1000		Russia, Voice of Russia	7205as 17805va
		21805va	
0900 1000	DRM	Russia, Voice of Russia	7325eu 11635eu
0900 1000		South Africa, Channel Africa	9625af
0900 1000		South Africa, CVC 1 Africa Radio	13590af
0900 1000		UK, BBC World Service	6190af 6195as
		9740as 11760me 11895as	12095af
		15285as 15310as 15400af	15575me
		17760as 17790as	17830af 21470af
0900 1000		USA, American Forces Network/AFRTS	4319usb
		5446usb 5765usb 7812usb	12133usb
		12759usb 13362usb	
0900 1000		USA, EWTN/WEWN Irontdale, AL	9390as
0900 1000		USA, FBN/WTJC Newport NC	9370na
0900 1000		USA, WBCQ Monticello ME	9330am
0900 1000	Sun	USA, WHRI Cypress Creek SC	11565pa
0900 1000		USA, WTWW Lebanon TN	5755va 12100va
0900 1000		USA, WWCR Nashville TN	3215eu 4890na
		5890af 5935af	
0900 1000		USA, WWRB Manchester TN	3185va
0900 1000		USA, WYFR/Family Radio Worldwide	9465as
0900 1000		Zambia, CVC Radio Christian Voice	6065af
		17695af	
0900 1000		Zambia, ZNBC/Radio Two	6165do
0905 0910		Pakistan, PBC/Radio Pakistan	15725eu 17700eu
0915 0930	mtwhf	Palau, T8WH/ WHRI	9930as
0930 1000	w	Palau, T8WH/ WHRI	9930as
0945 1000	m	Palau, T8WH/ WHRI	9930as
0945 1000	hf	Palau, T8WH/ WHRI	9930as
0945 1000	mtwhf	Palau, T8WH/ WHRI	15700as

1000 UTC - 5AM EST / 4AM CST / 2AM PST

1000 1030		Japan, Radio Japan NHK World	9605as
		9625pa 9840pa	
1000 1030		Vietnam, Voice of Vietnam/Overseas Svc	9840as
		12020as	
1000 1057		China, China Radio International	5955as
		7215as 11640as 13590as	13720as
		15190as 15210pa 15350as	17490eu
		17690as	
1000 1057		Netherlands, R Netherlands Worldwide	12065as
1000 1057		North Korea, Voice of Korea	11710ca 11735as
		13650as 15180sa	
1000 1058		New Zealand, Radio NZ International	9765pa
1000 1100		Anguilla/Caribbean Beacon/Univ Network	11775na
1000 1100		Australia, ABC NT Alice Springs	2310do
1000 1100		Australia, ABC NT Katherine	2485do
1000 1100		Australia, ABC NT Tennant Creek	2325do
1000 1100		Australia, Radio Australia	9580pa 9590pa
		11945as 12080va	
1000 1100		Bahrain, Radio Bahrain	6010me
1000 1100	h/DRM	Belgium, TDP Radio	6015eu
1000 1100		Canada, CFRX Toronto ON	6070na
1000 1100		Canada, CFVP Calgary AB	6030na
1000 1100		Canada, CKZN St Johns NF	6160na
1000 1100		Canada, CKZU Vancouver BC	6160na
1000 1100		India, All India Radio/External Svc	7270as
		13695pa 15260as 15410as	17510pa
		17800as 17895pa	
1000 1100		Indonesia, Voice of Indonesia	9526va
1000 1100		Malaysia, RTM Kajang/Traxx FM	7295do
1000 1100		Micronesia, The Cross Radio/Pohnpei	4755as

1000 1100	DRM	New Zealand, Radio NZ International	9870pa
1000 1100		Nigeria, Voice of Nigeria	9690af
1000 1100	fa	Palau, T8WH/ WHRI	9930as
1000 1100		Russia, Voice of Russia	7205as
1000 1100		Saudi Arabia, BSKSA/External Svc	15250af
1000 1100		South Africa, Channel Africa	9625af
1000 1100		South Africa, CVC 1 Africa Radio	13590af
1000 1100		UK, BBC World Service	6190af 6195as
		9740as 11760me 11895as	12095af
		15285as 15310as 15575me	17640af
		17760as 17790as	21470af
1000 1100	Sat/Sun	UK, BBC World Service	15400af 17830af
1000 1100		USA, American Forces Network/AFRTS	4319usb
		5446usb 5765usb 7812usb	12133usb
		12759usb 13362usb	
1000 1100		USA, EWTN/WEWN Irontdale, AL	9390as
1000 1100		USA, FBN/WTJC Newport NC	9370na
1000 1100		USA, KNLS Anchor Point AK	9615as
1000 1100		USA, WBCQ Monticello ME	9330am
1000 1100	Sun	USA, WHRI Cypress Creek SC	11565pa
1000 1100		USA, WTWW Lebanon TN	5755va 12100va
1000 1100		USA, WWCR Nashville TN	4840na 5890af
		5935af 7465eu	
1000 1100		USA, WWRB Manchester TN	3185va
1000 1100		USA, WYFR/Family Radio Worldwide	9465as
1000 1100		Zambia, CVC Radio Christian Voice	6065af
		17695af	
1000 1100		Zambia, ZNBC/Radio Two	6165do
1015 1100	Sun	Palau, T8WH/ WHRI	9930as
1030 1030	mtwhfa	USA, WRMI/Radio Prague relay	9955am
1030 1100		Iran, IRIB/ VOIRI	21695va
1030 1100	Sun	Italy, IRRS-Shortwave	9510va
1030 1100	Sun	Italy, IRRS-Shortwave/Euro Gospel Radio	9510eu
1030 1100		Mongolia, Voice of Mongolia	12085as
1030 1100	mtwhf	Palau, T8WH/ WHRI	9930as
1059 1100		New Zealand, Radio NZ International	15720pa

1100 UTC - 6AM EST / 5AM CST / 3AM PST

1100 1105		Pakistan, PBC/Radio Pakistan	15725eu 17700eu
1100 1127		Iran, IRIB/ VOIRI	21695va 21695va
1100 1130	f/ DRM	Japan, Radio Japan NHK World	9760eu
1100 1130	Sat/DRM	South Korea, KBS World Radio	9760eu
1100 1130		UK, BBC World Service	15400af
1100 1130		Vietnam, Voice of Vietnam/Overseas Svc	7285as
1100 1157		China, China Radio International	5955as
		5960na 9570as 11650as	11795as
		13645as 13665eu 13590as	13720as
		15110as 17490eu	
1100 1158	DRM	New Zealand, Radio NZ International	9870pa
1100 1200		Anguilla/Caribbean Beacon/Univ Network	11775na
1100 1200		Australia, ABC NT Alice Springs	2310do
1100 1200		Australia, ABC NT Katherine	2485do
1100 1200		Australia, ABC NT Tennant Creek	2325do
1100 1200		Australia, Radio Australia	5995va 6020va
		6140as 9475as 9560as	9580pa
		9590pa 11945as	
1100 1200	DRM	Australia, Radio Australia	12080pa
1100 1200		Bahrain, Radio Bahrain	6010me
1100 1200	f/DRM	Belgium, TDP Radio	6015eu
1100 1200	Sat/Sun	Canada, CBC Northern Quebec Svc	9625na
1100 1200		Canada, CFRX Toronto ON	6070na
1100 1200		Canada, CFVP Calgary AB	6030na
1100 1200		Canada, CKZN St Johns NF	6160na
1100 1200		Canada, CKZU Vancouver BC	6160na
1100 1200	Sun	Italy, IRRS-Shortwave	9510va
1100 1200	Sun	Italy, IRRS-Shortwave/Euro Gospel Radio	9510eu
1100 1200		Malaysia, RTM Kajang/Traxx FM	7295do
1100 1200		New Zealand, Radio NZ International	15720pa
1100 1200		Nigeria, Voice of Nigeria	9690af
1100 1200	DRM	Russia, Voice of Russia	12000as
1100 1200		Russia, Voice of Russia	7205as 7260as
		7350as 9560as 9670as	
1100 1200		Saudi Arabia, BSKSA/External Svc	15250af
1100 1200		South Africa, Channel Africa	9625af
1100 1200		South Africa, CVC 1 Africa Radio	13590af
1100 1200		Taiwan, Radio Taiwan International	7445as
		11715as	
1100 1200		UK, BBC World Service	6190af 6195as
		9740as 11760me 11895as	12095af
		15285as 15575me 17640af	17790as
		17830as 21470af	
1100 1200		USA, American Forces Network/AFRTS	4319usb
		5446usb 5765usb 7812usb	12133usb
		12759usb 13362usb	

1100	1200	USA, EWTVN/WEWN Irondale, AL	9390as
1100	1200	USA, FBN/WTJC Newport NC	9370na
1100	1200	USA, WBCQ Monticello ME	9330am
1100	1200	Sat/Sun USA, WHRI Cypress Creek SC	7315ca
1100	1200	USA, WTWW Lebanon TN	5755va 12100va
1100	1200	USA, WWCR Nashville TN	4840na 5890af
		5935af 7465eu	
1100	1200	USA, WWRB Manchester TN	3185va
1100	1200	USA, WYFR/Family Radio Worldwide	9310as
		13795as	
1100	1200	Zambia, CVC Radio Christian Voice	6065af
		17695af	
1100	1200	Zambia, ZNBC/Radio Two	6165do
1130	1200	f Vatican City State, Vatican Radio	15595as
		17590as	
1130	1200	Vietnam, Voice of Vietnam/Overseas Svc	9840as
		12020as	
1135	1145	India, All India Radio/Aizawl	5050do
1135	1145	India, All India Radio/Delhi	9595do 11710do
		15185do	
1135	1145	India, All India Radio/Shillong	4970do

1200 UTC - 7AM EST / 6AM CST / 4AM PST

1200	1230	Germany, AWR Europe	17510as
1200	1230	Japan, Radio Japan NHK World	6120na
		9695as	
1200	1230	Saudi Arabia, BSKSA/External Svc	15250af
1200	1256	Romania, Radio Romania International	15430eu
		15460eu 17530af 17765af	
1200	1257	China, China Radio International	5955as
		7250as 9460as 9660as 9645as	
		9730as 9760 oa 11650as	
		11690as 11760pa 12015as 13665eu	
		13790eu 13980as 17490eu	
1200	1258	New Zealand, Radio NZ International	15720pa
1200	1300	Anguilla/Caribbean Beacon/Univ Network	11775na
1200	1300	Australia, ABC NT Alice Springs	2310do
1200	1300	Australia, ABC NT Katherine	2485do
1200	1300	Australia, ABC NT Tennant Creek	2325do
1200	1300	Australia, Radio Australia	6020va 6140as
		9475as 9560as 9580pa 9590pa	
1200	1300	DRM Australia, Radio Australia	5995va
1200	1300	Bahrain, Radio Bahrain	6010me
1200	1300	Sat/ DRM Belgium, TDP Radio	6015eu
1200	1300	Sat/Sun Canada, CBC Northern Quebec Svc	9625na
1200	1300	Canada, CFRX Toronto ON	6070na
1200	1300	Canada, CFVP Calgary AB	6030na
1200	1300	Canada, CKZN St Johns NF	6160na
1200	1300	Canada, CKZU Vancouver BC	6160na
1200	1300	Ethiopia, Radio Ethiopia/National Program	5990do 7110do 9705do
1200	1300	Sun Italy, IRRS-Shortwave/Euro Gospel Radio	9510eu
1200	1300	Malaysia, RTM Kajang/Traxx FM	7295do
1200	1300	Nigeria, Voice of Nigeria	9690af
1200	1300	Sat/Sun Palau, T8WH/ WHRI	9930as
1200	1300	DRM Russia, Voice of Russia	7325eu 7340as
		12000as	
1200	1300	Russia, Voice of Russia	7350as 9560as
		11660as	
1200	1300	South Africa, CVC 1 Africa Radio	13590af
1200	1300	South Korea, KBS World Radio	9650na
1200	1300	UK, BBC World Service	5875as 6190af
		6195as 9740as 11760me 11895as	
		15310as 15575me 17640af 17830as	
1200	1300	USA, American Forces Network/AFRTS	4319usb
		5446usb 5765usb 7812usb 12133usb	
		12759usb 13362usb	
1200	1300	USA, BBG/Voice of America	7575as 9640as
		11700pa 11750pa 12150va	
1200	1300	USA, EWTVN/WEWN Irondale, AL	14610eu
1200	1300	USA, FBN/WTJC Newport NC	9370na
1200	1300	USA, KNLS Anchor Point AK	9615as
1200	1300	USA, WBCQ Monticello ME	9330am
1200	1300	smtwhf USA, WHRI Cypress Creek SC	7385na
1200	1300	USA, WTWW Lebanon TN	5755va 12100va
1200	1300	USA, WWCR Nashville TN	4890na 5935af
		9980af 15825eu	
1200	1300	USA, WWRB Manchester TN	9395na
1200	1300	USA, WYFR/Family Radio Worldwide	9310as
		17520as 17880as	
1200	1300	Zambia, CVC Radio Christian Voice	6065af
		17695af	

1200	1300	Zambia, ZNBC/Radio Two	6165do
1215	1300	Egypt, Radio Cairo	17870as
1230	1245	India, All India Radio/Aizawl	5050do
1230	1245	India, All India Radio/Chennai	4920do
1230	1245	India, All India Radio/Delhi	4860do 6085do
1230	1245	India, All India Radio/Hyderabad	4800do
1230	1245	India, All India Radio/Jeyapore	5040do
1230	1245	India, All India Radio/Kurseong	4895do
1230	1245	India, All India Radio/Port Blair	4760do
1230	1245	India, All India Radio/Radio Kashmir	4950do
1230	1245	India, All India Radio/Shillong	4970do
1230	1245	India, All India Radio/Thiruvananthapuram	5010do
1230	1300	Thailand, Radio Thailand World Svc	9720va
1230	1300	Vietnam, Voice of Vietnam/Overseas Svc	9840as
		12020as	

1300 UTC - 8AM EST / 7AM CST / 5AM PST

1300	1330	Egypt, Radio Cairo	17870as
1300	1330	Japan, Radio Japan NHK World	11730as
1300	1357	China, China Radio International	5995as
		7300as 9570na 9655as 9730as	
		9765as 9870as 11760pa 11885na	
		11900pa 11980as 13670eu 13790eu	
		15230na	
1300	1357	North Korea, Voice of Korea	9335na 11710na
		13760eu 15245eu	
1300	1400	Anguilla/Caribbean Beacon/Univ Network	11775na
1300	1400	Australia, ABC NT Alice Springs	2310do
1300	1400	Australia, ABC NT Katherine	2485do
1300	1400	DRM Australia, Radio Australia	5995va
1300	1400	Bahrain, Radio Bahrain	6010me
1300	1400	Sun/DRM Belgium, TDP Radio	6015na
1300	1400	Sat/Sun Canada, CBC Northern Quebec Svc	9625na
1300	1400	Canada, CFRX Toronto ON	6070na
1300	1400	Canada, CFVP Calgary AB	6030na
1300	1400	Canada, CKZN St Johns NF	6160na
1300	1400	Canada, CKZU Vancouver BC	6160na
1300	1400	Indonesia, Voice of Indonesia	9526as
1300	1400	Italy, IRRS-Shortwave	15190va
1300	1400	Italy, IRRS-Shortwave/Overcomer Ministry	15190pa
1300	1400	Malaysia, RTM Kajang/Traxx FM	7295do
1300	1400	New Zealand, Radio NZ International	5950pa
1300	1400	Nigeria, Voice of Nigeria	9690af
1300	1400	Sat/Sun Palau, T8WH/ WHRI	9930as
1300	1400	DRM Russia, Voice of Russia	7325eu 7340as
		9675eu	
1300	1400	Russia, Voice of Russia	7205as 7260as
		9560as	
1300	1400	South Africa, CVC 1 Africa Radio	13590af
1300	1400	South Korea, KBS World Radio	9570as
1300	1400	Tajikistan, Voice of Tajik	7245va
1300	1400	UK, BBC World Service	5875as 6190af
		6195as 9410as 9740as 11760me	
		11890as 12095af 15310as 15420af	
		15575me 17640af 17830as 21470af	
1300	1400	USA, American Forces Network/AFRTS	4319usb
		5446usb 5765usb 7812usb 12133usb	
		12759usb 13362usb	
1300	1400	Sat/Sun USA, BBG/Voice of America	7575as 9640as
		11700va 12150va	
1300	1400	USA, EWTVN/WEWN Irondale, AL	15610eu
1300	1400	USA, FBN/WTJC Newport NC	9370na
1300	1400	USA, KJES Vado NM	7555na
1300	1400	USA, WBCQ Monticello ME	9330am
1300	1400	Sun USA, WHRI Cypress Creek SC	9840na
1300	1400	USA, WTWW Lebanon TN	9479va
1300	1400	USA, WWCR Nashville TN	7490af 9980af
		13845eu 15825eu	
1300	1400	USA, WWRB Manchester TN	9395na
1300	1400	USA, WYFR/Family Radio Worldwide	5835as
		9310as 9390as 11520as 11540as	
1300	1400	Zambia, CVC Radio Christian Voice	6065af
		17695af	
1300	1400	Zambia, ZNBC/Radio Two	6165do
1330	1345	India, All India Radio/Delhi	6085do
1330	1400	India, All India Radio/External Svc	9690as
		11620as 13710as	
1330	1400	Turkey, Voice of Turkey	12035va
1330	1400	Vietnam, Voice of Vietnam/Overseas Svc	9840as
		12020as	

1400 UTC - 9AM EST / 8AM CST / 6AM PST

1400 1415	Sun	Germany, Pan American Broadcasting	15205as
1400 1430		Japan, Radio Japan NHK World 11695as 21560af	5955as
1400 1430		Serbia, International Radio Serbia	9635eu
1400 1430		Thailand, Radio Thailand World Svc	9725va
1400 1430		Turkey, Voice of Turkey	12035va
1400 1457		China, China Radio International 7300as 9460as 9700eu 9870as 11665as 13675na 15230na 17630af	5955as 9765eu 13740na
1400 1457		Netherlands, R Netherlands Worldwide	12080as
1400 1500		Anguilla/Caribbean Beacon/Univ Network 11775na	
1400 1500		Australia, ABC NT Alice Springs	2310do
1400 1500		Australia, ABC NT Katherine	2485do
1400 1500		Australia, ABC NT Tennant Creek	2325do
1400 1500		Australia, Radio Australia 7240pa 9590pa 11660as	5995va 6080as
1400 1500		Bahrain, Radio Bahrain	6010me
1400 1500	Sun	Canada, Bible Voice Broadcasting	15470as
1400 1500	Sat/Sun	Canada, CBC Northern Quebec Svc	9625na
1400 1500		Canada, CFRX Toronto ON	6070na
1400 1500		Canada, CFVP Calgary AB	6030na
1400 1500		Canada, CKZN St Johns NF	6160na
1400 1500		Canada, CKZU Vancouver BC	6160na
1400 1500	Sat/Sun	Equatorial Guinea, Radio East Africa/Malabo 15190af	
1400 1500		India, All India Radio/External Svc 11620as 13710as	9690as
1400 1500		Italy, IRRS-Shortwave/Overcomer Ministry 15190va	
1400 1500		Malaysia, RTM Kajang/Traxx FM	7295do
1400 1500		New Zealand, Radio NZ International	5950pa
1400 1500		Nigeria, Voice of Nigeria	9690af
1400 1500		Oman, Radio Sultanate of Oman	15140va
1400 1500	Sat	Palau, T8WH/ WHRI	9930as
1400 1500	DRM	Russia, Voice of Russia	7340as
1400 1500		Russia, Voice of Russia 7310as 11660as	4975va 7260as
1400 1500		South Africa, CVC 1 Africa Radio	13590af
1400 1500		UK, BBC World Service 5975as 6190af 6195as 9740as 11760me 11890as 15420af 17640af 17830as	5875as 9410as 12095af
1400 1500		USA, American Forces Network/AFRTS 5446usb 5765usb 7812usb 12759usb 13362usb	4319usb 12133usb
1400 1500		USA, BBG/Voice of America	6080af
1400 1500	mtwhf	USA, BBG/Voice of America 17650af 17715af	15580af
1400 1500		USA, BBG/Voice of America	7575as
1400 1500		USA, EWTN/WEWN Irondale, AL	15610eu
1400 1500		USA, FBN/WTJC Newport NC	9370na
1400 1500		USA, WBCQ Monticello ME	9330am
1400 1500	Sun	USA, WHRI Cypress Creek SC	21600af
1400 1500	Sat	USA, WHRI Cypress Creek SC	9680na
1400 1500		USA, WJHR International Milton FL	15550na
1400 1500		USA, WTWW Lebanon TN	9479va
1400 1500		USA, WWCR Nashville TN	7490af
1400 1500		USA, WWRB Manchester TN	9395na
1400 1500		USA, WYFR/Family Radio Worldwide 9365as 11560as	5835as
1400 1500		Zambia, CVC Radio Christian Voice 17695af	6065af
1400 1500		Zambia, ZNBC/Radio Two	6165do
1405 1435	Sun	Canada, Bible Voice Broadcasting	9390as
1415 1430		Germany, Pan American Broadcasting	15205as
1415 1500		Nepal, Radio Nepal	5005as
1420 1440		India, All India Radio/Itanagar	4990do
1430 1445	Sun	Germany, Pan American Broadcasting	15205as
1430 1445		India, All India Radio/Aizawl	5050do
1430 1445		India, All India Radio/Delhi	6085do
1430 1445		India, All India Radio/Jeypore5040do	9835do
1430 1445		India, All India Radio/Mumbai	4840do
1430 1500		Australia, Radio Australia	9475as
1430 1500	Sat	Canada, Bible Voice Broadcasting	15470af
1430 1500	Sat	India, All India Radio/Gangtok	4835do
1445 1500		Australia, HCJB Global Australia	15340as
1450 1500		India, All India Radio/Itanagar	4990do
1450 1500		India, All India Radio/Kurseong	4895do

1500 UTC - 10AM EST / 9AM CST / 7AM PST

1500 1515	Sun	Canada, Bible Voice Broadcasting	13740as
1500 1525	Sun	China, Haixa zhi Sheng/VO Strait 9505do	4940do
1500 1525	mh	Guam, TWR Asia/KTWR	15200as
1500 1529		Canada, Radio Canada International 11975as	9635as
1500 1530		Australia, HCJB Global Australia	15340as
1500 1530		Clandestine, Sudan Radio Service/SRS	17745af
1500 1530		India, All India Radio/Jeypore5040do	
1500 1530		USA, WRMI/Radio Prague relay	9955am
1500 1530		Vietnam, Voice of Vietnam/Overseas Svc 9840as 12020as	7285as
1500 1535	twas	Guam, TWR Asia/KTWR	15200as
1500 1550		New Zealand, Radio NZ International	5950pa
1500 1557		China, China Radio International 6095va 7325as 7405as 9525eu 9720va 9785as	5955as 9435eu 9870as
1500 1557		North Korea, Voice of Korea 13760eu 15245eu	9335na 11710na
1500 1559		South Africa, Channel Africa	9625af
1500 1600		Anguilla/Caribbean Beacon/Univ Network 11775na	
1500 1600		Australia, ABC NT Alice Springs	2310do
1500 1600		Australia, ABC NT Katherine	2485do
1500 1600		Australia, Radio Australia 7240pa 9475as 9590pa	5995va 6080as 11660as
1500 1600		Bahrain, Radio Bahrain	6010me
1500 1600		Bhutan, Bhutan Broadcasting Svc	6035do
1500 1600	Sat/Sun	Canada, CBC Northern Quebec Svc	9625na
1500 1600		Canada, CFRX Toronto ON	6070na
1500 1600		Canada, CFVP Calgary AB	6030na
1500 1600		Canada, CKZN St Johns NF	6160na
1500 1600		Canada, CKZU Vancouver BC	6160na
1500 1600	Sat/Sun	Equatorial Guinea, Radio East Africa/Malabo 15190af	
1500 1600		Malaysia, RTM Kajang/Traxx FM	7295do
1500 1600		Nigeria, Voice of Nigeria	15120af
1500 1600	DRM	Russia, Voice of Russia	7340as
1500 1600		Russia, Voice of Russia 9660as 9880as	4975va 9470va
1500 1600		South Africa, CVC 1 Africa Radio	13590af
1500 1600		Uganda, Dunamis Shortwave	4750do
1500 1600		UK, BBC World Service 6195as 9410as 9490af 11830me 12095af 15400af	5875as 6190af 9505as 15420af
1500 1600		USA, American Forces Network/AFRTS 5446usb 5765usb 7812usb 12759usb 13362usb	4319usb 12133usb
1500 1600		USA, BBG/Voice of America	4930af
1500 1600		USA, BBG/Voice of America	6080af
1500 1600		USA, BBG/Voice of America	7575as
1500 1600		USA, WBCQ Monticello ME	9330am
1500 1600	Sat	USA, WBCQ Monticello ME	15420am
1500 1600	Sun	USA, WHRI Cypress Creek SC	21600af
1500 1600	Sat	USA, WHRI Cypress Creek SC	9680na
1500 1600		USA, WINB Red Lion PA	13570ca
1500 1600		USA, WJHR International Milton FL	15550na
1500 1600		USA, WTWW Lebanon TN	9479va
1500 1600		USA, WWCR Nashville TN	7490af
1500 1600		USA, WWRB Manchester TN	9395na
1500 1600		USA, WYFR/Family Radio Worldwide 11610as 11995as 21840af	6180as
1500 1600		Zambia, CVC Radio Christian Voice 17695af	6065af
1500 1600		Zambia, ZNBC/Radio Two	6165do
1515 1530	Sat	Canada, Bible Voice Broadcasting	13670as
1530 1545		India, All India Radio/Aizawl	5050do
1530 1545		India, All India Radio/Bengaluru	9425do
1530 1545		India, All India Radio/Bhopal	4810do
1530 1545		India, All India Radio/Chennai	4920do
1530 1545		India, All India Radio/Delhi	5015do

1530 1545	India, All India Radio/External Svc	9910as
1530 1545	India, All India Radio/Guwahati	4940do
1530 1545	India, All India Radio/Hyderabad	4800do
1530 1545	India, All India Radio/Itanagar	4990do
1530 1545	India, All India Radio/Jaipur	4910do
1530 1545	India, All India Radio/Kolkata	4820do
1530 1545	India, All India Radio/Kurseong	4895do
1530 1545	India, All India Radio/Lucknow	4880do
1530 1545	India, All India Radio/Panaji, Goa	9820do
1530 1545	India, All India Radio/Port Blair	4760do
1530 1545	India, All India Radio/Radio Kashmir	4950do
1530 1545	India, All India Radio/Shillong	4970do
1530 1545	India, All India Radio/Shimla	4965do
1530 1545	India, All India Radio/Thiruvananthapuram	5010do
1530 1550 DRM	Vatican City State, Vatican Radio	15180as
1530 1550 Sat/DRM	Vatican City State, Vatican Radio	15190as
1530 1600	Afghanistan, Radio Afghanistan	7200as
1530 1600 DRM	Belgium, TDP Radio/Disco Palace	12115as
1530 1600 h	Canada, Bible Voice Broadcasting	13670as
1530 1600 smtwa	Germany, AWR Europe	15255as
1530 1600	Iran, IRIB/ VOIRI 13785as	15525as
1530 1600	Mongolia, Voice of Mongolia	12085as
1530 1600	Myanmar, Myanma Radio/National Svc	5985do
1530 1600 Sat	Vatican City State, Vatican Radio	7585as
	11850as	13765as
1551 1600	New Zealand, Radio NZ International	7440pa
1551 1600 DRM	New Zealand, Radio NZ International	5950pa

1600 UTC - 11AM EST / 10AM CST / 8AM PST

1600 1627	Iran, IRIB/ VOIRI 13785as	15525as
1600 1630	Australia, Radio Australia	9580as
1600 1630 DRM	Belgium, TDP Radio/Disco Palace	12115as
1600 1630	Guam, AWR/KSDA	11690as 11935as
	15215as	
1600 1630	Myanmar, Myanma Radio/National Svc	5985do
1600 1630	Vietnam, Voice of Vietnam/Overseas Svc	7220va
	7280va	9550va 9730va
1600 1650 DRM	New Zealand, Radio NZ International	5950pa
1600 1650	New Zealand, Radio NZ International	7440pa
1600 1657	China, China Radio International	6060as
	7235as	7255eu 7420af 7435af
	9435eu	9570af 9875eu
1600 1657	North Korea, Voice of Korea	9990va
1600 1700	Anguilla/Caribbean Beacon/Univ Network	11775na
1600 1700	Australia, ABC NT Alice Springs	2310do
1600 1700	Australia, ABC NT Katherine	2485do
1600 1700	Australia, Radio Australia	5995va 6080as
	7240pa	9475as 9710as 11660as
1600 1700	Bahrain, Radio Bahrain	6010me
1600 1700 Sat	Canada, CBC Northern Quebec Svc	9625na
1600 1700	Canada, CFRX Toronto ON	6070na
1600 1700	Canada, CFVP Calgary AB	6030na
1600 1700	Canada, CKZN St Johns NF	6160na
1600 1700	Canada, CKZU Vancouver BC	6160na
1600 1700	Egypt, Radio Cairo	15345af
1600 1700 Sat/Sun	Equatorial Guinea, Radio East Africa/Malabo	15190af
1600 1700	Ethiopia, Radio Ethiopia	7235va 9560va
1600 1700	Malaysia, RTM Kajang/Traxx FM	7295do
1600 1700 DRM	Russia, Voice of Russia	6180as
1600 1700	Russia, Voice of Russia	4975va 9470me
1600 1700	South Africa, CVC 1 Africa Radio	13590af
1600 1700	South Korea, KBS World Radio	9515eu
	9640as	
1600 1700	Taiwan, Radio Taiwan International	9440as
	12055as	
1600 1700	Uganda, Dunamis Shortwave	4750do
1600 1700	UK, BBC World Service	3255af 5875as
	5975as	6190af 9410as 9505as
	11830me	12095af 13790af 15400af
	15420af	17640af 17830as
1600 1700	USA, American Forces Network/AFRTS	4319usb
	5446usb	5765usb 7812usb 12133usb
	12759usb	13362usb
1600 1700	USA, BBG/Voice of America	4930af 6080af
	15580af	17895af
1600 1700	USA, BBG/Voice of America/Special English	
	13600va	15470va
1600 1700	USA, EWTN/WEWN Irondale, AL	15610eu

1600 1700	USA, FBN/WTJC Newport NC	9370na
1600 1700	USA, WBCQ Monticello ME	9330am
1600 1700 Sat	USA, WBCQ Monticello ME	15420am
1600 1700 Sun	USA, WHRI Cypress Creek SC	9840na
1600 1700	USA, WHRI Cypress Creek SC	11630af
1600 1700	USA, WINB Red Lion PA	13570ca
1600 1700	USA, WJHR International Milton FL	15550na
1600 1700	USA, WTWW Lebanon TN	9479va
1600 1700	USA, WWCR Nashville TN	9980af 12160af
	13845eu	15825eu
1600 1700	USA, WWRB Manchester TN	9395na
1600 1700	USA, WYFR/Family Radio Worldwide	17545af 11740as
1600 1700	Zambia, CVC Radio Christian Voice	6065af
	17695af	
1600 1700	Zambia, ZNBC/Radio Two	6165do
1630 1700 Sun	Canada, Bible Voice Broadcasting	9460me
1630 1700 m	South Africa, South African Radio League	4895af
1630 1700 mtwhf	USA, BBG/Voice of America	9790af 13635af
1645 1700 mtwhfa	Canada, Bible Voice Broadcasting	9460me
1651 1700 DRM	New Zealand, Radio NZ International	9890pa
1651 1700 smtwhf	New Zealand, Radio NZ International	9765pa
1658 1700 Sat	New Zealand, Radio NZ International	9765pa

1700 UTC - 12PM EST / 11AM CST / 9AM PST

1700 1710	Pakistan, PBC/Radio Pakistan	7530eu 9470eu
1700 1715 f	Canada, Bible Voice Broadcasting	9460me
1700 1720 th	Canada, Bible Voice Broadcasting	9460me
1700 1730 m	South Africa, South African Radio League	3230af
1700 1750 DRM	New Zealand, Radio NZ International	9890pa
1700 1750 smtwhf	New Zealand, Radio NZ International	9765pa
1700 1755	South Africa, Channel Africa	15235af
1700 1757	China, China Radio International	6090as
	6100eu	6140as 7205eu 7255eu
	7410as	7420as 7425as 9570af
	9600as	13685af
1700 1800	Anguilla/Caribbean Beacon/Univ Network	11775na
1700 1800	Australia, ABC NT Alice Springs	2310do
1700 1800	Australia, ABC NT Katherine	2485do
1700 1800	Australia, Radio Australia	5995va 6080as
	9475as	9580pa 9710as 11880pa
1700 1800	Bahrain, Radio Bahrain	6010me
1700 1800 Sat/Sun	Canada, Bible Voice Broadcasting	9460me
1700 1800 Sat	Canada, CBC Northern Quebec Svc	9625na
1700 1800	Canada, CFRX Toronto ON	6070na
1700 1800	Canada, CFVP Calgary AB	6030na
1700 1800	Canada, CKZN St Johns NF	6160na
1700 1800	Canada, CKZU Vancouver BC	6160na
1700 1800	Egypt, Radio Cairo	15345af
1700 1800 Sat/Sun	Equatorial Guinea, Radio Africa	7190af
1700 1800	Malaysia, RTM Kajang/Traxx FM	7295do
1700 1800 DRM	Russia, Voice of Russia	7300eu
1700 1800	Russia, Voice of Russia	4975va 7240as
	7270va	7330eu 9880as
1700 1800	South Africa, CVC 1 Africa Radio	4965af
	13590af	
1700 1800	Swaziland, TWR Africa	3200af
1700 1800	Taiwan, Radio Taiwan International	15690af
1700 1800	UK, BBC World Service	5875as 5975as
	6190af	7600as 9505as 12095af
	13790af	15400af 15420af 17640af
	17830af	
1700 1800	USA, American Forces Network/AFRTS	4319usb
	5446usb	5765usb 7812usb 12133usb
	12759usb	13362usb
1700 1800	USA, BBG/Voice of America	15580af 17895af
1700 1800	USA, EWTN/WEWN Irondale, AL	15610eu
1700 1800	USA, FBN/WTJC Newport NC	9370na
1700 1800	USA, WBCQ Monticello ME	9330am
1700 1800 Sat	USA, WBCQ Monticello ME	15420am
1700 1800	USA, WHRI Cypress Creek SC	21630af
1700 1800 Sun	USA, WHRI Cypress Creek SC	9840na
1700 1800	USA, WINB Red Lion PA	13570ca
1700 1800	USA, WJHR International Milton FL	15550na
1700 1800	USA, WTWW Lebanon TN	9479va
1700 1800	USA, WWCR Nashville TN	9980af 12160af
	13845eu	15825eu
1700 1800	USA, WWRB Manchester TN	9395na

1700	1800	USA, WYFR/Family Radio Worldwide	7395af	
		17545af		
1700	1800	Zambia, CVC Radio Christian Voice	4965af	
1700	1800	Zambia, ZNBC/Radio Two	6165do	
1730	1745	Canada, Bible Voice Broadcasting	9460me	
1730	1745	India, All India Radio/Bhopal	4810do	
1730	1745	India, All India Radio/Delhi	5015do	
		9575do	9835do	
1730	1745	India, All India Radio/Guwahati	4940do	
1730	1745	India, All India Radio/Hyderabad	4800do	
1730	1745	India, All India Radio/Jaipur	4910do	
1730	1745	India, All India Radio/Kolkata	4820do	
1730	1745	India, All India Radio/Kurseong	4895do	
1730	1745	India, All India Radio/Lucknow	4880do	
1730	1745	India, All India Radio/Radio Kashmir	4950do	
1730	1745	India, All India Radio/Shimla	4965do	
1730	1745	India, All India Radio/Thiruvananthapuram	5010do	
1730	1800	mtwhf	Clandestine, Sudan Radio Service/SRS	9590af
1730	1800		Turkey, Voice of Turkey	11735as
1730	1800		Vatican City State, Vatican Radio	9755af
			11625af	13765af
1740	1745		India, All India Radio/Chennai	4920do
1745	1800	Sat	Canada, Bible Voice Broadcasting	13810af
1745	1800	DRM	India, All India Radio/External Svc	9950eu
			11580af	
1745	1800		India, All India Radio/External Svc	7400af
			7410af	7550eu
			9415af	9445af
			11670eu	11935af
1751	1800	DRM	New Zealand, Radio NZ International	11675pa
1751	1800		New Zealand, Radio NZ International	11725pa
1758	1800	DRM	New Zealand, Radio NZ International	11675pa
1758	1800	Sat	New Zealand, Radio NZ International	11725pa

1800 UTC - 1PM EST / 12PM CST / 10AM PST

1800	1815	Sat	Canada, Bible Voice Broadcasting	7365as
1800	1830	w	Austria, AWR Europe	11690af
1800	1830	t	Canada, Bible Voice Broadcasting	9460me
1800	1830	DRM	Romania, Radio Romania International	5875eu
1800	1830		South Africa, AWR Africa	3215af
1800	1830		Turkey, Voice of Turkey	11735as
1800	1830		UK, BBC World Service	5975as
			9505as	7600as
1800	1830		USA, BBG/Voice of America	4930af
			13635af	15580af
1800	1830		Vietnam, Voice of Vietnam/Overseas Svc	5955va
1800	1850	DRM	New Zealand, Radio NZ International	11675pa
1800	1856	DRM	Romania, Radio Romania International	9745eu
1800	1856		Romania, Radio Romania International	11955eu
1800	1857		China, China Radio International	6100eu
			6165as	7405eu
			13685af	15425eu
1800	1857		North Korea, Voice of Korea	13760eu
1800	1859		Canada, Radio Canada International	9740va
			9770af	11845af
			15365af	17790af
1800	1900		Anguilla/Caribbean Beacon/Univ Network	11775na
1800	1900	mtwhf	Argentina, RAE	15345eu
1800	1900		Australia, ABC NT Alice Springs	2310do
1800	1900		Australia, ABC NT Katherine	2485do
1800	1900		Australia, Radio Australia	6080as
			9475as	9580pa
			9710as	11880pa
1800	1900		Bahrain, Radio Bahrain	6010me
1800	1900	Sun	Canada, Bible Voice Broadcasting	6110me
			9460me	
1800	1900	Sat	Canada, Bible Voice Broadcasting	6110me
1800	1900		Canada, CFRX Toronto ON	6070na
1800	1900		Canada, CFVP Calgary AB	6030na
1800	1900		Canada, CKZN St Johns NF	6160na
1800	1900		Canada, CKZU Vancouver BC	6160na
1800	1900	Sat/Sun	Equatorial Guinea, Radio Africa	7190af
1800	1900	DRM	India, All India Radio/External Svc	9950eu
			11580af	
1800	1900		India, All India Radio/External Svc	7400af
			7410af	7550eu
			9415af	9445af
			11670eu	11935af
1800	1900		Kuwait, Radio Kuwait	15540eu
1800	1900		Malaysia, RTM Kajang/Traxx FM	7295do
1800	1900		Netherlands, R Netherlands Worldwide	11655af
1800	1900		New Zealand, Radio NZ International	11725pa
1800	1900		Nigeria, Voice of Nigeria	15120af
1800	1900		Poland, Polskie Radio Warsaw	3955eu
1800	1900	DRM	Russia, Voice of Russia	6145eu
			7300eu	

1800	1900		Russia, Voice of Russia	7270va	7330eu
			11985va	12060eu	
1800	1900		South Africa, CVC 1 Africa Radio	4965af	
			13590af		
1800	1900		South Korea, KBS World Radio	7275eu	
1800	1900		Taiwan, Radio Taiwan International	3965eu	
1800	1900		UK, BBC World Service	3255af	5945as
			6190af	9430af	11810af
			15400af		
1800	1900		USA, American Forces Network/AFRTS	4319usb	
			5446usb	5765usb	7812usb
			12759usb	13362usb	
1800	1900		USA, EWTN/WEWN Irondale, AL	15610af	
1800	1900		USA, FBN/WTJC Newport NC	9370na	
1800	1900		USA, KJES Vado NM	15385na	
1800	1900		USA, WBCQ Monticello ME	9330am	
1800	1900	fas	USA, WHRI Cypress Creek SC	21630af	
1800	1900	Sat/Sun	USA, WHRI Cypress Creek SC	9840na	
1800	1900		USA, WINB Red Lion PA	13570ca	
1800	1900		USA, WJHR International Milton FL	15550na	
1800	1900		USA, WTWW Lebanon TN	9479va	
1800	1900		USA, WWCR Nashville TN	9980af	12160af
			13845eu	15825eu	
1800	1900		USA, WWRB Manchester TN	9395na	
1800	1900		USA, WYFR/Family Radio Worldwide	5890af	
			7385af	11665af	12140af
			13750af		
1800	1900		Zambia, CVC Radio Christian Voice	4965af	
			17695af		
1800	1900		Zambia, ZNBC/Radio Two	6165do	
1830	1845		India, All India Radio/Delhi	5015do	
1830	1900		Bulgaria, Radio Bulgaria	7400eu	9700eu
1830	1900	Sun	Italy, IRRS-Shortwave/Euro Gospel Radio	7290eu	
1830	1900		South Africa, AWR Africa	11830af	
1830	1900		UK, BBC World Service	9410af	
1830	1900		USA, BBG/Voice of America	4930af	6080af
			13635af	15580af	
1851	1900	DRM	New Zealand, Radio NZ International	15720pa	
1858	1900	Sat/DRM	New Zealand, Radio NZ International	15720pa	

1900 UTC - 2PM EST / 1PM CST / 11AM PST

1900	1915	Sun	Canada, Bible Voice Broadcasting	9460me	
1900	1928		Germany, Deutsche Welle	12045af	
1900	1930		Germany, Deutsche Welle	9735af	12070af
1900	1930		Vietnam, Voice of Vietnam/Overseas Svc	7280va	
			9730va		
1900	1945	DRM	India, All India Radio/External Svc	9950eu	
			11580af		
1900	1945		India, All India Radio/External Svc	7400af	
			7410af	7550eu	9415af
			9445af		
			11670eu	11935af	
1900	1950	DRM	New Zealand, Radio NZ International	15720pa	
1900	1957		China, China Radio International	7295as	
			7435`af	9440as	
1900	1957		Netherlands, R Netherlands Worldwide	11655af	
1900	1957		North Korea, Voice of Korea	7210af	9975va
			11535va	11910af	
1900	1959		Netherlands, R Netherlands Worldwide	11615af	
1900	2000		Anguilla/Caribbean Beacon/Univ Network	11775na	
1900	2000		Australia, ABC NT Alice Springs	2310do	
1900	2000		Australia, ABC NT Katherine	2485do	
1900	2000		Australia, Radio Australia	6080as	7240pa
			9500as	9580pa	9710as
			11880pa		
1900	2000		Bahrain, Radio Bahrain	6010me	
1900	2000	Sat	Canada, Bible Voice Broadcasting	9470me	
1900	2000	Sun	Canada, Bible Voice Broadcasting	6030eu	
1900	2000		Canada, CFRX Toronto ON	6070na	
1900	2000		Canada, CFVP Calgary AB	6030na	
1900	2000		Canada, CKZN St Johns NF	6160na	
1900	2000		Canada, CKZU Vancouver BC	6160na	
1900	2000		Egypt, Radio Cairo	11510af	
1900	2000	Sat/Sun	Equatorial Guinea, Radio Africa	7190af	
1900	2000		Indonesia, Voice of Indonesia	9526eu	
1900	2000		Italy, IRRS-Shortwave	7290va	
1900	2000	fas	Italy, IRRS-Shortwave/Overcomer Ministry	7290eu	
1900	2000		Kuwait, Radio Kuwait	15540eu	
1900	2000		Malaysia, RTM Kajang/Traxx FM	7295do	
1900	2000		Micronesia, The Cross Radio/Pohnpei	4755as	
1900	2000		Netherlands, R Netherlands Worldwide	7425af	
1900	2000		New Zealand, Radio NZ International	11725pa	
1900	2000	DRM	Russia, Voice of Russia	6040eu	
1900	2000		Russia, Voice of Russia	7330eu	

1900	2000		South Africa, CVC 1 Africa Radio	4965af
			13590af	
1900	2000	mtwhf	Spain, Radio Exterior de Espana	9605af
			9665eu	
1900	2000		Swaziland, TWR Africa	3200af
1900	2000		Thailand, Radio Thailand World Svc	9680eu
1900	2000		UK, BBC World Service	3255af 5945as
			6005af 9410af 9430af	11810af
			15400af	
1900	2000		USA, American Forces Network/AFRTS	4319usb
			5446usb 5765usb 7812usb	12133usb
			12759usb 13362usb	
1900	2000		USA, BBG/Voice of America	4930af 4940af
			6080af 7480va 9590va	15580af
1900	2000		USA, BBG/Voice of America/Special English	
			7480va 9590va	
1900	2000		USA, EWTN/WEWN Irondale, AL	15610af
1900	2000		USA, FBN/WTJC Newport NC	9370na
1900	2000		USA, WBCQ Monticello ME	9330am
1900	2000		USA, WHRI Cypress Creek SC	9840na
1900	2000		USA, WINB Red Lion PA	13570ca
1900	2000		USA, WJHR International Milton FL	15550na
1900	2000		USA, WTWW Lebanon TN	9479va
1900	2000		USA, WWCR Nashville TN	9980af
			13845eu 15825eu	12160af
1900	2000		USA, WWRB Manchester TN	9395na
1900	2000		USA, WYFR/Family Radio Worldwide	3230af
			6020af 9610af 9705af	9885af
			9925af 18980eu	
1900	2000		Zambia, CVC Radio Christian Voice	4965af
			13590af	
1900	2000		Zambia, ZNBC/Radio Two	6165do
1905	1920	Sat	Mali, ORTM/Radio Mali	9635do
1915	1945	Sat	Canada, Bible Voice Broadcasting	6030eu
1915	1945	Sun	Canada, Bible Voice Broadcasting	9470me
1930	2000	Sat/Sun	Germany, Pan American Broadcasting	9515af
1930	2000		Iran, IRIB/ VOIRI	6010eu 6115eu
			13670af 15450af	7320eu
1930	2000		Serbia, International Radio Serbia	6100eu
1930	2000		South Africa, RTE Radio Worldwide	5840af
1930	2000		Turkey, Voice of Turkey	6050va
1951	2000	DRM	New Zealand, Radio NZ International	17675pa
1958	2000	Sat/DRM	New Zealand, Radio NZ International	17675pa

2000 UTC - 3PM EST / 2PM CST / 12PM PST

2000	2015	Sat	Germany, Pan American Broadcasting	9515af
2000	2027		Iran, IRIB/ VOIRI	6010eu 6115eu
			13670af 15450af	7320eu
2000	2030		Egypt, Radio Cairo	11510af
2000	2030		South Africa, RTE Radio Worldwide	5840af
2000	2030		Swaziland, TWR Africa	3200af
2000	2030		Turkey, Voice of Turkey	6050va
2000	2030		Vatican City State, Vatican Radio	7365af
			9755af 11625af	
2000	2050	DRM	New Zealand, Radio NZ International	17675pa
2000	2057		China, China Radio International	5960eu
			5985af 7285eu 7295as	7415eu
			9440as 9600eu 11640af	13630af
2000	2057		Netherlands, R Netherlands Worldwide	7425af
			11615af	
2000	2100		Anguilla/Caribbean Beacon/Univ Network	
			11775na	
2000	2100		Australia, ABC NT Alice Springs	2310do
2000	2100		Australia, ABC NT Katherine	2485do
2000	2100		Australia, ABC NT Tennant Creek	2325do
2000	2100		Australia, Radio Australia	9500as 11650as
			11660pa 11880pa	
2000	2100	mtwhf	Australia, Radio Australia	7240pa
2000	2100	Sat/Sun	Australia, Radio Australia	6080as 7240pa
			12080va	
2000	2100		Bahrain, Radio Bahrain	6010me
2000	2100		Belarus, Radio Station Belarus	6155eu
			7360eu 7390eu	
2000	2100	DRM	Belgium, TDP Radio/Disco Palace	17755na
2000	2100		Canada, CFRX Toronto ON	6070na
2000	2100		Canada, CFPV Calgary AB	6030na
2000	2100		Canada, CKZN St Johns NF	6160na
2000	2100		Canada, CKZU Vancouver BC	6160na
2000	2100		Cuba, Radio Havana Cuba	11760ca
2000	2100	Sat/Sun	Equatorial Guinea, Radio Africa	7190af
2000	2100		Germany, Deutsche Welle	9655af 9735af
			12070af	

2000	2100		Kuwait, Radio Kuwait	15540eu
2000	2100		Malaysia, RTM Kajang/Traxx FM	7295do
2000	2100		Micronesia, The Cross Radio/Pohnpei	4755as
2000	2100		New Zealand, Radio NZ International	11725pa
2000	2100	DRM	Russia, Voice of Russia	6040eu
2000	2100		Russia, Voice of Russia	7330eu
2000	2100		South Africa, CVC 1 Africa Radio	4965af
			9505af	
2000	2100		UK, BBC World Service	3255af 6005af
			6190af 9410af 9430af	11810af
			15400af	
2000	2100		USA, American Forces Network/AFRTS	4319usb
			5446usb 5765usb 7812usb	12133usb
			12759usb 13362usb	
2000	2100	mtwhf	USA, BBG/Voice of America	7470va 9480va
			9490va	
2000	2100		USA, EWTN/WEWN Irondale, AL	15610af
2000	2100		USA, FBN/WTJC Newport NC	9370na
2000	2100		USA, WBCQ Monticello ME	9330am
2000	2100	smtwhf	USA, WBCQ Monticello ME	7490am
2000	2100	Sun	USA, WHRI Cypress Creek SC	9895va
2000	2100	Sat	USA, WHRI Cypress Creek SC	17520af
2000	2100		USA, WINB Red Lion PA	13570ca
2000	2100		USA, WJHR International Milton FL	15550na
2000	2100		USA, WTWW Lebanon TN	9479va
2000	2100		USA, WWCR Nashville TN	9980af
			13845eu 15825eu	12160af
2000	2100		USA, WWRB Manchester TN	9395na
2000	2100		USA, WYFR/Family Radio Worldwide	6020af
			9925af 15195af 15520af	
2000	2100		Zambia, CVC Radio Christian Voice	4965af
			13590af	
2000	2100		Zambia, ZNBC/Radio Two	6165do
2030	2045		Thailand, Radio Thailand World Svc	9535eu
2030	2100		USA, BBG/Voice of America	4930af 6080af
			7560as 15580af	
2030	2100	Sat/Sun	USA, BBG/Voice of America	4940af
2030	2100		Vietnam, Voice of Vietnam/Overseas Svc	7220va
			7280va 9550va 9730va	
2045	2100		India, All India Radio/External Svc	7550eu
			9445eu 9910pa 11620pa	11670eu
			11715pa	
2045	2100	DRM	India, All India Radio/External Svc	9950eu
2045	2100	DRM	Vatican City State, Vatican Radio	9800am
2050	2100		Vatican City State, Vatican Radio	3975eu
			6075eu 7250eu	
2051	2100	DRM	New Zealand, Radio NZ International	15720pa

2100 UTC - 4PM EST / 3PM CST / 1PM PST

2100	2127		China, China Radio International	11640af
			13630af	
2100	2130	mtwhfa	Albania, Radio Tirana	7530na
2100	2130		Australia, ABC NT Alice Springs	2310do
2100	2130		Australia, ABC NT Katherine	2485do
2100	2130		Australia, ABC NT Tennant Creek	2325do
2100	2130		Austria, AWR Europe	9830af
2100	2130	Sat	Canada, CBC Northern Quebec Svc	9625na
2100	2150		New Zealand, Radio NZ International	11725pa
2100	2150	DRM	New Zealand, Radio NZ International	15720pa
2100	2157		China, China Radio International	5960eu
			5690eu 7205af 7285eu	7405af
			7415eu 9600eu	
2100	2157		North Korea, Voice of Korea	13760eu 15245eu
2100	2200		Angola, Angolan National Radio	7217af
2100	2200		Anguilla/Caribbean Beacon/Univ Network	
			11775na	
2100	2200		Australia, Radio Australia	9500as 9660pa
			11650as 11660pa 11695va	12080va
			13630va 15515va	
2100	2200		Bahrain, Radio Bahrain	6010me
2100	2200		Belarus, Radio Station Belarus	6155eu
			7360eu 7390eu	
2100	2200		Canada, CFRX Toronto ON	6070na
2100	2200		Canada, CFPV Calgary AB	6030na
2100	2200		Canada, CKZN St Johns NF	6160na
2100	2200		Canada, CKZU Vancouver BC	6160na
2100	2200	Sat/Sun	Equatorial Guinea, Radio Africa	7190af
2100	2200		Germany, Deutsche Welle	12070af
2100	2200		India, All India Radio/External Svc	7550eu
			9445eu 9910pa 11620pa	11715pa
2100	2200	DRM	India, All India Radio/External Svc	9950eu
2100	2200		Malaysia, RTM Kajang/Traxx FM	7295do

2100	2200	Micronesia, The Cross Radio/Pohnpei	4755	as
2100	2200	Russia, Voice of Russia	7300eu	
2100	2200	South Africa, CVC 1 Africa Radio	4965af	
2100	2200	Syria, Radio Damascus	9330va	
2100	2200	UK, BBC World Service	3255af	3915as
		5875as	5905af	5910af
		6190af	6195as	9410af
		12095af		9915af
2100	2200	USA, American Forces Network/AFRTS	4319usb	
		5446usb	5765usb	7812usb
		12759usb	13362usb	12133usb
2100	2200	USA, BBG/Voice of America	6080af	15580af
2100	2200	USA, EWTVN/WEWN Irondale, AL		15610af
2100	2200	USA, FBN/WTJC Newport NC		9370na
2100	2200	USA, WBCQ Monticello ME	9330am	15420am
2100	2200	USA, WBCQ Monticello ME	7490am	
2100	2200	USA, WHRI Cypress Creek SC		9490va
2100	2200	USA, WINB Red Lion PA	13570ca	
2100	2200	USA, WJHR International Milton FL		15550na
2100	2200	USA, WTWW Lebanon TN	9479va	
2100	2200	USA, WWCN Nashville TN	7465eu	9350af
		9980af	13845eu	
2100	2200	USA, WWRB Manchester TN	3215na	9395na
2100	2200	USA, WYFR/Family Radio Worldwide	7425af	
		9925af	15195af	
2100	2200	Zambia, CVC Radio Christian Voice	4965af	
		13590af		
2100	2200	Zambia, ZNBC/Radio Two	6165do	
2115	2200	Egypt, Radio Cairo	6270eu	
2130	2156	Romania, Radio Romania International	6030na	
		7310na	7380na	9435na
2130	2200	Australia, ABC NT Alice Springs		4835do
2130	2200	Australia, ABC NT Katherine	5025do	
2130	2200	Canada, CBC Northern Quebec Svc		9625na
2130	2200	Turkey, Voice of Turkey	9610va	
2151	2200	New Zealand, Radio NZ International		15720pa
2151	2200	DRM New Zealand, Radio NZ International		17675pa
2158	2200	Sat New Zealand, Radio NZ International		15720pa
2158	2200	Sat/DRM New Zealand, Radio NZ International		17675pa

2200 UTC - 5PM EST / 4PM CST / 2PM PST

2200	2205	Zambia, ZNBC/Radio Two	6165do	
2200	2215	USA, WBCQ Monticello ME	7490am	
2200	2230	India, All India Radio/External Svc	7550eu	
		9445eu	9445eu	9910pa
		11670eu	11715pa	11620pa
2200	2230	DRM India, All India Radio/External Svc	9950eu	
2200	2230	Serbia, International Radio Serbia	6100eu	
2200	2230	South Korea, KBS World Radio	3955eu	
2200	2230	Turkey, Voice of Turkey	9610va	
2200	2245	Egypt, Radio Cairo	6270eu	
2200	2257	China, China Radio International	5915as	
2200	2300	Anguilla/Caribbean Beacon/Univ Network	6090na	
2200	2300	Australia, ABC NT Alice Springs	4835do	
2200	2300	Australia, ABC NT Katherine	5025do	
2200	2300	Australia, Radio Australia	9855as	11550as
		12080va	13630va	15230va
		15515va		15240va
2200	2300	fa Australia, Radio Australia	9660pa	
2200	2300	Bahrain, Radio Bahrain	6010me	
2200	2300	Bulgaria, Radio Bulgaria	5900eu	7400eu
2200	2300	smtwhf Canada, CBC Northern Quebec Svc		9625na
2200	2300	Canada, CFRX Toronto ON	6070na	
2200	2300	Canada, CFVP Calgary AB	6030na	
2200	2300	Canada, CKZN St Johns NF	6160na	
2200	2300	Canada, CKZU Vancouver BC	6160na	
2200	2300	Sat/Sun Equatorial Guinea, Radio Africa	7190af	
2200	2300	Malaysia, RTM Kajang/Traxx FM	7295do	
2200	2300	Micronesia, The Cross Radio/Pohnpei	4755	as
2200	2300	New Zealand, Radio NZ International	15720pa	
2200	2300	DRM New Zealand, Radio NZ International	17675pa	
2200	2300	Russia, Voice of Russia	7250va	11830na
2200	2300	Sat/Sun Spain, Radio Exterior de Espana	6125eu	
2200	2300	UK, BBC World Service	3915as	5875as
		5890as	5965as	6190af
		7490as	9915af	12095af
2200	2300	USA, American Forces Network/AFRTS	4319usb	
		5446usb	5765usb	7812usb
		12759usb	13362usb	12133usb

2200	2300	smtwh	USA, BBG/Voice of America	5840as	7365as
			7425pa	7570va	11860va
2200	2300		USA, EWTVN/WEWN Irondale, AL		15610af
2200	2300		USA, FBN/WTJC Newport NC		9370na
2200	2300	smwhf	USA, WBCQ Monticello ME	7490am	
2200	2300		USA, WBCQ Monticello ME	9330am	
2200	2300	Sat	USA, WHRI Cypress Creek SC		9490va
2200	2300	f	USA, WHRI Cypress Creek SC		15180na
2200	2300	Sat	USA, WHRI Cypress Creek SC		9505va
2200	2300		USA, WINB Red Lion PA	9265ca	
2200	2300		USA, WTWW Lebanon TN	9479va	
2200	2300		USA, WWCN Nashville TN	7465eu	9350af
			9980af	13845eu	
2200	2300		USA, WWRB Manchester TN	3215na	5050va
			5745va	9395na	
2230	2300		Guam, AWR/KSDA	15320as	
2230	2300	fa	Palau, T8WH/ WHRI	9930as	
2230	2300		USA, BBG/Voice of America	7545as	9570pa
2230	2300		USA, BBG/Voice of America/Special English		
			5810va	7545va	9570va
2245	2300		India, All India Radio/External Svc	6055as	
			7305as	11645as	13605as

2300 UTC - 6PM EST / 5PM CST / 3PM PST

2300	0000		Anguilla/Caribbean Beacon/Univ Network	6090na	
2300	0000		Australia, ABC NT Alice Springs		4835do
2300	0000		Australia, ABC NT Katherine	5025do	
2300	0000		Australia, Radio Australia	9855as	9660pa
			12080va	13690va	15230va
			17795pa		15515pa
2300	0000		Bahrain, Radio Bahrain	6010me	
2300	0000	smtwhf	Canada, CBC Northern Quebec Svc		9625na
2300	0000		Canada, CFRX Toronto ON	6070na	
2300	0000		Canada, CFVP Calgary AB	6030na	
2300	0000		Canada, CKZN St Johns NF	6160na	
2300	0000		Canada, CKZU Vancouver BC		6160na
2300	0000		Egypt, Radio Cairo	6270na	
2300	0000		India, All India Radio/External Svc	6055as	
			7305as	11645as	13605as
2300	0000		Malaysia, RTM Kajang/Traxx FM	7295do	
2300	0000		Micronesia, The Cross Radio/Pohnpei	4755	as
2300	0000		New Zealand, Radio NZ International	15720pa	
2300	0000	DRM	New Zealand, Radio NZ International	17675pa	
2300	0000		Russia, Voice of Russia	7250va	7290va
2300	0000		Turkey, Voice of Turkey	5960va	
2300	0000		UK, BBC World Service	3915as	5875as
			5980as	6195as	7490as
			11955as		9740as
2300	0000		USA, American Forces Network/AFRTS	4319usb	
			5446usb	5765usb	7812usb
			12759usb	13362usb	12133usb
2300	0000		USA, BBG/Voice of America	5840as	5895as
			7365as	7460as	7480pa
			9490va	11840va	11860va
2300	0000		USA, EWTVN/WEWN Irondale, AL		15610af
2300	0000		USA, FBN/WTJC Newport NC		9370na
2300	0000	smtwhf	USA, WBCQ Monticello ME	7490am	
2300	0000		USA, WBCQ Monticello ME	9330am	
2300	0000	Sat	USA, WHRI Cypress Creek SC		9505va
2300	0000	smtwhf	USA, WHRI Cypress Creek SC		7385ca
2300	0000		USA, WINB Red Lion PA	9265ca	
2300	0000		USA, WTWW Lebanon TN	9479va	
2300	0000		USA, WWCN Nashville TN	3195eu	5070af
			9980af	13845eu	
2300	0000		USA, WWRB Manchester TN	3215na	5050va
			5745va	9395na	
2300	0000		USA, WYFR/Family Radio Worldwide	9430ca	
			15400ca		
2300	2330		Australia, Radio Australia	15240as	
2300	2330	DRM	Vatican City State, Vatican Radio	7370am	
2300	2356		Romania, Radio Romania International	6015eu	
			7220eu	7300eu	9530eu
2300	2357		China, China Radio International	5915as	
			5990me	6040na	6145as
			7415as	9535as	11790as
					11970va
2315	2330		Croatia, Voice of Croatia	3985ca	7375eu
2330	0000		Australia, Radio Australia	15415va	17750va
2330	0000		Vietnam, Voice of Vietnam/Overseas Svc	9840as	
			12020as		
2330	2345		India, All India Radio/Aligarh	9470do	



MTXTRA

Shortwave Broadcast Guide

CHINESE / SPANISH

The following language schedule is extracted from our new MTXtra Shortwave Broadcast Guide pdf which is a free download to all MTXpress subscribers. This new online Shortwave Broadcast Guide has more than 9,100 station entries that include all languages being broadcasts via shortwave radio worldwide, sorted by time and updated monthly.

1400 UTC - 9AM EST / 8AM CST / 6AM PST

1400 1415	China, YunNan PBS	6035do	
1400 1426	Romania, Radio Romania International	9660as	
	11825as		
1400 1440	China, Hulun Buir PBS	3900do	
1400 1457	China, China Radio International	6040as	
	7400as	7410as	7445as
	9730as	11610as	11785me
1400 1500	China, China Business Radio/Beijing	3985do	
	6155do	7245do	7370do
	9515do	9775do	9820do
	15500do		15270do
1400 1500	China, China Business Radio/Xianyang	3985do	
	6065do	6155do	7265do
	9810do	11740do	11915do
1400 1500	China, China Business Radio/Xinjie	3985do	
	6000do	6065do	7315do
	9620do	11660do	11835do
1400 1500	China, Hunan PBS	4990do	
1400 1500	China, Nei Menggu PBS	7420do	9520do
1400 1500	China, Sichuan PBS2	6060do	7225do
1400 1500	China, Tibet PBS	4820do	5935do
	7240do	7450do	6050do
1400 1500	China, Voice of China	4460do	4750do
	4800do	5945do	6000do
	6080do	6125do	6175do
	7230do	7275do	7290do
	7345do	7365do	9500do
	9845do	9810do	11960do
1400 1500	China, Xinjiang PBS	3950do	5060do
	5960do	7310do	
1400 1500	China, YunNan PBS/Minority Svc	7210do	
1400 1500	Clandestine, Sound of Hope Radio Intl	9450as	
	15750as		
1400 1500	USA, BBG/Voice of America	6105as	7295as
	7525as	9390as	9785as
1400 1500	USA, KNLS Anchor Point AK	9615as	
1400 1500	USA, WYFR/Family Radio Worldwide	6240as	
	9280as	9865as	11725as
1430 1500	Japan, Radio Japan NHK World	6190as	
1430 1500	Mongolia, Voice of Mongolia	12085as	

1500 UTC - 10AM EST / 9AM CST / 7AM PST

1500 1515	China, Sichuan PBS2	6060do	7225do
1500 1557	China, China Radio International	5910as	
	7255as	7265as	9455as
	9705eu	9740na	13675na
1500 1600	China, China Business Radio/Beijing	3985do	
	6155do	7245do	7370do
	9515do	9775do	9820do
	15500do		15270do
1500 1600	China, China Business Radio/Xianyang	3985do	
	6065do	6155do	7265do
	9810do	11740do	11915do
1500 1600	China, China Business Radio/Xinjie	3985do	
	6000do	6065do	7315do
	9620do	11660do	11835do
1500 1600	China, Hunan PBS	4990do	
1500 1600	China, Nei Menggu PBS	7420do	9520do
1500 1600	China, Tibet PBS	4820do	5935do
	7240do	7450do	6050do
1500 1600	China, Voice of China	4460do	4750do
	4800do	5945do	6000do
	6080do	6125do	6175do
	7230do	7275do	7290do
	7345do	7365do	9500do
	9845do	9810do	11960do
1500 1600	China, Xinjiang PBS	3950do	5060do
	5960do	7310do	

1500 1600	Clandestine, Sound of Hope Radio Intl	9450as
	12130as	
1500 1600	USA, WYFR/Family Radio Worldwide	6240as
1530 1600	Japan, Radio Japan NHK World	6190as

1600 UTC - 11AM EST / 10AM CST / 8AM PST

1600 1605	China, China Business Radio/Beijing	3985do	
	6155do	7370do	9515do
	15270do	15500do	
1600 1605	China, China Business Radio/Xianyang	3985do	
	6065do	6155do	7265do
	9810do	11740do	11915do
1600 1605	China, China Business Radio/Xinjie	3985do	
	6000do	6065do	7315do
	9620do	11660do	11835do
1600 1630	Clandestine, Sound of Hope Radio Intl	11765as	
	12130as		
1600 1630	Clandestine, Sound of Hope Radio Intl	12130as	
1600 1630	Japan, Radio Japan NHK World	9540as	
1600 1657	China, China Radio International	7220as	
	7335as	17735as	
1600 1700	China, Hunan PBS	4990do	
1600 1700	China, Tibet PBS	4820do	5935do
	7240do	7450do	6050do
1600 1700	China, Voice of China	4460do	4750do
	4800do	5945do	6000do
	6080do	6125do	6175do
	7230do	7275do	7290do
	7345do	7365do	9500do
	9845do	9810do	11960do
1600 1700	China, Xinjiang PBS	3950do	5060do
	5960do	7310do	
1600 1700	Clandestine, Sound of Hope Radio Intl	11765as	
1605 1700	China, Nei Menggu PBS	7420do	9520do

1700 UTC - 12PM EST / 11AM CST / 9AM PST

1700 1735	China, Voice of China	4460do	4750do
	4800do	5945do	6000do
	6125do	6175do	7215do
	7275do	7290do	7305do
	7365do	9500do	9675do
	9845do	11960do	9810do
1700 1800	China, Nei Menggu PBS	7420do	9520do
1700 1800	China, Tibet PBS	4820do	5935do
	7240do	7450do	6050do
1700 1800	China, Xinjiang PBS	3950do	5060do
	5960do	7310do	
1730 1745	Serbia, International Radio Serbia	9635eu	
1730 1800	China, China Radio International	6150me	
	7275me	7315eu	7445va
			9695eu

1800 UTC - 1PM EST / 12PM CST / 10AM PST

1800 1805	China, Tibet PBS	4820do	5935do
	7240do	7450do	6050do
1800 1827	China, China Radio International	6150me	
	7275me	7315eu	7445va
1800 1900	China, Nei Menggu PBS	7420do	9520do
1800 1900	China, Tibet PBS	4820do	5935do
	7240do	7450do	6050do

1900 UTC - 2PM EST / 1PM CST / 11AM PST

1900 2000	China, Nei Menggu PBS	7420do	9520do
1900 2000	China, Tibet PBS	4820do	5935do
	7240do	7450do	6050do

1955 2000	China, Voice of China	4460do	4750do
	4800do	5945do	6030do
	6125do	6175do	6180do
	7230do	7275do	7290do
	7345do	9455do	9500do
	9655do	9675do	9810do
	11710do	11925do	11960do
	15390do		12055do

2000 UTC - 3PM EST / 2PM CST / 12PM PST

2000 2057	China, China Radio International	7245eu	
	7305eu	7335af	7440eu
2000 2100	China, Nei Menggu PBS	7420do	9520do
2000 2100	China, Tibet PBS	4820do	5935do
	7240do	7450do	6050do
2000 2100	China, Voice of China	4460do	4750do
	4800do	5945do	6030do
	6125do	6175do	7215do
	7275do	7290do	7305do
	9455do	9500do	9630do
	9675do	9810do	9845do
	11925do	11960do	12055do
2055 2100	China, China Business Radio/Beijing	3985do	
	6040do	6155do	7245do
	7375do	9775do	11800do
2055 2100	China, China Business Radio/Xi'an	3985do	
	7255do	7315do	7335do
	11740do		9775do
2055 2100	China, China Business Radio/Xianyang	3985do	
	6065do	6155do	7265do
	9810do	11740do	11915do
2055 2100	China, China Business Radio/Xinjie	3985do	
	6000do	6065do	6155do
	7315do	7425do	9515do
	9775do	9820do	11835do

2100 UTC - 4PM EST / 3PM CST / 1PM PST

2100 2157	North Korea, Voice of Korea	7235as	9345as
	9975as	11535as	
2100 2200	China, China Business Radio/Beijing	3985do	
	7370do	7375do	9515do
	11610do	17625do	9775do
2100 2200	China, China Business Radio/Xi'an	3985do	
	7255do	7315do	7335do
	11740do		9775do
2100 2200	China, China Business Radio/Xianyang	3985do	
	6065do	6155do	7265do
	9810do	11740do	11915do
2100 2200	China, China Business Radio/Xinjie	3985do	
	6000do	6065do	7315do
	9515do	9775do	9820do
	11835do		11740do
2100 2200	China, Nei Menggu PBS	7420do	9520do
2100 2200	China, Tibet PBS	4820do	5935do
	7240do	7450do	6050do
2100 2200	China, Voice of China	4460do	4750do
	4800do	5945do	6030do
	6125do	6175do	6180do
	7230do	7290do	7305do
	9455do	9500do	9630do
	9675do	9810do	9845do
	11925do	11960do	12055do
2100 2200	USA, WYFR/Family Radio Worldwide	9280as	
2130 2200	China, Hunan PBS	4990do	
2130 2200	China, Hunan PBS	4990do	
2155 2200	China, Sichuan PBS2	6060do	7225do

2200 UTC - 5PM EST / 4PM CST / 2PM PST

2200 2230	Vietnam, Voice of Vietnam/Overseas Svc	7220as	
	12000as		
2200 2245	Vatican City State, Vatican Radio	5900as	
	7395as	9600as	
2200 2257	China, China Radio International	5975af	
	6100as	6140af	7220as
	7305af	7325af	7405pa
	7440as	15505as	7430as
2200 2257	North Korea, Voice of Korea	7235as	9345as
	9975as	11535as	
2200 2300	China, China Business Radio/Beijing	3985do	
	6040do	6155do	7245do
	7375do	9515do	9775do
	15500do	17625do	11800do

2200 2300	China, China Business Radio/Xi'an	3985do	
	7255do	7315do	7335do
	11740do		9775do
2200 2300	China, China Business Radio/Xianyang	3985do	
	6065do	6155do	7265do
	9810do	11740do	11915do
2200 2300	China, China Business Radio/Xinjie	3985do	
	6000do	6065do	7315do
	9515do	9820do	11740do
2200 2300	China, Hulun Buir PBS	3900do	
2200 2300	China, Hunan PBS	4990do	
2200 2300	China, Nei Menggu PBS	7420do	9520do
2200 2300	China, Sichuan PBS2	6060do	7225do
2200 2300	China, Tibet PBS	4820do	5935do
	7240do	7450do	6050do
2200 2300	China, Voice of China	4460do	6080do
	6175do	6180do	7215do
	7275do	7290do	7345do
	9500do	9655do	9845do
	11925do	11960do	12055do
2200 2300	Clandestine, Sound of Hope Radio Intl	7105as	
	9635as		
2200 2300	France, Radio France Internationale	11965as	
2200 2300	South Korea, KBS World Radio	7275as	
2200 2300	USA, BBG/Voice of America	6045as	7440as
	9545as	9755as	9875as
2200 2300	USA, WYFR/Family Radio Worldwide	6230as	
	9280as		
2220 2300	China, Gannan PBS	3990do	5970do
2230 2250	Japan, Radio Japan NHK World	9560as	
2230 2257	China, China Radio International	5975af	
	6100as	6140af	7220as
	7305af	7325af	7405pa
	7440as	11975as	15505as
2230 2300	China, YunNan PBS	6035do	
2230 2300	Vietnam, Voice of Vietnam/Overseas Svc	9840as	
	12020as		
2240 2300	Japan, Radio Japan NHK World	13650as	
2255 2300	China, YunNan PBS/Minority Svc	7210do	

2300 UTC - 6PM EST / 5PM CST / 3PM PST

2300 0000	China, China Business Radio/Beijing	3985do	
	6065do	9515do	9620do
	11610do	11670do	17625do
2300 0000	China, China Business Radio/Xi'an	3985do	
	7255do	7315do	7335do
	11740do		9775do
2300 0000	China, China Business Radio/Xianyang	3985do	
	6065do	6155do	7265do
	9810do	11740do	11915do
2300 0000	China, Gannan PBS	3990do	5970do
2300 0000	China, Hulun Buir PBS	3900do	
2300 0000	China, Hunan PBS	4990do	
2300 0000	China, Nei Menggu PBS	7420do	9520do
2300 0000	China, Sichuan PBS2	6060do	7225do
2300 0000	China, Tibet PBS	4820do	5935do
	7240do	7450do	6050do
2300 0000	China, Voice of China	4460do	4750do
	4800do	5945do	6030do
	6175do	6180do	7215do
	7290do	7345do	9455do
	9630do	9655do	9675do
	9810do	9845do	11710do
	12055do	13610do	13700do
2300 0000	China, YunNan PBS	6035do	
2300 0000	China, YunNan PBS/Minority Svc	7210do	
2300 0000	Clandestine, Sound of Hope Radio Intl	7310as	
	7550as		
2300 0000	France, Radio France Internationale	9955as	
	11665as		
2300 0000	South Korea, KBS World Radio	9805as	
2300 0000	Taiwan, Fu Hsing Brc. Corp/Network 3	9410do	
	9774do	15375do	
2300 0000	USA, WYFR/Family Radio Worldwide	6230as	
	9280as	9540as	
2300 2357	China, China Radio International	7295af	
	7300eu	7425as	9555as
2330 0000	China, Voice of China	4460do	9645do
	9675do	9710do	11720do
2330 0000	China, Xinjiang PBS	3950do	5060do
	5960do	7310do	
2330 0000	Iran, IRIB/ VOIRI	5955as	6110as
2340 0000	Japan, Radio Japan NHK World	15195as	
	17810as		

MT Spanish Language Shortwave Broadcast Guide

0000 UTC - 7PM EST / 6PM CST / 4PM PST

0000	0029	Canada, Radio Canada International	9785sa
		11990sa	
0000	0030	Peru, Radio San Antonio	4940do
0000	0045	USA, WYFR/Family Radio Worldwide	6915sa
0000	0056	Romania, Radio Romania International	7315ca
		9525ca	13590sa
0000	0057	China, China Radio International	5990ca
		9590eu	9800sa
		15120sa	
0000	0057	Netherlands, R Netherlands Worldwide	6165sa
0000	0057	North Korea, Voice of Korea	11735ca
		15180sa	13760ca
0000	0100	Sat/Sun Argentina, RAE	6060am
0000	0100	Bolivia, Radio Eco	4409do
0000	0100	twhfa Bolivia, Radio Fides	6155do
0000	0100	Bolivia, Radio Illimani/Radio Patria Nueva	6025do
0000	0100	Bolivia, Radio Logos	4865do
0000	0100	Bolivia, Radio Mosoj Chaski	3310do
0000	0100	Bolivia, Radio Nacional	5965do
0000	0100	Bolivia, Radio Pio XII	5952do
0000	0100	Bolivia, Radio San Gabriel	6080do
0000	0100	Bolivia, Radio San Jose	5580do
0000	0100	Bolivia, Radio San Miguel	4700do
0000	0100	Bolivia, Radio Santa Cruz	6135do
0000	0100	Bolivia, Radio Tacana	4782do
0000	0100	Bolivia, Radio Virgen de Remedios	4835do
0000	0100	Bolivia, Yatun Ayllu Yura/Radio Yura	4717do
0000	0100	Chile, CVC Voz Crista	9635sa
0000	0100	Clandestine, Radio Republica	9490ca
0000	0100	Colombia, La Voz de tu Conciencia	6010do
0000	0100	Colombia, La Voz del Guaviare	6035do
0000	0100	Colombia, Marfil Estereo	5910do
0000	0100	Cuba, Radio Havana Cuba	6000na
		9540na	9740sa
0000	0100	Cuba, Radio Rebelde	5025na
0000	0100	Dominican Republic, Radio Amanecer Intl	6025do
0000	0100	Ecuador, La Voz del Napo	3280do
0000	0100	Ecuador, Radio El Buen Pastor	4815do
0000	0100	Ecuador, Radio Quito	4919do
0000	0100	Honduras, HRMI/ Radio Misiones Intl	3340do
0000	0100	Mexico, Radio Educacion	6185do
0000	0100	Mexico, Radio Mil Onda Corta	6010do
0000	0100	Mexico, Radio Transcontinental de America	4800do
0000	0100	Mexico, Radio Universidad	6045do
0000	0100	Peru, La Voz de la Selva	4824do
0000	0100	Peru, La Voz de las Huarinjas	5059do
0000	0100	Peru, Ondas del Huallaga	3329do
0000	0100	Peru, Radio Altura 5014do	
0000	0100	Peru, Radio Bethel	5921do
0000	0100	Peru, Radio Bolivar	5460do
0000	0100	Peru, Radio Cusco	6195do
0000	0100	Peru, Radio Genesis	4850do
0000	0100	Peru, Radio Huanta 2000	4747do
0000	0100	Peru, Radio Madre de Dios	4950do
0000	0100	Peru, Radio Manantial	4986do
0000	0100	Peru, Radio Maranon	4835do
0000	0100	Peru, Radio Ondas del Suroiente	5120do
0000	0100	Peru, Radio Sicuani	4826do
0000	0100	Peru, Radio Tarma	4775do
0000	0100	Peru, Radio Tawantinsuyo	6174do
0000	0100	Peru, Radio Victoria	6019do
0000	0100	Peru, Radio Vision 4790do	9720do
0000	0100	Russia, Voice of Russia	9430sa
0000	0100	DRM Spain, Radio Exterior de Espana	9630na
		11815sa	
0000	0100	Spain, Radio Exterior de Espana	6125sa
		9535na	9620sa
		9765sa	
0000	0100	USA, BBG/Radio Marti	6030ca
		11775ca	7365ca
0000	0100	USA, EWTN/WEWN Irondale, AL	5810ca
		11870sa	
0000	0100	USA, WYFR/Family Radio Worldwide	5930sa
		5985ca	11530sa
		11835na	11855ca
0000	0100	Venezuela, Radio Amazonas	4940do
0030	0100	Iran, IRIB/ VOIRI	6010sa
		6110al	7345sa

0030	0100	twhfa USA, BBG/Voice of America	5890ca	9885ca
		12000sa		
0045	0100	Egypt, Radio Cairo	9290sa	9315na
		9915ca		

0100 UTC - 8PM EST / 7PM CST / 5PM PST

0100	0129	Canada, Radio Canada International	6100am
0100	0130	France, Radio France Internationale	9750ca
0100	0130	Peru, Radio Bolivar	5460do
0100	0145	USA, WYFR/Family Radio Worldwide	11855ca
		17725sa	
0100	0157	China, China Radio International	9590sa
		9710sa	
0100	0200	Sat/Sun Argentina, RAE	6060am
0100	0200	Bolivia, Radio Casachun Coca	15345am
0100	0200	Bolivia, Radio Eco	4409do
0100	0200	twhfa Bolivia, Radio Fides	6155do
0100	0200	Bolivia, Radio Illimani/Radio Patria Nueva	9625do
		6025do	
0100	0200	Bolivia, Radio Nacional	5965do
0100	0200	Bolivia, Radio Pio XII	5952do
0100	0200	Bolivia, Radio San Gabriel	6080do
0100	0200	Bolivia, Radio San Jose	5580do
0100	0200	Bolivia, Radio San Miguel	4700do
0100	0200	Bolivia, Radio Santa Cruz	6135do
0100	0200	Bolivia, Radio Tacana	4782do
0100	0200	Bolivia, Radio Virgen de Remedios	4835do
0100	0200	Bolivia, Yatun Ayllu Yura/Radio Yura	4717do
0100	0200	Bulgaria, Radio Bulgaria	7300sa
0100	0200	Clandestine, Radio Republica	9490ca
0100	0200	Colombia, La Voz de tu Conciencia	6010do
0100	0200	Colombia, La Voz del Guaviare	6035do
0100	0200	Colombia, Marfil Estereo	5910do
0100	0200	Cuba, Radio Havana Cuba	5040va
		9540ca	9740sa
		11760va	11840sa
		13690sa	15230sa
0100	0200	Cuba, Radio Rebelde	5025na
0100	0200	Dominican Republic, Radio Amanecer Intl	6025do
0100	0200	Ecuador, La Voz del Napo	3280do
0100	0200	Ecuador, Radio El Buen Pastor	4815do
0100	0200	Ecuador, Radio Quito	4919do
0100	0200	Egypt, Radio Cairo	9290sa
		9915ca	9315na
0100	0200	Honduras, HRMI/ Radio Misiones Intl	3340do
0100	0200	Iran, IRIB/ VOIRI	6010sa
		6110al	7345sa
0100	0200	Mexico, Radio Educacion	6185do
0100	0200	Mexico, Radio Mil Onda Corta	6010do
0100	0200	Mexico, Radio Transcontinental de America	4800do
0100	0200	Mexico, Radio Universidad	6045do
0100	0200	Peru, La Voz de las Huarinjas	5059do
0100	0200	Peru, Ondas del Huallaga	3329do
0100	0200	Peru, Radio Altura 5014do	
0100	0200	Peru, Radio Cusco	6195do
0100	0200	Peru, Radio Genesis	4850do
0100	0200	Peru, Radio Madre de Dios	4950do
0100	0200	Peru, Radio Manantial	4986do
0100	0200	Peru, Radio Maranon	4835do
0100	0200	Peru, Radio Maranon	4835do
0100	0200	Peru, Radio Ondas del Suroiente	5120do
0100	0200	Peru, Radio Sicuani	4826do
0100	0200	Peru, Radio Tarma	4775do
0100	0200	Peru, Radio Tawantinsuyo	6174do
0100	0200	Peru, Radio Victoria	6019do
0100	0200	Peru, Radio Vision 4790do	9720do
0100	0200	Russia, Voice of Russia	9430sa
		9945sa	9810sa
0100	0200	South Korea, KBS World Radio	11810sa
0100	0200	DRM Spain, Radio Exterior de Espana	9630na
0100	0200	Spain, Radio Exterior de Espana	6055na
		6125sa	9535am
		9620sa	9765sa
0100	0200	USA, BBG/Radio Marti	6030ca
		11775ca	7365ca
0100	0200	twhfa USA, BBG/Voice of America	5890ca
		12000sa	9885ca
0100	0200	USA, EWTN/WEWN Irondale, AL	5810ca
		11870sa	
0100	0200	USA, WYFR/Family Radio Worldwide	5950na
		5985ca	7570sa
		11580sa	15255sa
0100	0200	Vatican City State, Vatican Radio	6040am
		7305am	
0100	0200	Venezuela, Radio Amazonas	4940do
0130	0200	mtwhf Ecuador, HCJB Global Voice/Quito	6050sa

SHORTWAVE GUIDE

0200 UTC - 9PM EST / 8PM CST / 6PM PST

0200	0227	Iran, IRIB/ VOIRI	6010sa	6110al	7345sa
0200	0229	Canada, Radio Canada International			9800am
0200	0230	Bolivia, Radio Casachun Coca			6075do
0200	0230	Bolivia, Radio Pio XII		5952do	
0200	0230	South Korea, KBS World Radio			9560na
0200	0245	USA, WYFR/Family Radio Worldwide			11530sa
0200	0257	China, China Radio International			9590sa
			9710sa		
0200	0257	Netherlands, R Netherlands Worldwide			6165ca
0200	0257	North Korea, Voice of Korea	11735ca	13760ca	
			15180sa		
0200	0300	Sat/Sun Argentina, RAE	6060am	15345am	
0200	0300	Bolivia, Radio Eco	4409do		
0200	0300	fa Bolivia, Radio Fides		6155do	9625do
0200	0300	Bolivia, Radio Illimani/Radio Patria Nueva		6025do	
0200	0300	Bolivia, Radio Nacional		5965do	
0200	0300	Bolivia, Radio San Gabriel		6080do	
0200	0300	Bolivia, Radio San Miguel		4700do	
0200	0300	Bolivia, Radio Santa Cruz		6135do	
0200	0300	Bolivia, Radio Tacana		4782do	
0200	0300	Bolivia, Radio Virgen de Remedios		4835do	
0200	0300	Bulgaria, Radio Bulgaria		7300sa	9400sa
0200	0300	Clandestine, Radio Republica	9490ca		
0200	0300	Colombia, La Voz de tu Conciencia		6010do	
0200	0300	Colombia, La Voz del Guaviare		6035do	
0200	0300	Colombia, Marfil Estereo		5910do	
0200	0300	Cuba, Radio Havana Cuba	5040va	6060na	
			6120ca	9540ca	9740sa
			11840sa	13690sa	15230sa
0200	0300	Cuba, Radio Rebelde		5025na	
0200	0300	Dominican Republic, Radio Amanecer Intl		6025do	
0200	0300	mtwhf Ecuador, HCJB Global Voice/Quito			6050sa
0200	0300	Ecuador, La Voz del Napo		3280do	
0200	0300	Ecuador, Radio El Buen Pastor	4815do		
0200	0300	Ecuador, Radio Quito		4919do	
0200	0300	Honduras, HRMI/ Radio Misiones Intl			3340do
0200	0300	Mexico, Radio Educacion		6185do	
0200	0300	Mexico, Radio Mil Onda Corta			6010do
0200	0300	Mexico, Radio Transcontinental de America		4800do	
0200	0300	Mexico, Radio Universidad		6045do	
0200	0300	Peru, Radio Altura	5014do		
0200	0300	Peru, Radio Maranon		4835do	
0200	0300	Peru, Radio Ondas del Suroiente		5120do	
0200	0300	Peru, Radio Sicuani		4826do	
0200	0300	Peru, Radio Tawantinsuyo		6174do	
0200	0300	Peru, Radio Victoria		6019do	9720do
0200	0300	Peru, Radio Vision	4790do		
0200	0300	Russia, Voice of Russia		9430sa	9735sa
			9945sa		
0200	0300	mtwhf Spain, Radio Exterior de Espana			9675na
0200	0300	Spain, Radio Exterior de Espana		3350ca	
			9535am	9765sa	
0200	0300	Taiwan, Radio Taiwan International		11995sa	
0200	0300	Turkey, Voice of Turkey		9410va	9650va
0200	0300	USA, BBG/Radio Marti		6030ca	7365ca
			11775ca		
0200	0300	USA, EWTN/WEWN Irondale, AL		5810ca	
			11870sa		
0200	0300	USA, WYFR/Family Radio Worldwide			11580sa
			11740ca	15255sa	
0200	0300	Venezuela, Radio Amazonas	4940do		
0230	0300	Iran, IRIB/ VOIRI	6010sa	6110al	

0300 UTC - 10PM EST / 9PM CST / 7PM PST

0300	0327	Iran, IRIB/ VOIRI	6010sa	6110al	
0300	0328	Vietnam, Voice of Vietnam/Overseas Svc			6175ca
0300	0330	Bolivia, Radio Eco	4409do		
0300	0330	Bolivia, Radio San Miguel		4700do	
0300	0330	USA, WRMI/Radio Prague relay			9955am
0300	0345	USA, WYFR/Family Radio Worldwide			9385ca
			11580sa		
0300	0355	Ecuador, Radio El Buen Pastor	4815do		
0300	0356	Romania, Radio Romania International			9765ca
			11825sa	11850sa	13650sa
0300	0357	China, China Radio International			9665sa
0300	0400	fa Bolivia, Radio Fides		6155do	9625do
0300	0400	Colombia, La Voz de tu Conciencia			6010do
0300	0400	Colombia, La Voz del Guaviare			6035do
0300	0400	Colombia, Marfil Estereo		5910do	
0300	0400	Cuba, Radio Havana Cuba	5040va	6060na	
			6120ca	9540ca	9740sa
			11840sa	13690sa	

0300	0400	Cuba, Radio Rebelde			5025na
0300	0400	Sat/Sun Ecuador, HCJB Global Voice/Quito			6050sa
0300	0400	Ecuador, Radio Quito			4919do
0300	0400	Honduras, HRMI/ Radio Misiones Intl			3340do
0300	0400	Mexico, Radio Educacion			6185do
0300	0400	Mexico, Radio Mil Onda Corta			6010do
0300	0400	Mexico, Radio Transcontinental de America			4800do
0300	0400	Mexico, Radio Universidad			6045do
0300	0400	Peru, Radio Altura	5014do		
0300	0400	Peru, Radio Victoria		6019do	9720do
0300	0400	Peru, Radio Vision	4790do		
0300	0400	Russia, Voice of Russia		9430sa	9735sa
			9945sa		
0300	0400	mtwhf Spain, Radio Exterior de Espana			9675na
0300	0400	Spain, Radio Exterior de Espana		3350ca	
			6055na	6125sa	9535am
			9765sa		9620sa
0300	0400	twhfas USA, BBG/Radio Marti		6030ca	7405ca
0300	0400	USA, EWTN/WEWN Irondale, AL			5810ca
			11870sa		
0300	0400	USA, WYFR/Family Radio Worldwide			6875ca
			9680na	9715na	9985sa
0320	0400	Vatican City State, Vatican Radio			6040am
			7305am		
0330	0400	USA, WRMI/Radio Slovakia Intl relay			9955ca

0400 UTC - 11PM EST / 10PM CST / 8PM PST

0400	0428	Vietnam, Voice of Vietnam/Overseas Svc			6175ca
0400	0430	Japan, Radio Japan NHK World			6195sa
0400	0445	USA, WYFR/Family Radio Worldwide			6875ca
			7730sa	9985sa	11740ca
					15255sa
0400	0500	fa Bolivia, Radio Fides		6155do	9625do
0400	0500	Colombia, La Voz de tu Conciencia			6010do
0400	0500	Colombia, La Voz del Guaviare			6035do
0400	0500	Colombia, Marfil Estereo		5910do	
0400	0500	Cuba, Radio Havana Cuba	5040va	6060na	
			6120ca	9540ca	9740sa
			11840sa	13690sa	15230sa
0400	0500	Cuba, Radio Rebelde		5025na	
0400	0500	Sat/Sun Ecuador, HCJB Global Voice/Quito			6050sa
0400	0500	Ecuador, Radio Quito			4919do
0400	0500	Honduras, HRMI/ Radio Misiones Intl			3340do
0400	0500	Mexico, Radio Educacion		6185do	
0400	0500	Mexico, Radio Mil Onda Corta			6010do
0400	0500	Mexico, Radio Transcontinental de America			4800do
0400	0500	Mexico, Radio Universidad		6045do	
0400	0500	Peru, Radio Victoria		6019do	9720do
0400	0500	Peru, Radio Vision	4790do		
0400	0500	Russia, Voice of Russia		9735ca	9945ca
0400	0500	mtwhf Spain, Radio Exterior de Espana			9675na
0400	0500	Spain, Radio Exterior de Espana		3350ca	
			6055na	5965sa	6125sa
			9620sa		9535am
0400	0500	twhfas USA, BBG/Radio Marti		6030ca	7405ca
0400	0500	USA, EWTN/WEWN Irondale, AL			5810ca
			11870sa		

0500 UTC - 12AM EST / 11PM CST / 9PM PST

0500	0530	Japan, Radio Japan NHK World			6195ca
0500	0545	USA, WYFR/Family Radio Worldwide			7520ca
0500	0600	Colombia, La Voz de tu Conciencia			6010do
0500	0600	Colombia, La Voz del Guaviare			6035do
0500	0600	Colombia, Marfil Estereo		5910do	
0500	0600	Cuba, Radio Havana Cuba	5040va	6060na	
			6120ca	9540ca	11760va
			15230sa		15230sa
0500	0600	Cuba, Radio Rebelde		5025na	
0500	0600	Ecuador, Radio Quito			4919do
0500	0600	Equatorial Guinea, Radio Nacional/Bata			5005do
0500	0600	Equatorial Guinea, Radio Nacional/Malabo			6250do
0500	0600	Mexico, Radio Educacion		6185do	
0500	0600	Mexico, Radio Mil Onda Corta			6010do
0500	0600	Mexico, Radio Transcontinental de America			4800do
0500	0600	Peru, Radio Victoria		6019do	9720do
0500	0600	Peru, Radio Vision	4790do		
0500	0600	DRM Spain, Radio Exterior de Espana			9780eu
0500	0600	mtwhf Spain, Radio Exterior de Espana			9675na
0500	0600	mtwhf Spain, Radio Exterior de Espana			12035eu
0500	0600	Spain, Radio Exterior de Espana		3350ca	
			5965sa	6055na	11895me

0500 0600 twhfas USA, BBG/Radio Marti 6030ca 7405ca
 0500 0600 USA, EWTN/WEWN Irondale, AL 7555ca
 11870sa
 0500 0600 USA, WYFR/Family Radio Worldwide 5850ca
 9505ca 9715na 9985eu
 0530 0600 Iran, IRIB/ VOIRI 13710eu 15330sa

0600 0700 Cuba, Radio Rebelde 5025na
 0600 0700 Ecuador, Radio Quito 4919do
 0600 0700 Equatorial Guinea, Radio Nacional/Bata
 5005do
 0600 0700 Equatorial Guinea, Radio Nacional/Malabo
 6250do
 0600 0700 Mexico, Radio Educacion 6185do
 0600 0700 Mexico, Radio Mil Onda Corta 6010do
 0600 0700 Mexico, Radio Transcontinental de America
 4800do
 0600 0700 Peru, Radio Victoria 6019do 9720do
 0600 0700 Peru, Radio Vision 4790do
 0600 0700 South Korea, KBS World Radio 6045eu
 0600 0700 DRM Spain, Radio Exterior de Espana 9780eu

0600 UTC - 1AM EST / 12AM CST / 10PM PST

0600 0627 Iran, IRIB/ VOIRI 13710eu 15330sa
 0600 0657 China, China Radio International 15135eu
 0600 0700 Colombia, La Voz de tu Conciencia 6010do
 0600 0700 Colombia, La Voz del Guaviare 6035do
 0600 0700 Colombia, Marfil Estereo 5910do

MT SHORTWAVE STATION RESOURCE GUIDE

Afghanistan, Radio Afghanistan www.rta.org.af
 Albania, Radio Tirana <http://rtsh.sil.at/>
 Angola, Angolan National Radio www.rna.ao/
 Anguilla/Caribbean Beacon/Univ Network..... www.worldwideuniversitynetwork.com/
 Argentina, RAE www.radionacional.gov.ar
 Australia, ABC NT Alice Springs..... www.abc.net.au/radio/
 Australia, ABC NT Katherine..... www.abc.net.au/radio/
 Australia, ABC NT Tennant Creek www.abc.net.au/radio/
 Australia, HCJB Global Australia www.hcjb.org.au
 Australia, Radio Australia www.abc.net.au/ra/
 Austria, AWR Europe www.awr2.org/
 Bahrain, Radio Bahrain www.radiobahrain.fm/
 Belarus, Radio Station Belarus www.radiobelarus.tvr.by/eng/
 Belgium, TDP Radio www.airtime.be/schedule.html
 Belgium, TDP Radio/Disco Palace www.airtime.be/schedule.html
 Bhutan, Bhutan Broadcasting Svc..... www.bbs.com.bt
 Bulgaria, Radio Bulgaria www.bnr.bg/
 Canada, Bible Voice Broadcasting www.biblevoice.org/
 Canada, CBC Northern Quebec Svc..... www.cbc.ca/north/
 Canada, CFRX Toronto ON www.cfrb.com
 Canada, CFVP Calgary AB www.classiccountryam1060.com
 Canada, CKZN St Johns NF www.cbc.ca/listen/index.html
 Canada, CKZU Vancouver BC www.cbc.ca/bc
 Canada, Radio Canada International www.rcinet.ca/
 China, China Radio International www.cri.cn
 China, Haixa zhi Sheng/VO Strait..... www.vos.com.cn
 Clandestine, Sudan Radio Service/SRS www.sudanradio.org
 Croatia, Voice of Croatia..... www.hrt.hr/
 Cuba, Radio Havana Cuba www.radiohc.cu/
 Egypt, Radio Cairo www.ertu.org
 Equatorial Guinea, Radio Africa..... www.radiopanam.com/
 Equatorial Guinea, Radio Africa 2..... www.radiopanam.com/
 Equatorial Guinea, Radio East Africa www.radiopanam.com/
 Equatorial Guinea, Radio East Africa/Malabo
 www.radiopanam.com/
 Ethiopia, Radio Ethiopia www.ertagov.com
 Ethiopia, Radio Ethiopia/National Program www.ertagov.com
 France, Radio France Internationale..... <http://rfienglish.com>
 Germany, AWR Europe..... www.awr2.org/
 Germany, Deutsche Welle www.dw-world.de/
 Germany, Pan American Broadcasting www.radiopanam.com/
 Germany, TWR Europe..... www.twr.org
 Guam, AWR/KSDA www.awr2.org/
 Guam, TWR Asia/KTWR <http://nea.ktwr.net/>
 India, All India Radio/Aizawl..... www.allindiaradio.org/
 India, All India Radio/Aligarh www.allindiaradio.org/
 India, All India Radio/Bengaluru..... www.allindiaradio.org/
 India, All India Radio/Bhopal..... www.allindiaradio.org/
 India, All India Radio/Chennai www.allindiaradio.org/
 India, All India Radio/Delhi www.allindiaradio.org/
 India, All India Radio/External Svc..... www.allindiaradio.org/
 India, All India Radio/Gangtok www.allindiaradio.org/
 India, All India Radio/Gorakhpur..... www.allindiaradio.org/
 India, All India Radio/Guwahati..... www.allindiaradio.org/
 India, All India Radio/Hyderabad www.allindiaradio.org/
 India, All India Radio/Imphal..... www.allindiaradio.org/
 India, All India Radio/Itanagar www.allindiaradio.org/
 India, All India Radio/Jaipur..... www.allindiaradio.org/
 India, All India Radio/Jeyapore..... www.allindiaradio.org/
 India, All India Radio/Kolkata..... www.allindiaradio.org/
 India, All India Radio/Kurseong www.allindiaradio.org/
 India, All India Radio/Lucknow www.allindiaradio.org/
 India, All India Radio/Mumbai..... www.allindiaradio.org/

India, All India Radio/Panaji, Goa..... www.allindiaradio.org/
 India, All India Radio/Port Blair www.allindiaradio.org/
 India, All India Radio/Radio Kashmir..... www.allindiaradio.org/
 India, All India Radio/Shillong www.allindiaradio.org/
 India, All India Radio/Shimla www.allindiaradio.org/
 India, All India Radio/Thiruvananthapuram..... www.allindiaradio.org/
 Indonesia, Voice of Indonesia www.voi.co.id
 Iran, IRIB/ VOIRI www.irib.ir/English/
 Italy, IRRS-Shortwave www.nexus.org
 Italy, IRRS-Shortwave/Euro Gospel Radio..... www.nexus.org
 Italy, IRRS-Shortwave/Overcomer Ministry..... www.nexus.org
 Japan, Radio Japan NHK World www.nhk.or.jp/english/
 Kuwait, Radio Kuwait..... www.media.gov.kw/
 Malaysia, RTM Kajang/Traxx FM www.traxxfm.net/index.php
 Malaysia, RTM/Voice of Malaysia..... www.rtm.gov.my
 Mali, ORTM/Radio Mali..... www.ortm.ml
 Micronesia, The Cross Radio/Pohnpei www.pmapacific.org/
 Nepal, Radio Nepal www.radionepal.org/
 Netherlands, R Netherlands Worldwide www.radionetherlands.nl/
 Nigeria, Voice of Nigeria..... www.voiceofnigeria.org
 Oman, Radio Sultanate of Oman www.oman-tv.gov.om
 Pakistan, PBC/Radio Pakistan..... www.radio.gov.pk
 Palau, T8WH/ WHRI www.whr.org/
 Philippines, PBS/ Radyo Pilipinas..... www.pbs.gov.ph/
 Poland, Polskie Radio Warsaw www.polskieradio.pl
 Romania, Radio Romania International www.rri.ro/
 Russia, Voice of Russia <http://english.ruvr.ru/>
 Saudi Arabia, BSKSA/External Svc..... www.saudiradio.net/
 Serbia, International Radio Serbia..... www.glassrbije.org
 South Africa, AWR Africa www.awr2.org/
 South Africa, Channel Africa..... www.channelafrica.org
 South Africa, CVC 1 Africa Radio..... www.1africa.tv
 South Africa, RTE Radio Worldwide www.rte.ie/radio1/
 South Africa, South African Radio League..... www.sarl.org.za
 South Korea, KBS World Radio www.worldkbs.co.kr
 Spain, Radio Exterior de Espana www.ree.rne.es/
 Sri Lanka, SLBC www.slbc.lk
 Swaziland, TWR Africa www.twrafrica.org
 Syria, Radio Damascus..... www.rtv.gov.sy/
 Taiwan, Radio Taiwan International <http://english.rti.org.tw/>
 Thailand, Radio Thailand World Svc..... www.hsk9.org/
 Turkey, Voice of Turkey..... www.trt-world.com
 Uganda, Dunamis Shortwave www.biblevoice.org/stations/east-africa
 UK, BBC World Service..... www.bbc.co.uk/worldservice/
 USA, American Forces Network/AFRTS..... <http://myafn.dodmedia.osd.mil/>
 USA, BBG/Voice of America www.voanews.com
 USA, BBG/Voice of America/Special English www.voanews.com
 USA, EWTN/WEWN Irondale, AL www.ewtn.com/
 USA, FBN/WTJC Newport NC www.fbnradio.com/
 USA, KNLS Anchor Point AK [/www.knls.org/](http://www.knls.org/)
 USA, WBCQ Monticello ME www.wbcq.com/
 USA, WHRI Cypress Creek SC www.whr.org/
 USA, WINB Red Lion PA www.winb.com
 USA, WRMI/Radio Prague relay www.wrmi.net/
 USA, WRMI/Radio Slovakia Intl relay..... www.wrmi.net/
 USA, WRNO New Orleans LA www.wrnradio.com
 USA, WTWW Lebanon TN www.wtww.us/
 USA, WWCR Nashville TN..... www.wwcr.com
 USA, WWRB Manchester TN www.wwrb.org/
 USA, WYFR/Family Radio Worldwide..... www.familyradio.com/
 Vatican City State, Vatican Radio..... www.vaticanradio.org/
 Vietnam, Voice of Vietnam/Overseas Svc..... www.vov.org.vn
 Zambia, CVC Radio Christian Voice..... www.voiceafrica.net
 Zambia, ZNBC/Radio Two..... www.znbc.co.zm



DoD Challenges and Changes

❖ Milcom Spectrum Holes

I have written often over the years about a set of frequencies in the 225-400 MHz range that I call "spectrum holes." In brief, a spectrum hole is a legitimate frequency for assignment based on current channel spacing and the Department of Defense bandplan, but for which no activity/current assignment has ever been heard/found. That is a spectrum hole.

If you are interested in exploring the world of 225-400 MHz spectrum holes, I have listed my current list of 123 frequencies below for those who want a monitoring challenge. And if you hear something or know something about one of these frequencies, I would appreciate an email at the address in the masthead.

226.250 234.175 236.925 239.075 244.675
244.925 245.075 248.525 248.775 249.675
249.725 250.375 250.475 250.575 250.875
251.625 251.675 252.375 252.450 252.875
253.175 253.425 254.625 254.875 255.025
255.325 255.475 255.525 255.675 256.425
256.975 258.025 258.475 258.525 259.075
259.625 259.775 264.475 265.375 265.475
265.625 265.875 266.825 266.925 267.025
267.125 267.225 267.325 267.950 267.975
268.325 269.875 269.925 270.075 270.425
270.475 270.925 271.050 271.775 271.925
274.225 274.275 274.925 275.075 275.625
275.725 276.175 276.725 276.775 276.875
277.475 277.575 277.675 277.775 277.875
277.975 278.525 279.325 293.075 293.575
297.925 305.975 306.275 306.475 306.525
306.675 307.825 307.925 308.375
308.675 310.025 310.175 310.275 310.775
310.875 311.075 311.875 316.475 318.425
318.625 318.775 319.075 324.225 326.375
326.425 342.625 346.475 346.575 348.075
349.875 350.175 358.775 360.175 361.525
365.675 365.975 367.575 368.925 369.375
375.975 377.475 377.750 378.075

❖ New Names for old DoD Bases

The Base Realignment and Closure (or BRAC) is a process of the United States federal government directed at the administration and operation of the Armed Forces, which is used by the United States Department of Defense (DoD) and Congress to close excess military installations. This process allows the military to realign their property inventory and reduces expenditures on operations and maintenance.

More than 350 installations have been closed in five BRAC rounds: 1989, 1991, 1993, 1995 and the most recent round of BRAC was completed and entered into law in November 2005.

In accordance with congressional law implementing the recommendations of the last BRAC, the legislation ordered the consolidation of adjoining but separate facilities into a single joint base. There were 12 joint bases formed in the United States as a result of this law.

So, the next time you write up a frequency listing for any of these bases listed below, here are the new names you should use or need to research.

- Joint Base Anacostia-Bolling, District of Columbia, is a 905 acre military installation, located in southeast Washington, D.C., that was established on October 1, 2010, in accordance with the congressional BRAC 2005 legislation. This legislation ordered the consolidation of Naval Support Facility Anacostia (NSF) and Bolling Air Force Base (BAFB), which were adjoining, but separate military installations, into a single joint base. Coast Guard Station Washington, D.C., is located on the post, next to the Capitol Cove Marina. The only aeronautical facility at the base is a helipad (ICAO ID: KBOF).



Air Force One takes off over C-130 airfield assigned to the Air Force Reserve's 440th Airlift Wing. (DoD Photo)

- Joint Base Andrews-Naval Air Facility Washington, Maryland, is a military facility located in Prince George's County, Maryland. The facility is under the jurisdiction of the United States Air Force 11th Wing, Air Force District of Washington (AFDW). The facility is an amalgamation of the United States Air Force Andrews Air Force Base and the United States Navy Naval Air Facility Washington which were merged on October 1, 2009. Andrews (ICAO ID: KADW) is widely known for serving as the home base of two Boeing VC-25A aircraft that serve the President of the United States.

- Joint Base Charleston, South Carolina, is a military facility located in North Charleston, South Carolina. The facility is under the jurisdiction of the United States Air Force 628th Air Base Wing, Air Mobility Command (AMC). The facility is an amalgamation of the United States Air Force Charleston Air Force Base and the United States Navy Naval Support Activity Charleston which were merged on October 1, 2010.

A joint civil-military airport, JB Charleston (ICAO ID: KCHS) shares runways with Charleston International Airport for commercial airline aircraft operations on the south side of the airfield and general aviation aircraft operations on the east side.

- Joint Base Elmendorf-Richardson, Alaska, is a military facility adjacent to Anchorage, the largest city in Alaska. It is an amalgamation of the former United States Air Force Elmendorf Air Force Base and the United States Army Fort Richardson. The facilities, which have always shared the same relative geographic position, were officially combined in 2010. The mission of the base is to support and defend U.S. interests in the Asia Pacific region and around the world by providing units who are ready for worldwide air power projection and a base that is capable of meeting PACOM's theater staging and throughput requirements.

Joint Base Elmendorf-Richardson (ICAO ID: PAED) is the home of the Headquarters, Alaskan Command (ALCOM), Alaskan NORAD Region (ANR), Joint Task Force-Alaska (JTF-AK), Eleventh Air Force (11 AF), the 673d Air Base Wing, the 3rd Wing, the 176th Wing and other tenant units.

- Joint Base Langley-Eustis, Virginia, is a military facility located in Hampton and Newport News, Virginia. The facility is under the jurisdiction of the United States Air Force 633rd Air Base Wing, Air Combat Command (ACC). The facility is an amalgamation of the United States Air Force's Langley Air Force Base (ICAO ID: KLFJ) and the United States Army's Fort Eustis which were merged on October 1, 2010. Unlike other joint bases that share common perimeters, these two military base components are geographically separated by 17 miles.
- Joint Base Lewis-McChord, Washington, is a military facility located 9.1 miles south-southwest of Tacoma, Washington.

The facility is under the jurisdiction (installation management functions) of the United States Army Joint Base Garrison, Joint Base Lewis-McChord. The facility is an amalgamation of the United States Army Fort Lewis and the United States Air Force McChord Air Force Base (ICAO ID: KTCM) which were merged on February 1, 2010.

- Joint Base McGuire-Dix-Lakehurst, New Jersey, is a military facility located 18 miles southeast of Trenton, New Jersey. The facility is under the jurisdiction of the United States Air Force 87th Air Base Wing. The facility is an amalgamation of the former United States Air Force McGuire Air Force Base, the United States Army Fort Dix and the United States Navy Naval Air Engineering Station Lakehurst (ICAO ID: KWRI/KNEL), which were merged on October 1, 2009.
- Joint Base Myer-Henderson Hall, Virginia, is a military base which is made up of Fort Myer, Fort McNair, and Henderson Hall (US Marine Corps) that were merged on October 1, 2009. It is commanded by the United States Army.
- Joint Base Pearl Harbor-Hickam, Hawaii, is a military facility adjacent to Honolulu, Hawaii. It is an amalgamation of the former United States Air Force Hickam Air Force Base and the United States Navy Naval Base Pearl Harbor, which were merged in 2010. It is part of Navy Region Hawaii and provides Navy and joint operations Base Operating Support that is capabilities-based and integrated. As part of Pacific Air Forces, the United States Air Force 15th Wing based at this joint base (ICAO ID: PHNL) provides strategic and tactical airlift capability to PACAF and Air Mobility Command operating the C-17 Globemaster III.
- Joint Base San Antonio, Texas, is a military facility located in San Antonio, Texas. The facility is under the jurisdiction of the United States Air Force 502d Air Base Wing, Air Education and Training Command (AETC). The facility is an amalgamation of the United States Army Fort Sam Houston, the United States Air Force Randolph Air Force Base and Lackland Air Force Base, which were merged on October 1, 2010
- Joint Expeditionary Base Little Creek-Fort Story, Virginia is a military base that is located in the Virginia Beach area which is made up of Fort Story and Naval Amphibious Base Little Creek. It is commanded by the United States Navy.
- Joint Region Marianas is a military facility located on the island of Guam. The facility is under the jurisdiction of the United States Navy. The facility is an amalgamation of the United States Navy Naval Base Guam and the United States Air Force Andersen Air Force Base which were merged on October 1, 2010.

❖ Milcom Frequency Updates/Changes

Below is another round of aeronautical frequency changes/updates from the Federal Aviation Administration. I hope to pick back up on our Air Route Traffic Control Center listings in the April issue of *Monitoring Times* if research time and space permit.

46.900	Muldrow AHP (KHYM) OK National Guard Operations
49.700	NAS Corpus Christi (Truax Field) TX Army Operations (AA5XC aka Xray Charlie callsign)
118.200	Gallatin Field (KBZN) MT Tower
118.450	Barnstable Muni (Boardman/Polando Field) (KHYA) Ground Control (ex-121.900)
118.600/350.300	Des Moines IA Approach/Departure Control (Secondary)
118.700	Waynesville-St. Robert Regional Forney (KTBN) MO D-ATIS
119.300	Anchorage ARTCC (ZAN) Johnstone RCAG AK (no UHF pair)
121.600	Glacier Park International-Kalispell (KGPI) MT Ground Control
121.800	Gallatin Field (KBZN) MT Ground Control
121.900	Augusta Regional at Bush Field Airport (KAGS) GA Ground Control/Clearance Delivery
122.025	Casper Radio (Johnson County Airport KBYG WY RCO)
122.200	Juneau Radio (Valdez RCO 7KA AK RCO)
122.475	Gainesville Radio (Gainesville-Gators KGNV FL RCO) (ex-123.650)
122.500	Great Falls Radio (Kalispell City Airport KS27 MT RCO)
123.900/307.150	Des Moines IA Departure Control (Primary)
124.200/336.400	Oke City Approach/Departure Control OK
125.250/235.975	Kansas City ARTCC (ZKC) Chillicothe RCAG MO (ex-381.500)

125.250	Tri Cities Approach/Departure Control TN/VA (ex-128.675)
127.500/316.050	Atlanta ARTCC (ZTL) Athens RCAG GA
128.350/239.250	Salt Lake City ARTCC (ZLC) Ashton RCAG ID (ex-381.600)
128.425	Cape Cod CGAS (KFMH) MA Tower (ex-121.000)
128.600/306.975	Miami Tracon FL Approach/Departure Services (ex-255.600)
132.475/291.100	Atlanta Tracon GA (A80) Approach/Departure Services (Athens Ben Epps Airport)
132.600/269.350	Seattle ARTCC (ZSE) Wallula and Yakima RCAG WA
132.900	Rocky Mountain Metropolitan (KBJC) CO Clearance Delivery
134.700/307.200	Potomac Tracon (PCT) Approach/Departure Control
135.200/360.700	Des Moines IA Approach Control (Primary)
139.000	NAS Corpus Christi (Truax Field) TX Army Operations (AA5XC aka Xray Charlie callsign) (ex-139.200)
139.425	Muldrow AHP (KHYM) OK National Guard Operations
140.225	Hanchey AHP (KHEY) AL (Fort Rucker) Tower (ex-141.800)
140.250	Muldrow AHP (KHYM) OK AWOS
142.550	Hanchey AHP (KHEY) AL (Fort Rucker) Ground Control (ex-149.600)
149.625	McEntire ANGB (KMMT) SC Pilot-to-Dispatcher (PTD)
227.200	Muldrow AHP (KHYM) OK National Guard Operations
236.600	Cape Cod CGAS (KFMH) MA Tower (deleted no replacement listed by FAA)
269.400	Anchorage ARTCC (ZAN) Middleton Island RCAG AK (maybe paired with 133.600)
288.500	Ellington Field (KEFD) TX ANG Operations/Command Post (ex-261.800)
339.700	NAS Corpus Christi (Truax Field) TX Army Operations (AA5XC aka Xray Charlie callsign)
353.850	General Downing - Peoria International Airport (KPIA) IL Tower (ex-252.900)
372.200	Cape Cod CGAS (KFMH) MA PTD (deleted no replacement listed by FAA)

❖ New US Air Force Callsigns

Here is some information on two new USAF callsigns, both from Scott Air Force Base in Illinois.

ILLINI	KC-135R	126 ARW/108ARS - IL Air National Guard
		Pronounced eh-line-eye
SPRINT	C-21A	375 AMW - C-21A Flying Training Unit (FTU)
		This unit used to be at Keesler AFB until last year when it moved to Scott.

Also, all of the FAA/USAF flight check aircraft are now under the OPCON/TACON of the 375 AMW based at Scott AFB. They are known as 375 OG/Det. 1.

❖ Navy MARS Changes Frequencies

Finally, we have received official notice from the Chief of Navy/Marine Corps MARS that they are using a new frequency matrix for their day-to-day operations.

According to the ALNAV/MARCORMARS message: "A new frequency matrix and HF freq and power text file have been uploaded to the frequencies tab on navymars.org.

"This reflects the joint efforts of Navy-Marine Corps Spectrum Office, Pacific and HQ NAVY/MARCORMARS to consolidate all HF frequency records from over 700 down to a total of 175 records. All frequencies are now authorized for United States and Possessions for the 3k00J8E, 2K80J3E and 1K24F1B modes at a 1000 watt power output level.

"Changes were made in several places, most notably just above the 80 meter amateur band. Since assignments were so closely bunched, I asked, and NMCSO PAC obtained, additional frequencies higher in the 4 MHz range to replace some of the closely bunched ones. I have reassigned all old allocations to the new frequencies."

According to the message, two additional frequencies have been requested, but have still not been approved by NTIA so are not yet assigned and the changes should have been implemented immediately.

All reports of the new Navy/Marine Corps MARS frequency activity are requested and you can send them to our address in the masthead.

Until next time, 73 and good hunting.



The AM Dial Stations Coming and Going

You'll notice in the "Station Report" sidebar quite a few new stations (especially in Canada) – and quite a few old stations going away. It's hard to explain why, while some station operators are giving up and shutting down their operations, others are putting new stations on the air.

In many cases, the stations going away were limited to low power, especially at night. The FCC will no longer license daytime-only stations. Many of the new Canadian stations are in major cities where the FM band is now completely full; new FM stations are not possible.

❖ Montreal 690/940

I've been spending a lot of space in this column covering these two frequencies. There are two good reasons for that. For one: while these frequencies are open, they represent a golden opportunity for logging some interesting signals that would normally be buried under the Montreal signals. For another, when they are re-activated, these stations should be viable targets for DXers across most of North America. The Canadian Radio-Television and Telecommunications Commission has named the winners – the firms which will be using these frequencies.

The best frequency was 690. Lower frequencies provide better local coverage, and 690 is relatively free of nighttime interference. Every applicant requested 690. CKGM won it. Their English-language all-sports operation will move from 990 to 690.

Next was 940. The daytime coverage is not quite as good as 690, but it's pretty decent, and while the nighttime interference levels are worse than 690, they aren't particularly bad. It's a "Class A" frequency, which means the nighttime antenna need not be particularly directional, which in turn will make the station less expensive to build and operate, and will provide better coverage in the Montreal area. 7954689 Canada Inc. asked for 690, but was willing to accept 940 instead; they'll be operating a French-language news/talk station on this frequency.

Since CKGM-990 was granted permission to move to 690, their old 990 frequency could be awarded to a third applicant. That applicant was Dufferin Communications. They, too, had requested 690 but were willing to accept 990. Dufferin will operate a French-language station serving Montreal's gay community. (similar to an FM station launched this year in Toronto)

So, as DXers, how long do we have? There's nothing official. CKGM has agreed to lease their 990 kHz transmission facility to



An FM translator antenna on Pinnacle Hill, Rochester, NY

Dufferin; Dufferin could begin broadcasting immediately, except that CKGM isn't likely to let them use 990 until CKGM's new 690 facility is ready! CKGM will be using one of the towers at the 990 site for their new operation on 690. They'll need to order and install a tuning network and combiner to allow the two stations to share the tower. I would estimate the new 690 facility should be ready mid-summer (but that's a wild guess).

690 had been previously used by French-language all-news station CINF, and before that, the CBC's French-language *Premiere Chaine* station CBF. The CBF transmission facility east of Montreal was torn down years ago. I'm told the CINF facility is still standing, but CKGM is unwilling to use it. As noted above, it will take a few months to order and install the necessary equipment to operate on 690 from the existing 990 facility.

As for 940, I have no idea.. This frequency was also previously used by two stations: the CBC's English-language Radio One station CBM, and English all-news station CINW. CBM had shared its facility with CBF (so both facilities have been torn down), and CINW shared its with CINF. If the new licensee is willing to lease the old CINW facility, 940 could be on early this year. If they end up sharing towers with some other station, I would expect the reappearance of 940 later this year. If they have to build a completely new facility, it could take two years or more.

On a vaguely-related Canadian subject, last time I noted CBE-1550 Windsor was supposed to go off the air at deadline but had not yet done so. In the time it took last December's column to travel through the Internet to *MT* Headquarters in North Carolina, CBE indeed went permanently silent.

❖ And Across the Pond...

The BBC has announced they will be silencing a number of AM frequencies and, eventually, their powerhouse longwave signal on 198 kHz. The longwave transmitters will remain on the air but will not be repaired if they fail. (Reportedly, VERY expensive tubes are used.) 198 has been a very DXable frequency for American listeners; we'll miss it.

They will also be silencing BBC Local Radio stations on AM, where existing FM transmitters cover the same area. I believe fourteen frequencies for ten stations are affected. These are all relatively low power and not likely to be DXable from North America without long Beverage antennas.

❖ More New Stations

We have three new stations on the air this time. KGG5 1340 in Kansas carries country music and agricultural information. CIRA-5 1350 in Quebec is reported testing with the same French-language children's programming as nearby CJEU-1670. It will eventually relay the French religious programming of CIRA-FM 91.3 Montreal. Yes, the -5 is part of the station's callsign; it's the fifth of five stations relaying CIRA. (The other four are FM.) KKMP and a co-owned FM station carry "island music," not necessarily just of the island of Saipan.

A new station has been authorized in Wasilla, Alaska on 880 kHz. The permittee is a "Steve King." It's not clear whether this is the same Stephen King responsible for a number of well-received suspense novels. (But it probably is: The author already owns three stations in Maine.)

❖ Non-Commercial Station = No Commercials

A radio or TV station may opt for non-commercial status. Non-commercial stations are exempt from license and application fees. Certain TV channels and FM frequencies below 92 MHz are reserved for the exclusive use of non-commercial operations. In return for

these advantages, non-commercial stations are not allowed to sell airtime for commercial announcements. That all seems fairly simple and straightforward, doesn't it?

Apparently a South Carolina non-commercial broadcaster wasn't quite so sure. Network of Glory owns five non-commercial FM stations. The Network petitioned the FCC for permission to air commercials on their non-commercial stations. They claim that the poor economy has made it difficult to obtain grants and underwriting; they're finding it difficult to finance the operation of their stations.

The Network's stations are relatively new. All five were applied for in a 2007 filing window. The oldest, WAKP in Georgia, went on the air in July 2010; the rest came on over the next ten months.

The FCC isn't buying their argument. Section 399B of the Communications Act prohibits the broadcast of commercials by non-commercial stations. The Commission cannot waive a provision of the Communications Act. Only Congress can do that. They also note that tight finances are hardly unusual among non-commercial stations.

Listeners/viewers often do hear material that sounds a lot like commercials on non-commercial stations. Stations may air "underwriting" announcements, acknowledging contributions and contributors. Stations may indicate where contributors' businesses are located and indicate what type of business is conducted. Non-commercial stations may not compare contributors' products/services with those of other firms, and they may not issue a "call to action," asking listeners to buy something from contributors.

❖ FCC Still not Buying

In April 2011, a new FM station was launched in Detroit. "Oasis 104.7" was carried on the HD2 subchannel of WGPR-107.5. The station was also relayed on FM translator W284BQ-104.7. Since almost nobody has an HD radio... of course, nearly all Oasis' listeners were listening to the translator.

For regular radio stations, the FCC has specific engineering methods that predict interference, or the lack thereof. If a new station complies with the methods spelled out in the rules, there will be, by definition, no interference. As long as the new station is operated according to its license, it will be allowed to continue.

These rules don't apply to translators. Translators are a "secondary" service; they may not cause any interference, even if the standard engineering rules show that interference shouldn't exist.

When W284BQ came on the air, there was interference. Listeners in Ypsilanti and Taylor, Michigan were listening to rock station

WIOT Toledo on the same frequency – at least, they were until W284BQ came along. W284BQ installed a directional antenna, reducing their signal in the direction of these towns. It reduced the interference, but it didn't eliminate it. The FCC requires that there be no interference from translators. Oasis 104.7 had to try something else.

They tried smartphones. They agreed to provide free smartphones to the nine people who were still complaining of interference. These phones could be used to listen to WIOT online, using the iheartradio.com app. Oasis would pay for both the phones themselves and the airtime charges.

But while the listeners were OK with the arrangement, WIOT and the FCC weren't. WIOT wasn't convinced Oasis would continue to pay for the airtime indefinitely; they worried the wireless network might go down; they didn't want the listeners to lose WIOT if the station decided to stop participating in iheartradio.com; and they noted that some material (including commercials) aired over WIOT's transmitter cannot be streamed online (for legal reasons).

The FCC added a few concerns. They noted WIOT had only forwarded complaints from listeners located within the station's "protected contour." WIOT is entitled to protection from translator interference beyond that contour. The Commission asked who would pay for repair or replacement if one of the smartphones was lost or damaged. And they worried about the Commission's ability to police this kind of agreement.

None of the parties brought up a concern that I'd certainly have if I was with WIOT: what about people who don't listen to WIOT right now, but who might discover the station while scanning the dial and decide they like it? These listeners won't find WIOT, and won't know they might like it, if they can't hear it due to the W284BQ interference.

The Commission ordered W284BQ to shut down. The station is attempting to remedy the problem by changing frequency to 93.5.

❖ Mailbag

Last time, I asked if anyone had had any of their local AM stations shut down recently. M.L. Rogers wrote from my own backyard (Chattanooga, Tennessee) with one I really shouldn't have forgotten about!

"The first commercial radio station in Chattanooga, TN went off the air around June 1, 2011. WDOD-AM 1310 shut down as the station's building and land were sold to the surrounding prep school. WDOD went back to 1925 and was the long-time CBS affiliate for the area. In recent years, it used a "beautiful music" format ('30s through '50s standards) and carried Air America for a brief time. In the last few years, it retransmitted syndicated programming from Fox Sports on a very weak signal."



A Thales UHF digital TV transmitter. (I'll bet you thought it would be bigger!)

❖ 'Til Next Month

It's your last chance to log exotic DX on 690 and 940, before the new Montreal powerhouses sign back on the air. What are you hearing on these frequencies? Write me at 7540 Highway 64 West, Brasstown NC 28902-0098, or by email to dougsmith@monitoringtimes.com. Good DX!

URLs in this month's column:

<http://americanbandscan.blogspot.com>

My DX blog.

[http://en.wikipedia.org/wiki/WDOD_\(AM\)](http://en.wikipedia.org/wiki/WDOD_(AM)) One of a number of defunct AM stations

http://hraunfoss.fcc.gov/edocs_public/attachmatch/DA-11-1727A1.txt FCC refuses to allow smartphones to substitute for radio

http://hraunfoss.fcc.gov/edocs_public/attachmatch/DA-11-1684A1.txt FCC refuses to allow non-commercial stations to air commercials

www.bbc.co.uk/news/entertainment-arts-15165926 BBC to silence some AM transmitters

www.zoneradio.com/AuthorStephenKing's radio stations in Maine

BANDSCAN STATION REPORT

NEW STATIONS

New Stations on the Air:

Garden City, Kansas	1340	KGGS	1,000/880 ND
Gatineau, Quebec	1350	CIRA-5	1,000/100 ND
Garapan, Saipan	1440	KKMP	1,100/1,100 ND

Permits Granted for New Stations:

Wasilla, Alaska	880	210/210 ND
Reno, Nevada	1180	7,500/950 DA-N
Mississauga, Ontario	960	2,000/280, local news/talk
Fritch, Texas	1570	12,000/1,000 DA-2
Midland, Texas	1550	50,000/300 DA-1

Applications for New Stations:

Calgary, Alberta	1670	5,000/1,000 ND, ethnic
Tyonek, Alaska	1360	20,000/20,000 ND
Star, Idaho	1020	10,000/460 DA-N
Ottawa, Ontario	1630	1,000/1,000 ND, ethnic
Grants Pass, Oregon	830	5,000/1,000 DA-N

CHANGES

Frequency & Location Changes on the Air:

Kalamazoo, Michigan	1440	WKPR	from 1420; 2,700/24 ND
---------------------	------	------	------------------------

Frequency & Location Changes Requested:

Sylva, North Carolina	540	WRGC	from 540; 5,000/140 ND
Memphis, Tennessee	830	KOTC	from Kennett, Mo.; 3,500 ND-D

Both of these reflect expired permits which have been reinstated.

Stations Deleted:

Montevallo, Alabama	880	(application for new station dismissed)
Casa Grande, Arizona	650	(permit for new station canceled)
Kispixio, B.C.	990	CBTD (wants to go to 91.3 FM)
Pemberton, B.C.	1240	CBXK (wants to go to 91.5 FM)
Young Harris, Georgia	770	WYHG
Ottawa, Ontario	1630	CHYW (low-power station will be displaced if application for new station is granted)

ND: non-directional

ND-D: non-directional, only operates daytime

DA-N: directional at night only

DA-D: directional during daytime only

DA-2: directional all hours, two different patterns

DA-3: directional day, night and critical hours, three different patterns



Getting Your Directions Straight

Air Traffic Controllers call out directions and distances to pilots in a variety of ways depending on the circumstance. All are there for you to hear on your scanner.

Here, we will talk some about that and True and Magnetic North, airport distance and direction, VOR Radials, Clock Position and Distance, Runway numbering, and more. Let's take a look!

❖ True and Magnetic North

Somewhere in our schooling, most of us were taught about True North and Magnetic North. It can seem simple enough but still can be confusing when applying it to the aero comms we hear on our scanners.

The difference in degrees between True and Magnetic (magnetic declination) vary from one geographical area on earth to another.

In this graphic for inland Northern California, the angular difference between True North (vertical arrow) and Magnetic North (angled arrow) is 14.4 degrees.

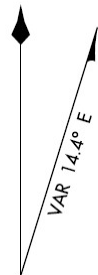

To find such a graphic for your area, go to www.airnav.com/

[airports/](http://www.airnav.com/airports/) and enter the airport code for an airport near you. When it comes up, scroll down to the "Airport diagram" on the right and click on the link "Download PDF." You will find it there.

If you have a pocket compass and this interests you, place it on a printout of your local airport diagram and away from any ferrous (iron, steel) metals. Rotate the compass body until the North-pointing end of the needle points to "N." Then, move the printout to align the Magnetic North arrow (smaller arrowhead) to the compass needle. At this point, the other chart arrow (large arrowhead) will point toward True North.

Pilots have a long history of working with magnetic compasses. To see a nice variety of airplane compass images, go to <http://images.google.com> and enter "airplane compass" (with or without the quotes).

❖ Heading / Bearing

Here are a couple terms that are helpful to know:

- "Heading" is the direction in degrees clockwise from Magnetic North that the aircraft is pointing – but not necessarily traveling if there is a crosswind. If it is referenced to the less common True North, the word "true" must be added. Ex: "True Heading 210" or "Two One Zero True."
- "Bearing" is the direction in degrees clockwise from Magnetic North to the intended destination or an intermediate point like a VOR station. It

is independent from the aircraft's direction of travel.

❖ Airport Distance and Direction

Let's say you are hearing a Control Tower or hearing an aircraft landing at an airport and you want to know how far and in what direction it might be from your listening location, go to www.airnav.com/airports/. Enter the three- or four-letter airport code for that airport, or the airport name. When it comes up, scroll down to the "Airport distance calculator" on the right and enter the airport code for an airport by you – five miles or less is ideal. (If you don't have an airport by you, we will get to that in a minute.) Then click on the orange "Calculate Distance" button.

Airport distance calculator

From **KG00**-Nevada County Air Park
To **KOAK**-Metropolitan Oakland
International Airport

106.8 nautical miles SSW
Initial true course: 213

Typical distance calculator result. Many people do not readily relate to nautical miles (nm), so multiply nm by 1.15, or in this example, 106.8 x 1.15 = 123 statute miles. Also note that the compass direction of 213 degrees is based on True North at this site.

If you do not live near an airport or want a more advanced search, go to the AirNav.com link above and click on "Advanced Search." In Step 1, enter your latitude and longitude derived from a GPS receiver, a Topo map, or aero chart as close as you can. In Step 2, check only "Airports" and "Public" for starters. If you want to limit the search to larger airports, select "Precision only" under "Instrument approaches" and select "Jet A" under "Fuel types." In Step 3, with the search configured as above, select "Between 0 and 200" and also select "statute miles."

When the search results come up, the "WHERE" column data will be formatted like "68.6 mi ENE" for each airport. The "ENE" is one of sixteen compass points – East North East. The blue airplane icon at the left of each line will take you to info about the particular airport.

❖ VOR Radials

VOR stations are aids to navigation, and

one of a number of different types of NAVAIDs. Think of VOR stations as transmitting spokes like a bicycle wheel on its side – one spoke per degree. In simple terms, a pilot can fly to a point over a VOR station and then select which spoke, or more properly, which "radial" to depart from the VOR on.

A VOR 90 degree radial (090° - three digits are typically used), is 90 degrees clockwise from North – which makes it East. A cockpit readout shows the radials by number.

Published Intersections on aero charts are often defined by the location where a specific radial from one VOR intersects a specific radial from another VOR. In three-dimensional terms, the intersection can be thought of as a vertical line from the ground up. Passing through the intersection means passing through the vertical line at one altitude or another.

Published numbered Airways (highways in the sky) are formed in many instances by hopping among VORs and Intersections along VOR radials.

The compass roses for VORs are oriented to Magnetic North, but to add a little confusion, the Lat / Long lines on aero charts are oriented to

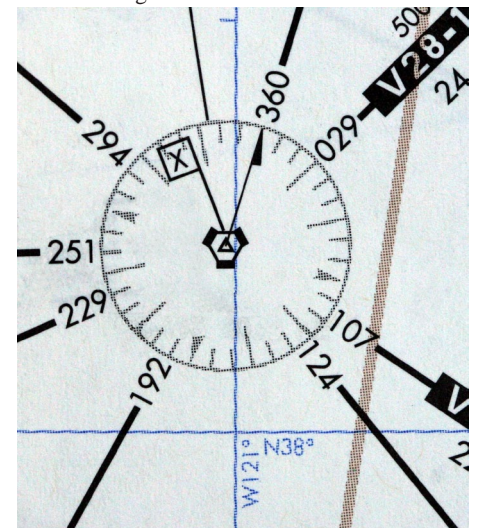

This is the LINDEN VOR, South and East of Sacramento International Airport (SMF) in Northern California. The flag with the "X" means that there is a minimum crossing altitude restriction over the VOR. On the compass rose, you can see numbered radials associated with published Airways. The W121° longitude line almost goes through the center of the VOR compass rose. Note that the VOR arrow points to 360° / Magnetic North and is offset angularly from the True North chart longitude line.

True North. You will hear Air Traffic Controllers frequently refer to VOR radials.

The VOR radial pointing North is referred to as the “three six zero degree radial” as opposed to the “zero degree radial.”

❖ Clock Position and Distance

Most of us have seen movies with air combat scenes where one crew member will call out something like “Three MiGs, two o’clock low.” This, as many of you know, is based on using a clock face for calling out relative directions.

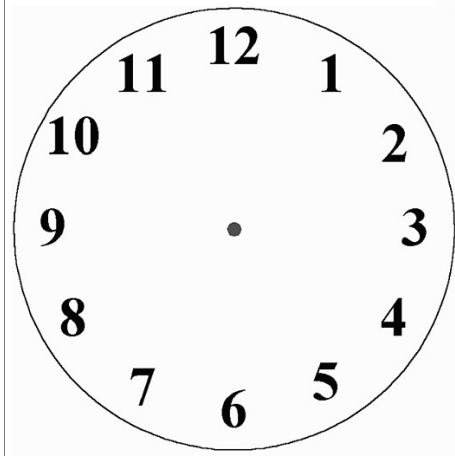

Imagine a large clock face on the ground and you are standing in the middle of it with twelve o’clock being straight ahead. Each hour then points to a relative direction. Controllers use the Clock Position and Distance method all the time.

Here are some examples of Clock Position and Distance:

Controller: *Alaska Three Sixty-Eight, descend and maintain three thousand, Sacramento International Airport twelve o’clock and one six miles.*

Controller: *[Call sign] Traffic eight o’clock, seven miles, southwestbound, descending out of one four thousand for eight thousand is a Southwest Boeing Seven Thirty-Seven.*

Controller: *SkyWest Fifty-Five Forty-Three, Roger, Traffic at one o’clock and nine miles, opposite direction, five thousand two hundred, descending. Also, a Southwest at your two o’clock at about one two miles, right to left, out of four thousand, descending.*

❖ Runway Numbering

Controller: *Cleared to land Runway Two Seven.*

No, no, airports don’t have twenty seven or more runways. The runway number is derived from its direction on the ground referenced to Magnetic North. Add a zero to runway numbers and you have degrees. Thus, Runway Two Seven is 270 degrees clockwise from North – which means landing or taking off directly to the West. The very same stretch of pavement in the opposite direction is Runway Zero Nine, or 90 degrees clockwise from North – landing or taking off directly to the East.

❖ Routes

An Instrument Flight Rules (IFR) route is a series of waypoints and bearings. Waypoints are most often VOR stations and Intersections.

Airlines often, but not always, begin their flights using a published and named Departure Procedure. For an example, enter SMF in the search box at www.airnav.com/airports/. Scroll way down to “FROGO SIX” under “Departure Procedures” and click on the link to bring up the PDF.

The parallel runways at Sacramento International are at the left near the top – vertically between “1500” and “600.” Whether an airliner takes off one way or the other from one of the runways, it will join the SACRAMENTO VOR 090° radial (R-090), pass through the THORN Intersection – defined by its intersecting with the MANTECA VOR 353° radial (R-353). It then proceeds to the FROGO Intersection and then to the FRIANT VOR.

Once airborne, a controller may alter the route by “vectoring” the plane (giving direction and altitude instructions) as needed to fit in with other air traffic. Looking at this departure “plate” can serve to help you imagine a cross country route with numerous waypoints.

Numbered Airways and Jet Routes are also part of route definitions. “Victor Airways” are shown on Low Altitude IFR charts (Ex: V-310). “Jet Routes” are shown on High Altitude IFR charts (Ex: J-93).

To see more of this sort of thing, when at an airport page using AirNav.com, scroll down and click on the “Sectional Chart” and a nice portion of a Sectional chart will come up. Once it does, and for this explanation, click on the “IFR Low” button at the top right of the sectional chart. Zoom in as needed. Click / grab and drag the chart as desired to reposition. This picture is worth a thousand words. You will see VORs, Victor Airways (also called “VOR Federal Airways”), Intersections, and a great deal more. Do the same thing by clicking on the “IFR High” button.

For the enthusiast who wants to dig into the all the symbols, go to http://aeronav.faa.gov/index.asp?xml=aeronav/applications/digital/aero_guide. You will see different downloads offered. Take a look at the “IFR Chart Symbols (3.0 MB).”

FlightAware.com shows route string data. After you have selected an airline flight at <http://flightaware.com/live/> look to the right of “Route” (white on blue in the upper right page quadrant) and you will see a string like: SFO8 SFO LIN JSICA MLF J80 FQF J44 MCK J130 PWE IRK SPI J80 VHP APE AIR J162 MGW ESL SHNON2 – in this case, for a specific flight from KSFO to KAID. Right after the string, click on the “Decode” link and it will show more detail, but it will not show Jet Routes (like J80, J44, J130, etc.) but mostly VORs, Intersections, and Waypoints – the same route nonetheless.

The 3-letter VORs may be looked up here www.airnav.com/nav aids/. The five-letter Intersections and Waypoints may be looked up here www.airnav.com/airspace/fix/.

The Jet Routes may be found here: www.faa.gov/documentLibrary/media/Order/7400.9.pdf, a 4 MB PDF. To search for J80, for example (using the PDF search box), use

the hyphenated form “J-80.” What you find will look similar to a planned automobile trip across the country. Try it! The same document lists the VOR Federal Airways – plus a ton of other stuff for those so inclined.

❖ Wind

Air Traffic Controllers at airport Control Towers can give wind updates to landing aircraft but, on average, such information is by way of automated (AWOS and ASOS) or repeating, prerecorded broadcasts (ATIS).

At AirNav.com, go to airports in your listening radius and look for ATIS, AWOS, and ASOS frequencies and take a listen. Wind, just one component of the broadcasts, is usually reported this way: *Wind – one four zero at six.* The “one four zero” is the direction in degrees from which the wind is coming. The “at six” is the speed in knots (times 1.15 for mph). Wind speed is rounded to the nearest ten degrees and referenced to Magnetic North.

Wind speed and direction can be more cryptic when a transoceanic airliner gives a scheduled report at a waypoint along a route on an HF ARINC frequency. Along with the various elements in the report, if you hear something like *one three five diagonal four eight*, that is the wind direction (Magnetic) and its speed in knots – as if the plane had stopped to take the reading. [For Pacific and Atlantic ARINC frequencies, go to www.arinc.com/products/voice_data_comm/air_ground_radio_svc/jepc_charts.html and download ARINC-3 and/or ARINC-4.]

Have fun. See you next time.



- ✓ Sale price
- ✓ Free Go Bag
- ✓ Free UPS shipping
- ✓ Free Race Scanning book

This is our **best deal** ever on a portable wideband receiver! The stylish Icom IC-RX7-05 receiver tunes from 150 kHz to 1300 MHz (less cellular and gaps), has 1650 memories, CTCSS/DTSC, backlit LCD, RF gain, attenuator and keypad. With Li-Ion battery, BC-149A charger and belt clip. List \$364.00 Regular price \$299.95 **SALE \$199.95**

Universal Radio
6830 Americana Pkwy.
Reynoldsburg, OH 43068
♦ Orders: 800 431-3939
♦ Info: 614 866-4267
www.universal-radio.com



Radio Doomsday? The end of the world online – Mayan style

In what surprisingly has not been a widely reported story (note the sarcasm), there are some who believe that 2012 is going to bring about the end of the world, thanks to ancient Mayan calendar makers who stopped looking ahead on their calendars after December of this year.

My theory has been they probably just ran out of room on their calendars, but there are those who are determined that this indicates the Mayan had some inside knowledge that the world would actually be ending at the end of this year.

Whether you buy into the doomsday hype or not, tuning in to some of the radio stations from the epicenter of the action could be at least an entertaining experience.

More than a primitive Nostradamus, the Mayans were a vast culture with an extremely advanced civilization. If nothing else, taking a glimpse into their culture can be not only informative but also enlightening.

❖ Where to look

The first thing you probably need to know when trying to find stations with a Mayan influence is where to look. The Mayan culture encompassed an area in the Mexican states of Chiapas, Tabasco, Quintana Roo, Campeche and Yucatan. It also extended into Guatemala, Belize, the northern extent of El Salvador, and Western portions of Honduras.

Some of the major cities to search for stations are Villa Hermosa in the Mexican state of Tabasco, Chiapas' Tuxtla Gutierrez, Tenabo in Campeche and Merida in Yucatan. The Yucatan and Quintana Roo states contain a large portion of the Mayan ruins that are commonly toured. As such, they are excellent places to start your search for Mayan radio.

It is a problem to find reliable station streams from this region. Many of the station streams are notoriously unreliable. They typically are unavailable for extended periods of time; plus, a large portion of the stations from this region are not yet found on the Internet.

I have found a quick search using a streaming service such as TuneIn or Reciva can produce pretty effective results. You may also want to try a general Web search, but this is only going to be effective if you are fluent in Spanish (or have a really good Web translator).

However, let's assume you find some station streams; what can you expect to hear?

❖ Beautiful music abounds

Since my childhood, the Incan and Mayan civilizations have fascinated me. Something about how these people were able to raise vast cities and structures from the depths of the jungle captures my imagination and inspiration – not to mention how they were able to possess a knowledge of technology and astronomy that escaped the rest of mankind until centuries later.

Like the Inca, the music of the Mayan people is deeply entrenched in the history of its people. While the centerpiece of Incan music is the panflute, in Mayan culture it is the marimba.

If you are looking for marimba music to get in a Mayan mood, Guatemala City's Marimbas del Recuerdo is a fantastic choice. There is modern flavored music to be found here, but much of it with the traditional marimba at the centerpiece.

I wish there was more to direct you to in your search for Mayan radio, but the lack of reliability of stations and the diverse assortment of stations means it really is going to be a matter of doing some searching using the links available to you in the links table below.

Fluency in Spanish is very helpful in listening to much of what you will find. There is a chance you will run across the Mayan dialect as well. Who knows? You may be lucky enough to catch some doomsday-themed programming straight from the source of it all!

The first step is knowing where to look and knowing what to look for. The rest is up to you and your preferences!

❖ Praising the 'Antenna'

I have a new favorite application on my laptop to listen to Internet radio. (Yes, I still use my PC and iMac from time to time.) It's called *Antenna* and it is an Adobe AIR application.

What makes it my favorite application? Web sites like TuneIn and the associated apps for mobile use make it easy to browse through stations by location, but the *Antenna* application is the easiest method I have ever found for finding station streams by location.

Antenna uses a map to zoom in on a specific location. You can choose from several map options, but the default is Yahoo! Maps. From there, you can click on an icon for a city where a station is located. This brings up a menu of stations from that city to choose from. You can also search for stations by station name or call letters, or sort through menus of countries, genres and more.

I have often wondered why the map feature hasn't been used in any Internet radio apps so far. It really does make it very handy when you want to listen to radio stations from a certain area. Let's say, for instance, you want to listen to stations from the southern coast of Australia, or from a certain hotspot during a breaking news event. With *Antenna*, you can



easily see what stations are available from that specific area.

During my testing, I was in a mood to hear stations from the northern African coast. Normally, I would look these up by country or specific city names. With *Antenna*, all I had to do was zoom in on northern Africa, and within seconds I was listening to music from a Moroccan station.

When I was doing research for the Mayan portion of the column, *Antenna* was extremely helpful. I was able to zoom in on the area where the Mayan civilization existed, which brought up several cities with stations streaming.

One thing I noticed was that there is no way to 'favorite' a station, as you can on many other streaming resources. I was able to overcome this by 'rating' a station. When listening to a stream, there are five stars which allow you to 'rate' a station. There is a menu option to view all stations you have rated, which would essentially do the same thing as making a station a 'favorite.' Using this technique, it probably isn't a good idea to rate a station that you wouldn't listen to again.

The only downside I have found thus far in my testing of the app is that there are a lot of stations missing – and there are some pretty glaring holes in coverage. For example, no Dallas, TX radio stations are shown on the map. I did a search for 'Dallas' and three stations popped up, but trying to connect to them resulted in a 'connection error,' so there are broken links.

However, I wouldn't let this dissuade you. There is still plenty here to enjoy, especially when looking from an international viewpoint. In addition, if you have a stream you would like to add, you can do so by clicking on the settings icon (it looks like a gear) and entering it in the dialog box at the bottom of the screen.

I have noticed that stations seem to pop-up and disappear at times, based, I am presuming, upon stream availability. For example, one of the stations in Villa Hermosa I had been listening to earlier in the evening during my research for the Mayan part of the column was no longer on the map a couple of hours later.

Another useful feature is a 'reliability' meter. Stations that show up as green are more reliable than those that show up as red. Obviously, 'red' doesn't necessarily mean 'dead,' and I have also found 'green' stations that were curiously silent. But, all-in-all, it is a handy tool when looking for stations.

My only technical complaint with this application is in an annoying thing that happens when you click on a stream to connect to it. Let's say I am zoomed in on the map to the city of San Salvador in El Salvador, and I want to check out a couple of different streams. As soon as I click on the stream I want to hear, it zooms back out to almost the full zoom out on the map.

If I want to go back and tune in another station from the same city, I will still have the menu of stations to choose from, but if I want to check the stations from a neighboring city, I have to zoom back in. When I am region surfing, this is only moderately inconvenient. It's nothing that should prevent anyone from

downloading this app, but it's something I hope they will rectify in future updates.

The application is free, and is available for both the Windows and Mac OS platforms as well as a Linux version. Find the link in GlobalNet Links below to download, as well as another link to a review of the application.

❖ GlobalNet Mailbag

This month's mailbag entry is in response to my recent review of Apple TV as not only an Internet radio device, but a general streaming resource for your home entertainment system. One reader offered up a worthy challenger to Apple TV.

Dear Loyd -

I am reading your GlobalNet since you have started on Monitoring Times. I am listening to Internet Radios since 2008, and really enjoy it. But I would like bring to your attention about Roku service. www.roku.com which bring TV and radios from around the world. I am watching BBC News TV, Aljazeera, France 24 and a lot more. Also you can listen to the Tunein radios.

Contrary to Apple TV about 95 percent of Roku apps are free. You can buy Roku boxes from its site or from Wal-Mart stores about \$78.00. You first register your unit online, then you can use it. Roku needs a valid credit/debit card on file if you decide to buy some paid apps.

73 - Piran Mohazzabi, AB8HU

Piran, thank you for your email! Indeed, I have heard some really great things about the Roku boxes, although I haven't had a chance to test them out myself yet. A friend of mine recently purchased a Roku box after much debate between a Roku and an Apple TV device. I let him test Apple TV through my system and he says he likes the interface and apps that are available on the Roku device more than what he saw with Apple TV. I think it comes down to a matter of preference and what you are trying to do.

I have thought about setting up a Roku box in my bedroom, as I have more options for connecting a Roku box to my older television for streaming services such as Netflix and Hulu Plus. With Apple TV, my only option is HDMI.



The only thing I do really like about Apple TV that I would miss with Roku is the native and built-in support for AirPlay streaming from other AirPlay enabled devices.

If any other readers have had a chance to experiment with the Roku box, I would love to hear about your experiences. There are other options out there as well, including built-in apps within flat-screen televisions. Sometimes it is hard to keep up with the new developments that are constantly hitting the streets, but I will do my best to keep you all on the cutting edge of streaming!

GlobalNet Links

- Antenna Download - www.downloadcrew.com/article/26246-antenna
- Antenna Review - <http://betanews.com/2011/12/02/antenna-turns-your-pc-into-an-internet-radio/>
- TuneIn Search Results for Yucatan - <http://tunein.com/search/?query=yucatan>
- TuneIn Search Results for Campeche - <http://tunein.com/search/?query=campeche>
- TuneIn Search Results for Tabasco - <http://tunein.com/search/?query=tabasco>
- TuneIn Search Results for Quintana Roo - <http://tunein.com/search/?query=quintana+roo>
- TuneIn Search Results for Chiapas - <http://tunein.com/search/?query=chiapas>
- TuneIn Search Results for Guatemala - <http://tunein.com/search/?query=guatemala>
- TuneIn Search Results for Belize - <http://tunein.com/search/?query=belize>
- TuneIn Search Results for El Salvador - <http://tunein.com/search/?query=el+salvador>
- TuneIn Search Results for Honduras - <http://tunein.com/search/?query=honduras>

Sangean WiFi Radios

Now you can enjoy the excitement of accessing over 16000 Internet Radio Stations almost anywhere when you own a new Sangean Internet Radio and in addition enjoy any of your local standard FM broadcasts using the built in FM tuner with RDS (RCV56) or upload your favorite or any internet station to your Sangean's "My Station" allowing quick and easy future access. You no longer need to be glued to your computer to access your favorite Internet station nor do you even have to have your computer on. All you need is a broadband internet connection and a wired or wireless router. Add to your listening pleasure by creating your own Digital Music Library. Sangean WiFi radios offer the ultimate in Internet Radio listening.

Order RCV56
\$279^{95*}
* plus \$13.95 UPS Ground shipping in the U.S.

800-438-8155
828-837-9200 fax: 828-837-2216

www.grove-ent.com



RDF-304 Wrap-Up

Last month we took a break from the Aqua-Guide RDF-304 project to ring in the New Year. We presented a list of signals and services you could hear on longwave from Natural Radio at the low end, right on up to marine bulletins at 518 kHz. There is a lot happening in this part of the spectrum, and I hope you were prompted to make longwave a part of your listening plan for 2012. Soon, I hope to report on a new ham allocation here, pending the results of the World Radiocommunication Conference (WRC-12), currently underway in Geneva, Switzerland, and concluding on February 17th.

This month we return to the RDF-304 direction finding receiver. In case you're just joining us, we undertook the evaluation, repair, and try-out of this receiver which I purchased used at a hamfest several years ago. The primary trouble was low and distorted audio, which was fixed by replacing defective capacitors on the circuit board. I have since replaced more capacitors as a proactive measure against future failures of these age-vulnerable parts.

This month, we'll cover some basic cosmetic restoration steps and then put the radio back into full service. For the past articles on this set, refer to the November and December 2011 editions of *Below 500 kHz*. Reprints are available from the editorial offices of *MT*.

❖ Great (Yet Reasonable) Expectations

Well, with the receiver now playing, it's time to put the finishing touches on and get it back into service. There are several different levels of cosmetic restoration, ranging from merely improving the current appearance of a set to returning it to true showroom quality.

My work on this unit will stop short of the latter category. For one thing, repainting the wrinkle finish on the top and bottom covers is beyond the scope of my current abilities, so that step is off the table – at least for now – pending some serious practice with scrap materials, and finding the right paint and paint color!

I may never repaint the covers, but I will say that they are not too bad the way they are. I can certainly live with a few chips and a faded finish. In a way, it adds to the "personality" of this rugged set, which probably saw many years of service on the open waters. Some things are best left the way they are, at least until they can be restored properly. We will, however, give the set a good cleaning, polish the dull plastic pieces, and spruce things up so that it looks decent sit-

ting on the bench and is more enjoyable to use for listening.

❖ Cleaning the Controls

Our primary work so far has involved operational repairs. Before moving on to cosmetic issues, I will apply a shot of control cleaner/lubricant to all of the front panel controls and switches. Hands down, the best brand of control cleaner/lubricant I have found is Caig De-Oxit D5 (www.caig.com). It's not cheap, but it works well, and has a lasting effect on controls with its included lubricant. The small can I purchased has a "High-Medium-Low" setting on the spray nozzle, and I generally leave it set at the lowest level. Not only does this make the product last longer, but it helps avoid over-spray onto other components that you're not targeting.

Next, I will place a drop or two of oil on the pulley shafts of the tuning string path and other moving parts on this route, working them in by rotating the tuning knob back and forth. *Be very careful not to get oil on the tuning string itself, or slippage may result!*

❖ Slippage Remedies

I didn't have any trouble with a loose tuning string on my set, but if you do encounter this trouble, you can generally tighten it by tying an extra knot or two at the end point to shorten its length slightly. Another trick, especially useful when slippage occurs around the tuning knob shaft, is to apply a little bit of rosin to the string to increase friction. This is the same stuff that musicians use for stringed instruments, and it can be found at most music stores. A small amount ground into a powder and applied to the string usually works wonders to cure axle slippage. I bought a small box of this stuff years ago, and it should last me a lifetime.

❖ Antenna & Control Knobs

I have noticed that the telescoping "sense" antenna of this set works rather stiffly, a common problem with old sets. I cured this problem by spraying a liberal amount of WD-40 on a rag, and then wiping it over the extended antenna. I then worked the antenna up and down a few times, and it slides very easily now. Problem solved. (As a side note, I've also been working on a vintage Lafayette HA-135 Walkie-Talkie with this same issue, and the cure worked there, too.)

My next step is to clean the front panel knobs of the receiver. They are secured with small hex screws, so these must be loosened to slip them off

their shafts. I first placed them in a small bucket of warm, soapy water, letting them soak in it for a while. Next, using an old toothbrush, I cleaned out the flutes on each knob and rinsed them with clear water. After letting them dry, I re-installed them on each shaft of the radio. Now, instead of a milky white appearance, they are solid black.



Cleaning the knobs made a real difference in the appearance of the set. A bucket of warm, soapy water and an old toothbrush made the job easy.

❖ Final Polish & Wrap-Up

The rotatable antenna housing on the top of the set is made of black plastic. While it's not in terrible shape, I know it can be greatly improved by polishing it with another favorite product of mine, Novus Plastic Polish #2 (www.novuspolish.com). This stuff removes small scratches and restores the glossy shine to just about any plastic it's applied to. You simply apply a light coating with circular rubbing motion, and when it's dry, buff the area with a clean cloth. I follow this up with Novus Plastic Polish #1 which restores the luster to the finish.

This completes the work on our project set. It's working fine now, and can serve a real purpose in DFing or turning a deaf ear to interference. The only thing I might want to do in the future is add a DC power cord that could be used in place of the battery pack inside the set. I'll typically be using it indoors, and not very frequently, so it makes sense to run it on external power, rather than have batteries sitting in it for a long time. A power cord could be easily made with some red (+) and black (-) wire and an inline fuse. The fuse is important for circuit protection. A 1.0 ampere fuse should be sufficient for basic protection against short circuits.

Thanks for joining us through this rehab project of a longwave set. I'm spying another DF set for a future project, but this one is a much

smaller, lighter radio that can even be used while walking. Please let me know if you like these kinds of articles, and I will plan accordingly for the future.

Oh, by the way, while re-assembling the RDF-304 I found a small marking on the cover in grease pencil, indicating the price I paid for it. The amount? Five dollars. Not a bad investment for a fully functional 3-band receiver with a directional antenna!



The completed RDF-304 project. The radio should now provide years of service on its Longwave and two mediumwave bands.

❖ Mailbag

Mario Filippi, N2HUN (NJ), was one of several readers motivated by our series on the RDF-304 receiver. He writes:

Your recent article on RDFs jump-started my interest in these radios, and I can vaguely remember seeing ads about them in the 1960s. I have been a longwave enthusiast since the 1980s when I discovered the beacon band. Many loggings over the years have been accomplished, first with a Kenwood R-2000 then with a FRG-7 outfitted with a Palomar longwave converter. My favorite beacons were the ones that transmitted voice weather reports and I often imagined them somewhere out in the ocean doing their duty 24/7.

When a large portion of marine beacons were decommissioned in the 285-325 kHz region my interest waned, but the remaining aeronautical beacons at least kept me listening, albeit sporadically. At some point the Palomar and R-2000 were sold and I had no access to the beacon band.

But, the RDF radio article of yours caused me to shop around, because even though the beacon band may be on borrowed time, these receivers have other bands of interest to the hobbyist. I've done a lot of data mining on the Internet regarding these radios and there were many produced by several different companies, including Heathkit.

Well, I looked around to purchase one and found one at the online auction site; it was a Ray Jefferson 630 and includes AM, FM, CB, VHF Marine, and the LW band. As per the seller who has a 100% feedback rating, it's new old stock from the '70s! I am awaiting its arrival and will evaluate it, maybe take some pictures and send them along to you. I guess the CB band was added to this particular model since it was becoming popular at that time.

I hope to use this radio mainly for listening to aero beacons and MW DXing and dabbling once in a while on CB and VHF listening. Well, thanks for a great column on the basement band, and I hope you get the Aqua-Guide working. (Mario has since received his set, done some DXing, I plan to present an update in a future column. -K.C.)

We were also pleased to hear from **Irv Sanders, K3IUJ (PA)**, who writes:

The November issue of *MT* finally arrived today, and while I was doing a fast pass through the pages, 50's to the end, as I always do before I settle down to read the entire magazine. I spied the Aqua-Guide and had to read

the entire article. I have only seen one of those before and that was when I received one for repair and restoration years ago.

As I remember, it too had distorted audio and the "fix" was quite simple. Back when those sets were manufactured, low voltage electrolytic capacitors were not manufactured as they are today, and they either changed capacitance or became leaky or shorted or both, especially if they were stored in a damp basement and hadn't been played for several years. Since that set uses electrolytic capacitors for bypass, coupling, and filtering, you could spend quite a few hours trying to find the defective one(s). Those capacitors are now very cheap and replacing all of them is faster and less nerve provoking.

Having had 50+ years designing, repairing and restoring all kinds of electronics, I thought I would pass along a little of what I've learned over the years. P.S. I still prefer restoring "tube" gear. Real Radios Glow in the Dark!

In the Lost & Found category, **Al Bauernschmidt, N3KPJ (PA)**, writes: Hello, Kevin - I'm writing to ask your help in IDing a beacon. For the past week or so I have been hearing a station here in Allentown, PA but cannot seem to be able to find any info on it through my usual sources. The ID that I am hearing is CEM and the frequency is 254.75 kHz. I'm hearing it early in the mornings as well as after local sunset at which time it is the strongest. Any help that you can provide would be greatly appreciated. Also, your column in *MT* is great and I look forward to it every month. Take care & thanks for your help.

Hello Al, and great to hear from you. I think I have an answer to your mystery station, thanks to some quick research on the NDBRNA website (www.classaxe.com/dx/ndb/rna). 254/CAT in Chatham, NJ has been reported to be miskeying as CEM, so I suspect this is what you are hearing. Reports indicate that it has been in this condition since at least September, so it appears this is not a top priority for the beacon operator! Listeners in 14 states have reported hearing the station as of this writing. Many thanks for your report, and glad to hear that you are enjoying the column. Please keep us posted on CEM/CAT.

That's it for this month. 73, and best LW DX!

NOW AVAILABLE

Radio hobbyists interested in receiving and identifying radio stations in the HF/VHF/UHF radio spectrums now have a new whopping 1414 page CD-ROM publication to aid them.

International Callsign Handbook is a concise world directory of various types of radio station identifications covering the military, government, maritime, aeronautical, and fixed radio stations on CD-ROM. Thousands of callsigns and other types of identifiers have been collected from our own personal log book, official sources and dedicated hobbyists who contributed their material.

World QSL Book - Radio hobbyists interested in receiving verifications from radio station now have a new CD-ROM publication to aid them in the art of QSLing. This 528-page eBook covers every aspect of collecting QSL cards and other acknowledgments from stations heard in the HF spectrum.

"I'm impressed. This is a comprehensive collection of worldwide radio identifiers likely (and even some less likely) to be heard on the air. Over the years the Van Horns have earned the well-deserved respect of the monitoring community. Accurately assembling a collection like this is a mammoth undertaking. Congratulations on a job well done."
Bob Grove - December 2008 What's New Column, Monitoring Times magazine

Both books may be ordered directly from Teak Publishing via email at teakpub@brmemc.net or via our two main dealers, Grove Enterprises, www.grove-ent.com, and Universal Radio, www.universal-radio.com.

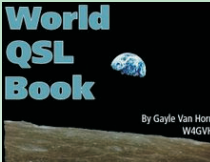

TEAK
Publishing
PO Box 297
Brasstown, NC 28902
teakpub@brmemc.net

From Teak Publishing either book is \$19.95 plus \$3.00 (US) and \$5.00 (Int'l) first class mail. Paypal, Cash, Check or Money Order accepted. NC residents add state sales tax.
Dealer inquiries/orders welcomed.



RADIO RESTORATIONS

BRINGING OLD RADIOS BACK TO LIFE

Marc Ellis, N9EWJ

marcellis@monitoringtimes.com

Aligning the Meissner “Broadcast 7”

Last month, because of a tight deadline schedule coupled with the fact that I needed to get ready for a long trip, we digressed from the Meissner project. I needed a topic that would not require as much preparation, and so I substituted a column on World War II radio reproducing devices. I hope that you found it as interesting as I did! Now I'm ready to get back on track with the Meissner project, but first let's review what has gone before.

When I first acquired this set, I thought it was probably a two-band receiver because the set's slide-rule dial carried calibrations for both the broadcast band and a 6-18 MHz shortwave band. However, there was no bandswitch, and checking the Meissner numbers against vintage catalogues revealed that the coils were all for the broadcast band.

But there was an oddity about the coils. All three: the antenna, r.f. and oscillator coils, were Meissner universal replacements. As such, each was provided with an adjustment to tweak its inductance to match that needed for proper tracking in the set being repaired.

First of all, the use of Meissner universal replacements in a Meissner radio made no sense. Even in the unlikely event of all three original coils having burned out, it would have been a lot simpler to replace them with the correct Meissner fixed coils than with the universal replacement ones.

Checking the set, part for part, against the Meissner pictorial diagram, I found it otherwise virtually identical to the Meissner “Broadcast 7” broadcast-only receiver. The only important difference was that my “Mystery Set” had significantly better power supply filtering.

I was beginning to think that the radio was perhaps a factory prototype for some variation of the “Broadcast 7.” Additional evidence for this is that the set was definitely factory wired while, as far as I know, Meissner sold the sets of this era only in kit form.

At this point I decided to fire up the radio after (1) replacing all the capacitors except for the triple 50 uF electrolytic in the power supply filter circuit and (2) clip-lead connecting an output transformer and permanent-magnet speaker along with a resistor-and-choke to take the place of the field coil that would have been present had my speaker been the preferred dynamic type.

After a reasonable warm-up, the set came to life and I heard a couple of Spanish language programs. But I didn't have time to investigate further in that work session, which was the last one with the Meissner until now.

❖ Smoke Test Part 2

I started the current session with the knowledge that the radio was working, at least a little bit, but I hadn't had a chance to verify reception across the whole tuning range. This was important because the set had been fitted with those adjustable universal antenna, r.f.

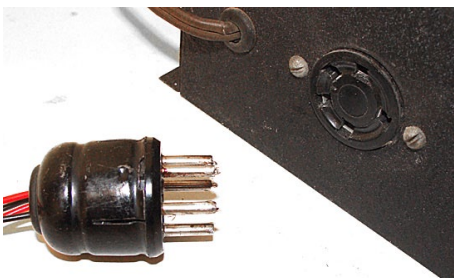

Before starting this month's session, I made up a speaker plug to fit the socket at the back of the set.

and oscillator coils – which is one of the things that made me wonder if the set might not be an experimental prototype, perhaps covering an unusual tuning range.

But before putting the radio through its paces again, I wanted to get rid of the rat's nest of clip leads by which I had hooked up the speaker, choke and resistor. They represented a short circuit just waiting to happen. Luckily I had an Amphenol 5-pin plug that matched the speaker socket on the rear chassis apron. After wiring it up, I turned the radio on again, hooked up several feet of wire as an antenna and awaited results.

Soon I was receiving signals across the entire broadcast band and, from the station announcements I heard, it was obvious that the set was in fairly decent calibration. I was no longer in any doubt that this radio – despite the unusual coils – was definitely intended to be a standard broadcast receiver.

Why the odd coils and the obvious factory wiring job on what should have been a kit receiver? Not to mention the two-band dial and the enhanced filtering circuit? Looks like we'll never know. Perhaps this was indeed some sort of prototype or test radio. Or perhaps it was simply a set that a Meissner employee had put together using parts scrounged from the factory.

❖ Realignment

At any rate, now that I knew that the set was indeed intended to tune the standard broadcast band, I felt free to proceed with a realignment. The procedure for this radio, as outlined in the Meissner manual, is quite standard. The output of the service oscillator, set for 456 kHz, is first connected to the grid of the oscillator/mixer tube through a small capacitor.

An output indicator such as a VTVM set at an a.c. range is connected to the audio output stage. It could be connected across the speaker voice coil leads, but I prefer to hook it up between the plate of the audio output tube and ground – with a capacitor of about .01 uF in series to keep the d.c. out of the meter. That connection provides a much more sensitive indication.

Since this radio has a tuning eye, its indication could very well have been used as an output indicator and I'm sorry I didn't try it. But the mechanics are such that the cabinet can't be installed with the tuning eye mounted on the front panel. It has to be installed after the cabinet is in place. So I disconnected it and put it aside early in the restoration to protect it from damage.

THE AWA GATEWAY

Have I introduced my *MT* readers to *The AWA Gateway* yet? I don't think so, and I'm not sure why. Perhaps it's because I do get so thoroughly immersed in the restoration issues to be covered in this column that I may not always step back to take a broader look at things.

At any rate, the *Gateway* is a free quarterly publication downloadable from the Antique Wireless Association website at www.antiquewireless.org. It was introduced last March as a sister publication to *The AWA Journal*, which is the quarterly bulletin of The Antique Wireless Association. I'm the Editor of both publications, which are released in alternate quarters.

Unlike the case of the *Journal*, *Gateway* content is slanted towards those who have a strong interest in vintage radio history and restoration, but who may not yet have acquired a lot of background. It's a sort of “Antique Radio 101.” It also serves as an additional venue for communication of current news about AWA to AWA members.

I won't take up any more space in this column to discuss the *Gateway*, because it is available on line for you to browse any time. There are now four issues on the site, completing our first year of publication. Comments are welcome.

FROM THE READERS

Reader **Jim Falls**, who recently came across some of my *MT* articles on the BC-344 restoration, wrote to tell me about some of his troubleshooting adventures with a BC-312 receiver. The BC-312 (1500 - 1800 kHz) is a HF companion receiver to the LF BC-344 (150 - 1500 kHz). However, the '344 has an a.c. supply, while the '312 operates from a dynamotor. The a.c. and dynamotor power supplies are interchangeable within these receivers. When originally equipped with an a.c. supply, the BC-312 is known as the BC-342. When originally equipped with a dynamotor, the BC-344 is known as the BC-314.

Jim's problem was distorted and crackly audio in MVC mode. He traced it to a couple of leaky bypass caps located in a 3-section oil-filled capacitor. Cutting the leads to the defective units, he connected them to a couple of modern replacements, using the shield from a conveniently located cable as a ground.

With that problem taken care of, Jim treated his receiver to a complete r.f. and i.f. alignment and then stayed up until the wee hours listening to it with the latest *MT* SW Broadcast schedule by his side. Jim also enjoys using his '312 for SSB reception on the ham bands because its excellent no-backlash vernier is perfect for the critical tuning required in that application.

Reader **Ralph Stern**, and another whom I know only as **Victor**, both came up with paint questions. Victor was looking for a source of paint in the correct color to refinish the cabinet of his NC-183; Ralph was looking for a gray wrinkle paint for use in a restoration project.

I drew a blank on the gray wrinkle paint question. Though I did find one source, it was extremely expensive and was also advertised as being suitable only for touch-up of small areas. Perhaps one of our other readers can help – if so, please contact me and I'll spread the word.

While I don't know of a paint source for specific National cabinets, Ralph's problem might be solvable at a home center or auto body shop. Both are likely to have facilities for scanning and computer-matching colors – though I suppose that the home center might be more amenable to making the small quantity of paint that he would need.

Finally, Victor, responding to my description of the buzz-saw noise that was troubling me during my recent BC-1206-C project, comments that the noise sounds similar to that generated by his computer printer. And that noise is present even with the printer shut off. Definitely a fact worth knowing, though my particular noise was present even with the main breaker of our house turned off.

Have you priced eye tubes lately? Ouch!

The manual recommends the standard procedure of running the volume control full on during the alignment while keeping the output of the signal generator just high enough to get a good indication on the output meter. This ensures that the signal passing through the set will not be strong enough to engage the automatic volume control – which would then flatten the signal peaks that we try to maximize during alignment.

Now the four trimmers at the tops of the two i.f. cans were adjusted, one by one, for maximum indication on the output meter. As is usual for realignments of long-neglected radios, this process resulted in very significant gain increases – necessitating frequent reductions in generator output to keep the signal passing through the receiver at the necessary minimal

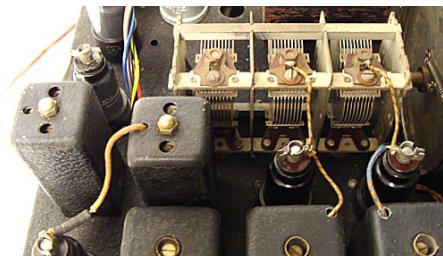

The main three-section tuning capacitor with its three trimmers is at the top of the picture. Just below it and to the left are the two i.f. transformer cans. At the bottom are the three "Universal Replacement" coils (see text).

level. As is also usual, and recommended in the manual, the peaking of the i.f. trimmers was repeated a couple of times to make sure of obtaining maximum gain in the i.f. channel.

The next step was to peak the tuned circuits in the front end of the receiver: at the antenna, r.f. amplifier and oscillator stages. The trimmers for these are located atop the three-section variable capacitor that tunes the stages – making possible the necessary small adjustments in the capacity of each section.

These adjustments are carried out at 1400 kHz. Both the radio dial and the signal generator are set to that frequency, and the output of the generator is connected across the antenna and ground terminals of the receiver through a 200 pF capacitor. This capacitor simulates the presence of the antenna that would be connected to the receiver during normal operation.

In the alignment of some high performance sets, where adjustment is much more critical, a standard "dummy antenna" is used instead of a simple capacitor. This is an easily put together network formed by a choke, a couple of capacitors and a resistor. I keep one at my bench, and have used it in a couple of alignments previously done on these pages.

As in the case of the i.f. alignment, this front-end alignment is done at minimum signal strength, with frequent reductions in generator output as the gain of the circuits is improved. As specified, the antenna, r.f. and oscillator stage trimmers, located respectively at the back, middle and front of the main tuning capacitor

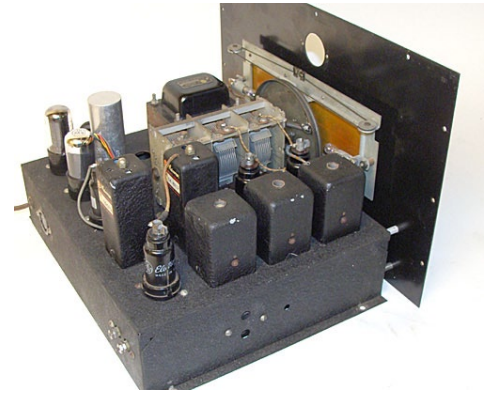

The "Broadcast 7" will be ready for re-installation in its cabinet once we take care of the sticking dial drive.

were peaked in that order.

The next step in the alignment is done to obtain reasonably accurate frequency calibration across the entire dial. It involves an extra adjustment of the oscillator stage (which determines where on the dial a station of a given frequency will appear) using a small adjustable capacitor called the "oscillator padder." While the general alignment was carried out at 1400 kHz, the padder adjustment was made at the other end of the dial – with the signal generator and receiver set at 600 kHz.

Finally, as specified, the alignment process was completed by repeating the 1400 kHz adjustments of the antenna, r.f. and oscillator stages. The adjustments on the "Universal Replacement" coils were not touched. With the radio connected to an outside antenna, I picked up a lively assortment of stations all across the dial. And I noticed that the set was unusually free of inter-station noise.

See you next time when we will take care of a few mechanical problems – including a binding tuning dial that I had thought to fix at the last minute with a few drops of WD-40. But, alas, it looks as if I might have to dismantle the entire tuning drive to find a solution.

Join the AWA

ANTIQUÉ WIRELESS ASSOCIATION

THE ORIGINAL AND LARGEST HISTORICAL RADIO-COLLECTOR GROUP

- Publishes *AWA Journal* with:
 - Battery and AC receiver restoration
 - Vacuum-tube history and collecting
 - Old-time amateur-radio contests
 - Communications receivers
 - Free want-sell-swap ads
 - Early television
 - Horn loudspeakers
 - Reviews of current books
 - Keys and land-line telegraphy
 - News of U.S. and foreign clubs
 - Information on public radio museums
- Maintains unique radio-TV museum.
- Produces the annual Rochester meet.
- Co-sponsors local meets.
- Publishes the annual *AWA Review*.

Membership is only \$25 per year U.S.A. (\$30 per year elsewhere). Write to:

AWA Membership Director
PO Box 421, Bloomfield, NY 14469-0421

www.antiquewireless.org





ANTENNA TOPICS

BUYING, BUILDING AND UNDERSTANDING ANTENNAS

Dan Farber, ACOLW
danfarber@monitoringtimes.com

Keep It on the Down Low Get on 160 and 80 Meters

Well, friends, here we are again in the dead of winter. It's cold, it's windy, it's snowy ... but it's the time of year when the low frequencies are at their best. Even with the sunspots returning, 160 and 80 meters can be quite rewarding in the wintertime. At night in the winter, a wonderland of DX possibilities open up to the operator who has a good antenna for these two lowest ham bands.

The hardest part about getting on the lower bands has traditionally been the brick wall presented by the laws of physics – full-size antennas here are HUGE. Whereas a 10 meter dipole is only a bit over 16 feet long and plenty high enough for low-angle DX at a mere 20 feet up in the air, an 80 meter dipole is 130 feet or so long, and for most of us impossible to raise 130 feet above ground, even if we had room for the span, which many of us don't.

160 meters is even more daunting: a dipole is 250 feet long, and, unless you can string it between two 25 story buildings a couple of city blocks apart, will not be much of a low-angle radiator. Yagis or quads at these

frequencies would be enormous, terrifying monstrosities that would weigh a ton and cost a fortune, even if they could be erected and rotated. To be realistic, we need to look beyond these traditional horizontal-type antennas and try something else.

The commonest answer, and the one that comes most readily to mind, is the vertical antenna. Let's talk about some of the possible permutations and pitfalls of this type of antenna for the low bands.

The big advantage of a vertical at these low frequencies is that we get away from the enormous *height above ground* requirement incumbent upon the above-mentioned horizontal antennas. Indeed, as we know, a vertical can be and often is literally ground-mounted. With an adequate ground system and sufficient radiating element length, the vertical is a great alternative to trying to put all that wire high in the air.

Of course, a full-length quarter wave vertical at 80 meters is around 65 feet long, and for 160 a much more daunting 130 feet, so most vertical installers will have to accept some sort of *loading* of a shorter length. A loaded vertical will be less efficient, and will have a narrower effective bandwidth, but for most operators it will certainly be an acceptable compromise. Loading comes in several flavors, mainly base loading, center loading, and top loading, which refers to what part of the vertical radiator the loading coil is located in. Center and top loaded versions are billed as being more efficient, but base loading makes the coil much more accessible for adjustments.

By the way, we've all seen how prevalent the 43 foot vertical has become on the commercial market. The idea is that 43 feet is a fortuitous compromise length that will load up on all bands, 160 through 10, using only an *unun* at its base and low-loss coax to feed it. What they don't tell you is that, on 160 and 80, the antenna is far too short to load up efficiently. If you want to try this 43 foot vertical as a solution for 160 and 80, you need to add a matching network, such as HyGain's



HyGain's AV-6110, a matching network that makes a 43 foot vertical actually WORK on 160 and 80 meters. (Photo courtesy MFJ Enterprises)

AV-6110, available from MFJ for about \$300. Phil Salas AD5X, shows on his web page, <http://ad5x.com>, how to build several varieties of a matching network yourself at a more reasonable cost of around \$65 to \$150.

The big disadvantage of a vertical, especially at low frequencies, is how noisy it is on receive. A lot of atmospheric and other electrical noise seems to be vertically polarized, making receive a more difficult (and stressful) task. Also, since a vertical works against a "ground image," an effective grounding system is absolutely essential if you hope to transmit effectively. Contrast this with the big dipole, which by virtue of being a "balanced" antenna, can work quite well with poor or nonexistent RF grounding.

This brings us to the compromise solution I use at my QTH. Regular readers of my column have seen me frequently

rant and carry on about my 102 foot dipole, up 35 feet and fed with ladder line and an MFJ 969 tuner. On every band 40 through 6 meters it is a tremendous DX performer, being sufficiently long and high in the air to give excellent low-angle radiation and even some gain on higher frequencies.

The icing on the cake, though, is how well it performs as a *vertical* on 160 and 80. To review, friends, this is accomplished by tying the two ladder line conductors together at the shack end and feeding them as a random wire. In this configuration, the feedline itself becomes a vertical radiator, and the two 51 foot dipole halves become a "capacitance hat" that helps greatly to load up the vertical on these lower frequencies.

I have about 45 feet of feedline between the tuner and the dipole, so in this configuration I basically have a 45 foot tall, top-loaded vertical, that performs very well on the low bands. Note that this is a fairly well-known trick, and that folks variously call the resulting antenna a "tee vertical" or a "marconi."

Two simple crutches greatly increase the ease of use (and the performance) of this setup. The first was a product of laziness – I

DX Engineering's DXE-MBVE-1, one of the popular 43 foot verticals on the market. (Photo courtesy DX Engineering)



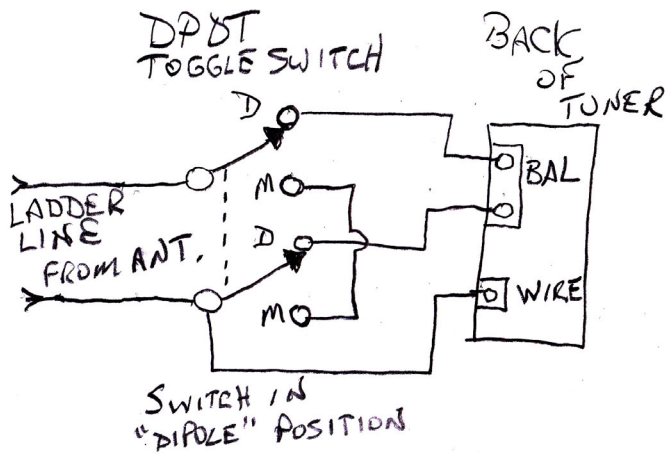

The author's clever switching arrangement enabling the ladder line-fed dipole to be used as a 'marconi'. (Drawing by author)

hated having to keep reconfiguring the ladder line connections to the tuner for "dipole" or "marconi." Eventually it dawned on me that I could connect a simple double-pole, double-throw toggle switch in such a way as to get either configuration at the flip of a switch.

The schematic shows the result: on "dipole," it's the normal connection with the ladder line fed from the BALANCED output of the tuner, with one side jumpered to WIRE; on "marconi," the two ladder line wires are tied to WIRE, with the balun now out of the circuit. Believe it or not, this gave me the unexpected benefit of being able to switch to "dipole" when receiving on the low bands to hear stations that were buried in the noise on

cal – ground rods, cold water pipe, a system or buried or surface radials, whatever you can rig up. But one simple wire will often give you amazing improvement, regardless: I speak, of course, of what is usually called a *radial counterpoise wire*. This is simply a length of insulated wire, cut to a quarter wavelength for the desired band, and laid out wherever you can lay it out.

You can connect a wire for every band desired, if you like. Just strip one end and connect it solidly to your rig's ground – ideally, the tuner ground. Make sure the far, unstripped end is taped, because it will carry a high RF potential. (It's considered poor taste to zap

the "marconi" setting. I switch back to "marconi" to transmit, and many QSOs have thus been possible for me that the vertical's noisy receive performance would have otherwise precluded. Someday I'll rig up a *non-manual* way to switch it....

The other trick is also well known, and I highly recommend it for improved performance of any vertical or random-wire arrangement. We all know that you need the best ground system you can come up with to use a vertical

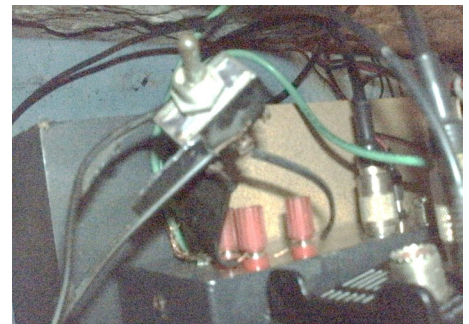

The switching setup behind the author's tuner, held neatly in midair by wire stiffness. (Photo by author)

the kids or the cats.) I have a 130 foot wire for 160 and a 65 foot wire for 80, laid out around the indoor perimeter of my basement. The improvement in loading, bandwidth, and performance is considerable. Keep this in mind for any random or oddball antennas you happen to try.

In a future column, we'll talk about some of the other ideas you can use to get on the low bands, including physically small and stealthy antennas. Loops of various configurations have become popular for accessing the low bands, and don't overlook that second or third floor gutter system as a total stealth antenna for 160 and 80. Just make sure it's metal gut-tering: plastic is a VERY poor conductor!

That's all for this month, friends. Join me here again in March, when we'll delve ever deeper into the world of HF antennas. Until then, happy operating!

Grundig S450DLX Field Radio

AM/FM/Shortwave Field Radio with Liquid Crystal Display

- AM/MW (520-1710 KHz / 522-1620 KHz), FM (88-108 MHz), SW (continuous frequency range from 1711-29999kHz)
 - Frequency Tuning Steps: 3 methods to choose from (fast/slow/stop)
 - Analog tuning with digital display
 - High performance IC and MOSFET: Provides high sensitivity, strong anti-interference, low background noise and lower distortion.
 - MW/SW IF wide/narrow bandwidth selection: improves audio fidelity and minimizes noise.
 - MCU Control (micro controller unit) and large LCD backlight display with: frequency, clock, battery level indicator, and signal strength indicator
 - AM band features dual conversion PLL technology: provides anti-image rejection.
 - 50 station memory (10 presets for each band)
 - Dual alarm with wakeup, snooze, and sleep functions
 - AM/FM/SW external antenna input socket and the ability to connect to cable FM.
 - Individual MW 500 Ext./GND socket for external antenna and ground to improve MW sensitivity
 - Strap type carrying handle
 - Full-range speaker with variable independent bass and treble control
 - Stereo line level audio input/output and Stereo/Mono selection
 - Power source: 6 x D batteries (not included) or DC IN (9V), negative polarity, 500 mA adapter
 - Includes: owner's manual, warranty card, AC adapter
- Dimensions: 12.2" x 7.6" x 3.9" (W x H x D) Weight: 3.59 lbs. (1.63 kg)



Order RCV70
only **\$99.95**
plus \$9.95 shipping and handling

GROVE

www.grove-ent.com
800-438-8155 828-837-9200

7540 Highway 64 West
Brasstown, NC 28902



Spotlight on VUSAT OSCAR 52 (VO-52)

In previous columns, I've been assisting those interested in receiving and (if properly licensed) actually working through our growing fleet of Amateur Radio satellites with just modest radio equipment. In this edition, I'll turn the spotlight on one of our newest (linear) analog satellites, and then bring you up-to-date on the latest happenings in this fascinating aspect of amateur radio.

VO-52 (also known as VUSAT and/or HAMSAT INDIA prior to launch) is yet another of AMSAT's so-called "Microsat" series of spacecraft. Weighing in at a rather hefty 42.5 kilograms (93.7 lb), it was launched into a 97-degree inclination, "Sun synchronous" polar orbit as an auxiliary payload aboard an Indian Polar Satellite Launch Vehicle (PSLV-6) on May 5, 2005 by the Indian Space Research Organization (ISRO). VO-52 shared the launch vehicle with CARTOSAT-1, an Indian Remote Sensing satellite, which itself weighed in at a whopping 1,560 kilograms (3,440 lb).

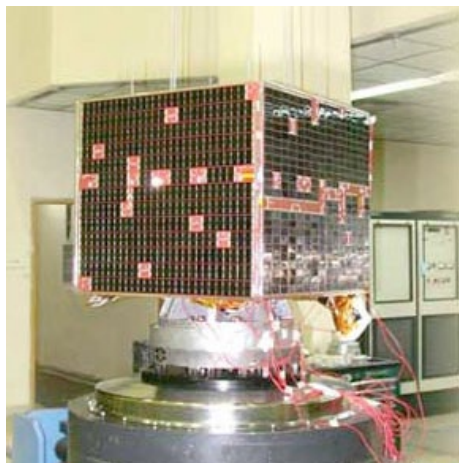

VO-52 sits atop its carrying structure just prior to integration into its PSLV-6 launch vehicle. (Courtesy: AMSAT-India)

VO-52 was India's first-ever contribution to the international Amateur Radio community and was intended to bring ISRO's satellite services within easier reach of the "common man" while also popularizing space technology among the masses. What's more, VO-52 met a

long-felt need for the Amateur Radio satellite operators in the South Asian region.

❖ What's a "Sun Synchronous" Orbit?

As VO-52 (along with many other amateur satellites) share this type of orbit, it's important to know what this term means. A *Sun-synchronous orbit (sometimes called a heliosynchronous orbit)* is an orbit which combines altitude and inclination in

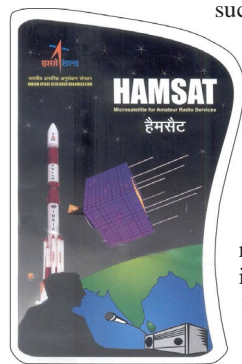

A sticker commemorating the launch of HAMSAT was widely circulated among Indian hams. The satellite later became VO-52 on orbit. (Courtesy: AMSAT-India)

such a way that objects in that orbit appear over the same point of the Earth's surface at approximately the same local "sun time" each day. Satellites that need consistent lighting, such as those that image the Earth's surface in visible or infrared wavelengths (like weather and spy satellites) or for other remote sensing purposes (such as those carrying ocean or atmospheric remote sensing instruments) are routinely launched into Sun synchronous orbits.

❖ Structure

VO-52 consists of a cube-like structure measuring 630 mm X 630 mm X 550 mm (25 inches X 25 inches X 22 inches) made up of aluminum honeycombs. Passive thermal control is achieved by spinning the satellite at a rate of about 4 RPM with a ± 3 degree spin axis orientation. A tri-axial magnetometer with

sun sensors and magnetic torquers act as actuators to provide the required inputs to the spacecraft's onboard electronics, all of which keep the satellite

correctly oriented in space. Body mounted solar panels and COTS (Commercial Off The Shelf) Lithium-Ion batteries provide the main sources of onboard power. Multi-element turnstile antennas are also shared between VO-52's transponders and for transmitting downlink telemetry.

❖ Transponders

VO-52 carries two linear (analog) inverting transponders. William Leijenaar, PE1RAH, a Dutch Radio Amateur and graduate engineering student at the Higher Technical Institute at Venlo in the Netherlands, built the first transponder. Amateur Radio enthusiasts and others at ISRO built the spacecraft's other transponder.

Both transponders operate in Mode U/V (Mode B) with uplinks at 435 MHz and downlinks at 145 MHz (see table). An unmodulated carrier on 145.936 MHz identifies the Indian transponder while the Dutch transponder emits a CW signal on 145.860 MHz. The output power of both transponders is about 1 Watt. Transponder bandwidth is approximately 60 kHz for the Indian transponder and 50 kHz for the Dutch transponder. Unfortunately, there's not enough spacecraft power to run both transponders simultaneously, so only one transponder can be activated at a time.

❖ How, When and Where to Listen

Since its launch in 2005, VO-52 has become yet another popular linear (analog) Amateur Radio satellite. Its one-watt transponders and turnstile antennas provide surprisingly strong downlink signals...even for those using modest satellite antenna arrays.

However, because VO-52 is in a relatively low, 646 X 607 km (about 401 X 377 mile) orbit, it appears to be moving a *lot* faster than most other so-called "low Earth" amateur radio satellites. This translates into a somewhat smaller footprint on the Earth, somewhat reduced access times (on the order of only about 15 minutes or so on each pass) and *far* more noticeable Doppler shifts on both uplink and downlink signals. This also means that you'll need to keep a fresh set of Keplerian elements running in your satellite tracking software to make absolutely sure your timing is correct to catch the satellite's entire pass at your location.

As with operation on our other linear satellites, when VO-52 first pops over the horizon, I set my *downlink* frequency in the middle of the

VO52 FREQUENCY AND MODE DATA:

MODE	UPLINK (MHz)	DOWNLINK (MHz)	BEACONS (MHz)
U/V (Indian)	435.220 - 435.280	145.930 - 145.870	145.936 MHz (Carrier)
U/V (Dutch)	435.225 - 435.275	145.925 - 145.875	145.860 MHz (CW)

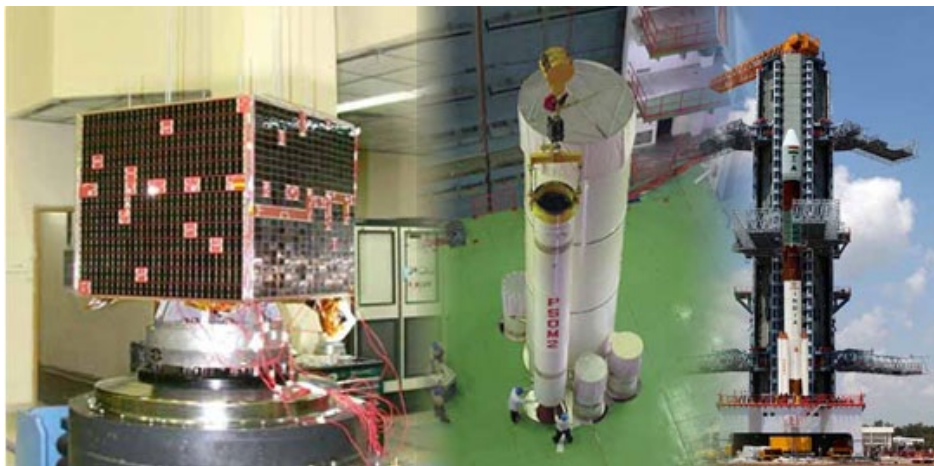

A photomontage showing VO-52 and its PSLV-6 launch vehicle prior to launch. (Courtesy: AMSAT-India)

passband (at, say 145.900 MHz) and then send a few widely spaced CW “dits” on the uplink while tuning the frequency of my uplink signal around. Once I hear my own “dits” coming back to me on the downlink, I immediately know I’m getting into the bird and I can then start actively looking for a contact.

Clearly, our Indian and Dutch counterparts have done a superb job in building and launching this satellite. Hopefully, VO-52 will prove to be the first in a long line of satellites built and launched by AMSAT-India with the help of the ISRO. More information about VO-52 and AMSAT-India can be found on their Web site at: <http://www.amsatindia.org>.

❖ ARISSAT-1 Update

In a number of recent *Sky Surfing* columns, I’ve been keeping you apprized of the very latest status of AMSAT’s newest satellite, ARISSat-1. As of this writing (early December 2011) the satellite was still functioning remarkably well, despite the fact that its on-board battery was all but dead and most of the bottom-mounted UHF receiving antenna had apparently been torn off sometime between when the satellite was shipped to Russia and its eventual launch from the International Space Station.

Fortunately, much like AMSAT-OSCAR 7, ARISSat-1’s battery failed in the “open” condition. That is, rather than shorting out power coming from its solar panels, when ARISSat-1 is illuminated by sunlight the satellite’s onboard computer resets and its various transponders turn back on until the bird once again goes into eclipse.

To date, ARISSat-1’s handlers have received hundreds of signal reports from both students and hams (and student-hams!) from around the world. Its near-real-time telemetry system was also working quite well, thanks to the many ground stations that have been receiving and then passing along that information to Doug Quagliana’s (KA2UPW/5) telemetry server at www.arissat1m.org/mobile. In addition, many of ARISSat-1’s downlinked Slow Scan Television frames featuring various images of the Earth snapped by its onboard cameras have since been uploaded to an SSTV

image gallery at: www.amsat.org/amsat/ariss/sstv.

What’s more, hundreds of people have been accumulating “secret words” from the satellite’s onboard voice message bank and were also busy deciphering downlinked CW call signs of the many people who have contributed to the amateur satellite program over the years. Whoever copies and submits the most secret words and/or correctly deciphers the most call signs received from ARISSat-1 will be recognized with a handsome award from the ARISSat-1 team.

Assuming all continues to go as planned, it now appears ARISSat-1 will re-enter the Earth’s atmosphere sometime in the March or April 2012 time frame. When that happens, some lucky predictor in the ARISSat-1 team’s “Chicken Little” contest will also be recognized with yet *another* handsome award!

The very latest news about when, where and how to listen (or otherwise participate) in this highly successful amateur satellite mission can always be found at: www.arissat.org or via the main AMSAT web site at www.amsat.org.

❖ AMSAT’s Next Project

Now that ARISat-1 has been successfully deployed, AMSAT has begun work in earnest on their next big project called “Fox.” As I noted in an earlier column, AMSAT’s satellites have often been given various names before they were launched. Since the very earliest days of satellite building, AMSAT-North America (AMSAT-NA) has simply dubbed their satellites with successive letters of the phonetic alphabet. For example, prior to its launch in 2004, the fifth satellite in this series (which later became AO-51 on orbit) was often referred to as “Echo.” So, in keeping with that tradition, AMSAT-NA’s newest satellite project is being called “AMSAT Fox” or just “The Fox Project.”

In reality, Fox will consist of a whole family of tiny satellites called Cubesats. The Cubesat idea was the brainchild of longtime AMSAT

member and Professor Emeritus Robert (Bob) Twiggs, KE6QMD, from Stanford University along with Jordi Puig-Suari of California Polytechnic State University. Together, they created the Cubesat standard for small, so-called “Nanosatellites” measuring no more than about 4 inches on a side. They also developed a spring-loaded launching mechanism (called a “Pea Pod”) for ejecting these tiny satellites from the upper stages of various launch vehicles.

❖ Fox Details

AMSAT’s first Cubesat effort (called “Fox-1”) is slated to be a simple FM “bent pipe” transponder replacement for AMSAT-NA’s currently ailing AO-51 spacecraft. Due to further advances in miniaturizing both electronics and other spacecraft components since AO-51 was launched, Fox-1 is slated to offer users much the same on-orbit capabilities (output power, receiver sensitivity, etc.) as AO-51 now does. A follow-on effort (dubbed “Fox-2”) will sport more sophisticated power and Software Defined Transponder (SDX) communications systems.

If all goes as planned (and that’s a very big “if”) look for a possible launch of Fox-1 sometime in the 2013 time frame. In the meantime, all the very latest happenings surrounding AMSAT’s new Fox project can always be found on the AMSAT-NA Web site at: www.amsat.org/amsat-new/fox.

❖ Looking Ahead

That’s all for this time. In future columns, I’ll be keeping you up-to-date on all the latest developments about Fox as well as taking a look back at some interesting early history of various projects that first took Amateur Radio into space. See you then.



AMSAT has developed an innovative new logo for the Fox Project. (Courtesy: AMSAT)

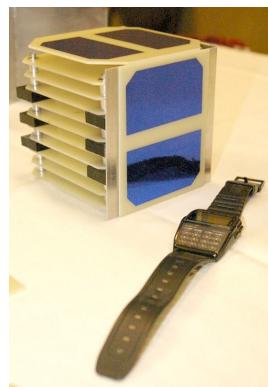

A full-scale structural engineering mockup of the Fox-1 satellite showing its multiple internal circuit board locations. Note the wristwatch used for size comparison. (KB1SF Photo)



The author’s wife (Kate, KB1OGF/VA3OGF) holds a full scale structural engineering mockup of the Fox-1 Satellite at the 2011 AMSAT-NA Space Symposium in San Jose, California. (KB1SF Photo)

Over the Air TV DXing in the Digital Era

By Mario Filippi N2HUN

No question about it, analog TV signals, with a few exceptions, are gone forever from the TV screen. As a kid growing up in the New York Metro area in the 1950s, I can remember turning the television dial to Channels 6 and 8, which 99% of the time were blank, but on certain days would magically come alive with some distant station.

If the TV's amplifier circuitry was kind enough and the propagation deities were in a beneficent mood, one of those channels would be viewable long enough to catch a fading, fuzzy fragment of the *Happy the Clown Show* emanating from some distant station's transmitter tower. Undoubtedly, something in my genetic makeup programmed me to hunt elusive, distant, signals from the very start of life.

From the early 1980s up to about the time of digital TV's roll-out, analog DXing was conducted at my shack using a VHF/UHF TV antenna mounted in the attic. This skyhook setup was sufficient for snagging long-haul DX stations as far away as Florida and on occasion, the Midwest.

Then came digital TV and the shift of most frequencies to the UHF region of the spectrum. TV circuitry also adapted to the new technology and the "boob tube" became the ultimate arbiter of what signals were worthy of passage to the picture tube. Alas, that old indoor antenna system of mine could not adequately perform in the new digital environment and it was time to make some changes.

Out with the Old, In With the New

Unfortunately, the old-time TV-Radio repair shops in my area are also long gone, so a considerable amount of data mining was spent on the Internet in pursuit of an antenna worthy of fetching signals strong enough to pass the TV amplifier's muster. My QTH is located betwixt two major metro areas in a "fringe" area about 40-50 miles equidistant from New York City and Philadelphia. So I carefully selected an antenna system that hopefully would be suitable to allow me to receive channels from those two locations.

After two years of experimentation with different antennas, and many trips up and down the ladder to the roof, I had assembled decent system. See Photo 1.

The pizza pie-shaped antenna in the photo is a Radio Shack omnidirectional VHF/UHF amplified antenna, and the one below is a UHF four-bay cage bidirectional antenna with a preamplifier. RG/6 coax is used throughout



Photo 1. My antenna system, an omnidirectional mounted atop a 4-bay cage bidirectional. Both perform adequately for local reception and also serve up some TV DX when favorable conditions exist. Both have preamps to achieve decent reception.

to minimize signal loss. With this setup I can receive about 55-60 digital channels from the New York-Philly corridor. However, when DX conditions exist both antennas get pressed into service and I'll switch back and forth between the two.

Digital TV Dawns, the Fun is Over (?)

One feature most modern digital TV receivers and converter boxes possess is a scan/search function. See Photo 2. This is absolutely one of the best improvements brought on from the advent of digital signal technology. Pressing the Scan (some call it Autoscan) button will start a search for all available TV channels in your area. This feature is handy to snag those elusive DX stations

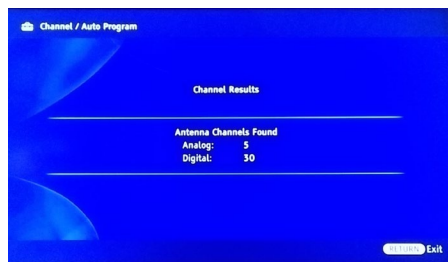

Photo 2. TV's Autoscan feature will search for available channels. This is a great tool for DXing as the TV will do all the work and search the spectrum for signals, much like your tablet scanner does. Note the presence of analog signals; some still exist in my viewing area.

Another feature desirable for DXing is a built-in signal strength meter. See Photo 3. Not all receivers possess this ability, so check your Owner's Manual. Aiming an antenna in the direction of the DX station will maximize your success, especially if you have a rotor.



Photo 3. When purchasing a TV or converter box, check to see if it has a built-in signal strength meter, invaluable when aiming your antenna. The one below has the actual channel frequency, albeit in kilohertz, along with other useful information.

However, a rotor mounted antenna is not absolutely necessary for reception of distant DX stations. As a matter of fact, your existing antenna system might yield great results, so give your existing system a whirl. My humble omni- and bidirectional antennas mounted to the chimney have plucked stations out of the ether as far away as a hundred miles or so.

DX is Alive and Well in the Ether

Analog TV sentimentalists and melancholics arise and be counted! Have no fear: digital TV has not left us DXers out in the cold. It is alive and well and I am prepared to present evidence to prove my case with actual screen shots of fetches from far away.

Most of the TV DX at this location consists of short hops of perhaps a hundred or so miles, and the optimal time for hunting appears to be from 6:00am to 9:00 am. Early morning ground fog, for some reason, appears to increase my chances of success. See Photo 4.

Late spring to early fall are the best times of the year for snagging distant stations, and signals last from 5 to 15 minutes. When band conditions are favorable my *modus operandi* is to hit the TV's scan function quite frequently over an hour or so, capture any DX stations using the TV's



Photo 4. Morning ground fog, 9/13/2011. This almost guarantees DX is rolling in, and it did, as I logged a station from the Delmarva Peninsula that morning. I term this “Rush Hour DXing” as it occurs roughly 6:00-9:00 am.

“Freeze Pane” option, then digitally photograph my televised trophy for posterity.

Proof is in the Puddin': Reeling in DX

Over the past two years, TV DXing from this Central Jersey QTH has yielded DX from three general directions: the DelMarVa Peninsula, East-Central Pennsylvania, and the lower Northeast. The duration of the signals vary and signal strength can fluctuate, causing pixilation, video fragmentation, and complete loss of the picture.

Patience and perseverance are required. Those of you who are 2 and 6 meter band enthusiasts would be right at home.

Now, one advantage of the new digital technology and unquestionably of immense value to the DXer is the ability of the TV's circuitry to display the station's call sign, program content, and resolution right on the screen. No need to wait for station identification as was done in the days of analog signals. Armed with the station's call sign, an Internet search is all that's needed to determine its location.

The DelMarVa (Delaware, Maryland, Virginia) Peninsula has been a source of DX on a number of occasions. (See **Photos 5, 6**). Stations such as WBOC, Salisbury, MD and WFDT from Arlington, VA, are about 100 and 120 miles respectively from my location – definitely short-haul DX.



Photo 5. Spanish language program on WFDC-DT, Channel 14.1 from Arlington, Va., taken on July 4, 2011. Note the call sign and program information on the top banner.

On other occasions propagation favored a Westerly direction such as occurred this past Independence Day when two stations were logged from the Lancaster and Harrisburg, Pa area. (See **Photos 7,8**). The following month, on August 17th, the Lancaster Station, WPMT was logged again, but the duration of the signal was quite short. Again, you'll increase your chances



Photo 6. WBOC broadcast received on 9/13/11, located on the DelMarVa peninsula. Note that sometimes the banner information is not displayed, so you have to wait for station ID. My TV has a “Freeze” option that suspends the picture thereby allowing you to take a nice picture. Pardon the flash glare!



Photo 7. Independence Day 2011. Early morning talk show logged from WHP, Harrisburg, Pa. Many digital broadcast stations have sub-channels but not all may show up during a band opening. Banner even displays remaining show time. The key to successful DXing is to scan, scan, scan. I am not sure what the “MY” at the end of the call sign signifies.



Photo 8. The heat is on and the DX is in. Propagation pipeline produced this pic of WPMT, Lancaster, Pennsylvania, digital channel 43.3 on July 4th. Getting good catches like this one at 7:19am EST requires that you “get up with the chickens.”

of logging DX by repetitive scanning/searching.

One opening to the Northeast occurred last fall when WTNH, channel 8.1 was logged. (See **Photo 9**). The picture suffered from video degradation due to marginal conditions, but the TV's ability to decipher the programming information allowed me to confirm the call letters.

Super-short haul DX from Atlantic City, NJ appears occasionally. (See **Photo 10**). This screen capture shows that under the right conditions, Closed Captioning text will appear. WMCN, Channel 44.1, a distance of about 70 miles, was logged on August 15, 2010.

Go Forth and Scan

My hope in writing this article is to inspire



Photo 9. My first digital TV DX. From the Northeast, WTNH, Connecticut, Channel 8.1, with video fragmentation due to sub-optimal band conditions. If you snooze, you lose, as this station was snagged at 6:30 am EST. This experience rekindled my interest in the hobby. Looks like they are in the midst of a heat wave!

those of you who've given up on TV DXing to consider giving it a second look. Hook up that old, unused antenna that's been collecting dust up the attic or that's out under the pile of rubble in the garage or back yard. Get ahold of some decent coax and connect it up to the TV. Try scanning for TV signals at different times of the day and see what's on. You may be in for a pleasant surprise. Good DXing!



Photo 10. Religious program on WMCN, Atlantic City, NJ. Note the Close Captioning text.

Is your local bookstore closing?

Get Monitoring Times direct and save money!

Subscribe TODAY and save \$4.20 PER ISSUE!

A Subscription to MT is only \$32.95 per year!

ORDER TODAY!

www.monitoringtimes.com
www.grove-ent.com
800-438-8155
828-837-2216 (fax)
order@grove-ent.com

Alinco DJ-G7T Hand-Held, Tri-band Transceiver

By Bob Grove, W8JHD

The universal appeal of a compact, hand-held radio is well acknowledged. Whether it's a telephone, a ham radio set, a fireman's or police officer's radio, or a scanner, clutching one of these is reassuring. Instant communication, a market well attended by myriad manufacturers.

Alinco's recent entry into the fray is well placed. The DJ-G7T is compact (2.33 inches wide, 4.5 inches high, and 1.25 inches deep) and weighs 9.5 ounces. It comes equipped with a Li-Ion battery, rubber whip, drop-in charger with 120 VAC/12 VDC adapter, belt clip, hand strap, and a comprehensive, 113 page manual.

A top-of-the-case, water-tight jack is provided for an optional earphone/microphone combination. An SMA connector is used to attach the antenna.

So what makes this radio stand out in the crowd? First, it's a tri-bander, transmitting in the 144-148, 430-450, and 1240-1300 MHz ham bands. Second, it has continuous reception coverage from 530 kHz-1300 MHz (cellular blocked) in AM, FM, and WFM modes.

This offers the dual capability of licensed amateur radio service as well as scanning the spectrum for monitoring broadcast signals and two-way VHF/UHF communications. Tuning steps in the VFO mode may be chosen as 5.0, 6.25, 8.33, 10, 12.5, 15, 20, 25, 30, 50, 100, 125, 150, 200, 500, and 1000 kHz.

Pressing the transmit button when non-ham frequencies are selected will bring up a "Disabled..." message and the transmit attempt will be ignored.

The keypad is intuitive to follow and allows a large number of options available to the operator.

A 'scope function permits a spectrum display of signals present within +/-30 kHz of the displayed frequency. A top-panel knob may be rotated to slew the frequency bands. Discrete frequencies may also be entered directly from the keypad.

It is also possible to start a scan sequence and watch the signals drift by as the frequencies shift. The sequence can pause automatically as a busy spike passes the center of the screen to be monitored, then the sequence activated again with the scan key.

The keypad is a busy place, but it's well marked with its functional responsibilities:



- 1 This wild key allows assignment of user-chosen memory functions
- 2 Transmit power selection (multiple values from 0.3-5 watts)*
- 3 Signal attenuation for strong-signal environments (four levels)
- 4 Modes may be chosen for AM, NFM, or WFM modulation
- 5 CTCSS tone squelch, digital code squelch (DCS), or modulate-carriers may be selected or cancelled
- 6 The channel scope shows a selectable switch of spectrum with signal spikes**

- 7 Step intervals for slewing across a reception band
- 8 Microphone gain may be adjusted to suit the environment (four levels)
- 9 Press to recall the channel that was previously selected
- 0 Priority frequently samples important frequencies for activity
- . The decimal key is used in direct frequency input as well as clearing memory channels
- ENT Is used to determine input/output frequency separation on a repeater
- MAIN Allows switching between main frequency band and the dual/mono band
- SUB Switches between the sub band frequencies and dual/mono band frequencies
- V/P/M Alternates memory registration, editing, and naming
- SCAN Is the standard automatic sequencing of memory channels to find activity
- FUNC Selects the second function of each key

* Power levels vary with use of internal battery or external DC source, and band chosen.

** Spectrum displayed is 11 adjacent frequencies or memory channels

A side-located pushbutton powers on the rig, and it's rather cantankerous. Roughly 1/4 inch in diameter, hard-rubber covered, and flush with the case, depressing it with a thumb is impossible, and with a finger tip unlikely. Pressing it substantially with my fingernail was the only way I could activate it.

But once it's activated, the green-lit LCD display reveals its information. Two frequencies, one from the primary and the other from the secondary receivers, may be displayed. The multi-purpose, concentric controls on the G7T's top can be rotated to change those frequencies and also serve to control squelch and volume levels.

A sampling of the LCD window shows the familiar lockout key symbol to prevent

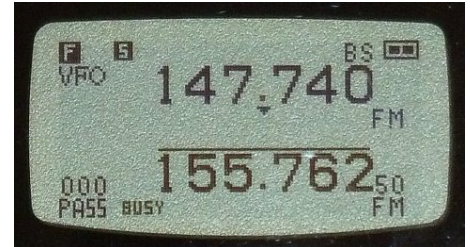

accidental or intentional resets. Battery condition charge level is also revealed by the standard cell segments symbols. ATT reminds you that you've activated the attenuator when you can't figure out why signals sound so weak. Relative signal strengths are revealed by a bar graph.

Audio clarity is excellent; no tininess as familiar on many teensy speakers, and voice contoured to reduce extraneous hiss. At loud levels, the voice is clear and undistorted.

In strong-signal environments, an attenuator with four successive levels of signal-strength suppression may be selected to reduce adjacent-channel interference.

❖ Menu Settings

The G7T offers a considerable number of menu options to customize your personal settings. These include power source, screen appearance, sounds, transmitter keying, receiver settings, memory characteristics, scanning functions, and keypad assignments.

❖ Flexible Memory

The G7T has seven memory banks:

1. General (Stores and recalls up to 1000 frequencies)
2. Program Scan (Searches between a span of frequencies)
3. Dual Frequency (Memorizes up to 100 pairs of frequencies)
4. Priority Scan (Favors up to 100 frequencies for preferred recall)
5. Call Channels (Registers frequencies to be used for calling)
6. Search Pass (Allows skipping up to 100 frequencies during search)
7. Transmitter Detection (Memorizes up to 100 found frequencies during search)

Additionally, a permanent memory of commonly-used bugging frequencies may be interrogated for activity.

Memory channels can be moved from one bank to another. Channel identification may be displayed and described alphanumerically with up to 16 letters and numbers.



❖ Scanning

In the VFO mode, scanning across a selected band can be customized by choosing the step size. A custom range of frequencies may also be programmed. The scan function will also work in memory banks and presets.

During any of the scan sequences, scanning can be stopped by simply pressing the push-to-talk (PTT) button. Pressing the function (FUNC), SCAN, or W/P/M key will also stop the scan sequence.

But the G7T is foremost a transceiver, and secondarily a scanner. Scan speed is a sluggish five or six channels per second compared to the lightning-fast 100-200 steps per second of a Uniden dedicated scanner.

Determining the squelch tone or DCS code being used by a transmitter is done automatically by selecting the Tone Scan or DCS Scan function. When operating, the display will show the progressive standard tones or codes in rapid order, then stop when the correct tone frequency or code has been resolved. A beep will confirm the find.

❖ Transmitter Detector

Not really a bug finder, this interesting feature allows you to enter a discrete frequency, then change your location while listening to the pulsing tone. As you get closer, and thus the signal gets stronger, the tone will pulse faster.

While this function does not allow listening to the contents of the transmitted signal, that can be heard by pressing the monitor key (MON).

Using a directional antenna will help with direction finding. If the signal gets closer (stronger), the attenuator can be called into use to prevent overloading the detector and confounding the pulse tone.

This is a good gimmick for radio fox hunts, and can act as a bug detector if the frequency of the hidden transmitter is known.

❖ Bug Detection

The G7T does include a method for searching for surreptitious listening devices. A special memory consists of known frequencies utilized by bug manufacturers. By invoking that function, the scanning sequence will search for activity on those known frequencies.

If a signal is discovered a "DETECT!" message will show on the screen accompanied by an unpleasant sound from the speaker (or earphone if used for stealth). The sound grows louder as the signal source is approached.

❖ The Bottom Line

The Alinco DJ-G7T is well thought out, cleverly designed, and highly functional. It has the reassuring feel of a substantial "brick," and the white-against-black key legends are easy to read.

Naturally, multifunction keys and sub-menus take a while to learn, but it's the only way a limited-size piece of equipment with multiple functions can operate.

The Alinco DJ-G7T lists for \$289.95 and is available from MT advertisers.

SPECIFICATIONS

Receive Frequency Range: 530 kHz-1299.995 MHz (Cellular Blocked)
Transmit Frequency Range: 144-147.995, 430-449.995, 1240-1299.995 MHz
Antenna: 6-1/2 inch rubber, SMA base, 50 ohm impedance
Operating Voltage: 7.4 VDC (Li-Ion battery pack supplied)/4.5-16 VDC external supply
Current Consumption: 1.8 A max (430 MHz transmit)/200 mA receive/56 mA battery save
Operating Temperature Range: +12 to +113 degrees F
Frequency Stability: +2.5 parts per million (-10 to +45 degrees C)
Dimensions (Excluding Projections): 2.35 inches W x 4.53 inches H x 1.18 inches D
Weight: 9.55 oz.
RF Output Power (Approximate): 144/430 MHz, 5/2/1/0.3 W; 1200 MHz, 1/0.3 W
Modulation Modes: 5 kHz FM deviation transmit; FM, AM, WFM receive
Spurious Transmit Emissions: -60 dB or less
Receive System: Double conversion superheterodyne (single conversion on WFM)
First And Second IF: Main band FM, 51.65 MHz/450 kHz; Sub band AM/FM, 50.75 MHz/450 kHz; Sub band WFM, 10.7 MHz
Sensitivity: -15 dBu typical on main band
Selectivity (-6/-60 dB): AM/FM, 12/35 kHz; WFM, 130/300 kHz
Audio Output Power: 400 mW at 8 ohms, 10 percent THD

CC GOZO AM/FM Radio

By Larry Van Horn, N5FPW

The C.Crane Company has an impeccable reputation for providing consumer-driven radio products, and their newest entry, the CC GOZO AM/FM radio, is another in a long line of electronic hits.

The hallmark of this newly-introduced radio is high audio fidelity normally found in more expensive desktop radios. Voice replication is clear and precise while delivering natural sounding vocals. This is accomplished with an additional passive radiator speaker. C. Crane says this is the first radio in their line that was specifically developed for high fidelity audio.

Although it doesn't pull in weak AM stations as well as some of the other C.Crane radios I have tested, the FM reception on the test unit was very good. I was receiving FM stations with full quieting from Nashville, Tennessee more than



200 miles away using the whip antenna included with the radio.

This radio is the epitome of simplicity: an ON/OFF knob, a TONE knob, an AM/FM/AUX knob, and a large tuning knob on a backlit analog dial. The dial light turns off 11 seconds after the power is turned on, the band is changed or the tuning is adjusted. That's all the controls you get and it's really all you will need with this radio.

On the rear panel there's an MP3/AUX input should you wish to plug your MP3 player or smartphone into the radio to share your music using the radio's robust speaker. They have included a short cable for use with an iPod/MP3 player or other aux input device. The other two jacks on the rear panel include a headphone jack for personal listening (no headphones or buds included) and the input jack for the AC adapter.

Powered with six AA batteries for portable use, the company says new alkaline batteries rated at 2500 mAh will last for 12 hours at a moderate volume level. The unit does come with an AC adapter that is a linear wall transformer power supply, so there is no noise from the supply as there can be with switching supplies.

The CC GOZO is only 7.5 inch wide x 4.5 inches high and 3.25 inches deep. It weighs 1.5 pounds (without batteries), and the 2.25 inch six ohm speaker puts out 10 Watts.

The CC GOZO is a unique AM/FM radio with audio that is best described as surprisingly full, pleasant and bright. The cabinet has a nice solid feel and the operating controls all work smoothly, although the main tuning is a bit stiff on the unit we tested. At \$109.95, the CC GOZO gives you the quality of more expensive desktop radios in a size that is flexible for home, boat, or RV.

You can get more details on the company website www.ccrane.com or phone them from the U.S. and Canada at 1-800-522-8863. Local and international callers should use (707) 725-9000.

SPECIFICATIONS

Input Power: AC Adapter: 12 VDC 650 mA tip positive or (6) AA size (not included)
Power Consumption: AM 3.5W, FM 4W
Audio Output: 3.5W
Speaker: 2 .25 inches, 6 Ohms, 10 Watts
Frequency Coverage: AM 520 - 1710 kHz, FM 87 - 108 MHz
AM Antenna: Internal Ferrite Bar, FM Antenna: Telescopic whip antenna
AM Sensitivity: $\leq 3\text{mV}$ (S/N=20dB)
FM Sensitivity: $\leq 3\text{uV}$ (S/N=30dB)
AM Selectivity: $\geq 25\text{dB}$ ($\pm 10\text{kHz}$)
FM Selectivity: $\geq 40\text{dB}$ ($\pm 400\text{kHz}$)
One Signal Selectivity: $\geq 30\text{dB}$
Earphone Jack: 1/8 inch (3.5mm) Stereo 32 ohm
Aux in Jack: 1/8 inch (3.5 mm) stereo
Dimensions: 7.3 inch W x 4.2 inch H x 3.25 inch D
Weight: Approximately 1.5 lbs without batteries.
Warranty: One Year Limited Warranty
Included Accessories: AC Adapter and Manual
Note: Specifications are subject to change without notice.

What's NEW

Tell them you saw it in Monitoring Times

Larry Van Horn, New Products Editor

How to Listen to the World

How to Listen to the World by Ken Reitz KS4ZR is a new Kindle e-book now available online from Amazon.com. It is an introduction to shortwave listening, amateur radio, Free-to-Air satellite TV/radio, AM-FM DX, Internet radio and the new phenomenon of cord-cutting – getting off the addiction to cable and satellite-TV.

Much of the material for Ken's new missive is from columns and feature articles written over the last two years here in the pages of *Monitoring Times*. Each section has been updated to include the latest information available with over 100 links to the most important websites for each topic.

Topics covered in this new Kindle e-book include: Getting Started in Shortwave Listening; Buying Your First Shortwave Radio; Chasing DRM: The Elusive Dream of Digital Audio on Shortwave; A Look at Three New Shortwave Radios; The Best of the Cheap Shortwave Portables; Listening to Shortwave Radio in Your Car; Weather Facsimile via Shortwave on Your iPad; Radio Pirates: The intriguing world of unlicensed broadcasting; Amateur Radio for Everybody; Getting Your License; Getting Started on HF Part 1; Getting Started on HF Part 2: Chasing DX; Getting Started on HF Part 3: QSL those Contacts!; Shortwave and Ham Antennas for the less Financially Endowed; Loop your way to HF DX Success; The Joys of Ten Meters; Digital Operating on the Ham Bands; Tuning in to the International Space Station; Whatever Happened to TVRO?; The Newest FTA Receiver: Manhattan RS1933; AM-FM-TV DX; FM-HD: A Long and Winding Road; A Cord-Cutter's Primer; and Internet Radio Listening in a Non-FIOS Home.

Previously unpublished material has also been added to give a fuller understanding of each topic.

A freelance writer since 1988, Ken Reitz holds an Extra Class license under the call sign KS4ZR. He is the features editor here at *Monitoring Times* and also writes our *Communications* and *Beginner's Corner* columns.

You can order this Kindle e-book from Amazon for \$2.99 by pointing your browser to the following link <http://tinyurl.com/7w82qw5>. Kindle e-books can be read on any e-reader, laptop, desktop, smartphone or tablet.

AOR ARL2300 Ethernet Controller

AOR USA, Inc. recently released its new ARL2300 remote control monitoring system that



enables complete remote control of its AR2300 and AR5001D "black box" wide coverage receivers. With a high speed internet connection, the ARL2300 allows long distance computer operation of these two professional grade communications receivers in real time. The ARL2300 Ethernet Controller also has an option which allows remote control and remote listening through a local network.

It can be used for various professional or law enforcement related applications which demand interception of radio communications or radio wave monitoring from a remote location.

The client software is based on the Java 2 platform and requires version 1.6 (Java SE 6 runtime) or higher to be installed on the PC on which it is running. The settings of ARL2300 can be easily changed through the local network (DHCP mode) by using a browser, based on Apple's "Zero configuration" software Bonjour.

Control functions include changing the frequency, bandwidth and receive mode; selecting the sampling rate, a preset VFO memory, attenuator and amplifier; and adjustments to the volume and squelch control.

The ARL2300 is sold by Grove Enterprises for \$899.95 plus shipping and you can get more information online at www.grove-ent.com/ARL2300.html.

DXE QSL Scanning Kit

DX Engineering is now offering the radio hobbyist a solution to help manage your ever-growing QSL card collection. The DXE QSL Scanning kit is able to store your cards and display them in rotation on an attractive, compact screen. The kit consists of one compact digital scanner, a seven-inch LCD digital picture frame screen, plug-in power supplies and a 2MB SD card.

To operate, feed QSL cards individually through the scanner. A slider guide adjusts easily to accommodate non-standard QSL sizes. The scanner accepts card sizes from 2 x 2 inches to a



maximum of 4 by 6 inches, and images are saved in JPEG format. A PC is not required for the scanning process. To view the QSLs, simply plug the SD memory card into the digital picture frame. It's great for the hamshack, living room or office.

Reminisce about past QSOs or show off your collection to your friends. Up to 2000 QSL cards images can be stored on the included SD card – more with larger capacity memory cards. Reclaim your wall space for DXCC and WAS certificates.

The DXE-QSL Kit sells for \$89.95. For more information, contact DX Engineering, P.O. Box 1491, Akron, Oh 44309; 800-777-0730 or visit them on the web at www.dxengineering.com.

New Handheld Slated for Release

In early 2012, Uniden plans to start shipping its newest handheld scanner, the BC125AT. Touting 500 channels in 10 banks, the BC125AT includes full VHF and UHF coverage (25-54 MHz, 108-174 MHz, 225-380 MHz, and 400-512 MHz), including Air and Military Air channels, as well as full alpha tagging for all channels. PC programmability makes it simple to quickly program for events such as air shows, auto racing, boat racing, and more.

Close Call® RF Capture, including Do-Not-Disturb, makes capturing those unknown frequencies a snap. Plus, Uniden has extended the Do-Not-Disturb function to include Priority channels, so that annoying interruptions from priority or Close Call checks is a thing of the past.

The BC125AT includes feature enhancements including Temporary Lockout, CTCSS/DCS decoding, per-channel dropout delay, and complete search features, all in a compact, easy-to-carry chassis. Weather priority and weather alert will also keep you informed as to the latest weather and other hazards as announced by the National Weather Service.

Since FCC Type Acceptance has not yet been issued for this scanner, we do not have current pricing and the unit may not be offered for sale.

Nothing in this article should be construed as an offer to sell the product and any such offering will be contingent on receipt of a FCC Grant.



Books and equipment for announcement or review should be sent to What's New, c/o Monitoring Times, 7540 Highway 64 West, Brasstown, NC 28902. Press releases may be faxed to 828-837-2216 or emailed to Larry Van Horn, larryvanhorn@monitoringtimes.com.

When ordering or inquiring about the products mentioned in this column, be sure to tell them that you saw it in the pages of *Monitoring Times* magazine.

WORLD RADIO TV HANDBOOK

WRTH 2012

We are very pleased to announce the publication of the 2012 edition of *World Radio TV Handbook*, the bestselling directory of global broadcasting on LW, MW, SW & FM

The Features section has a history of radio on Tristan da Cunha, reviews of the latest equipment, an explanation of receiver testing terms and techniques, a visit to Radio Bulgaria, and other articles and items, including our regular *Digital Update*.

The remaining pages are, as usual, full of information on:

- National and International broadcasts and broadcasters by country with frequencies, powers, languages, contacts, and more, including Clandestine and other target broadcasters
- MW frequency listings by region. International and domestic SW frequency listings, as well as DRM listings
- International SW broadcasts in English, French, German, Portuguese & Spanish.
- Reference section with Transmitter locations, DX clubs, Internet Resources, and much more

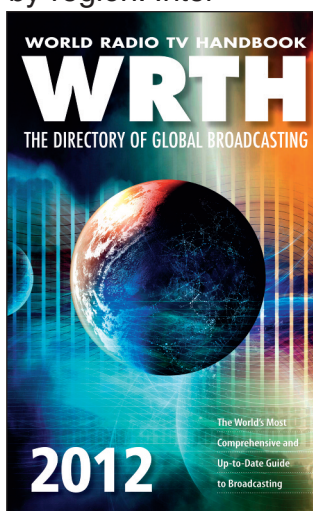

Available December 2011

SOME COMMENTS ON WRTH 2011

With 50 years of WRTH under my belt I still look forward to the next year's volume appearing, thank you for your ongoing effort in producing this invaluable reference work – *Roger Bunney, UK*

The World Radio TV Handbook has consistently set the gold standard in broadcast reference information and it remains the very best, most authoritative, and comprehensive reference book in the broadcast world – *Gayle van Horn, Monitoring Times*

I still am convinced that your publication is awesome! – *Gérard Koopal, The Netherlands*

The handbook seems nearly perfect – *Wolfgang Bueschel, Germany*

As always, we highly recommend WRTH as excellent value for money, and a must-have for both the hobby listener and the broadcast professional – *Andy Sennitt, Radio Netherlands Worldwide*

WRTH was always and still is one of the most important sources of fresh broadcast information – *Mieczyslaw Pietruski, Poland*

Thanks for another excellent edition of our "bible" – *Günter Lorenz, Germany*

The WRTH is fantastic. You really stand alone in the data department – *Larry Beavers, USA*

Congratulations for WRTH 2011 - the definitive radio guide. It is fascinating and essential reading – *Mike Terry, UK*

"WRTH" has been my best friend in my radio adventures for the last 20 years and it will continue to be so for many years to come – *Gianfranco Buonomo*

A "must have" reference for any SWL – *Randall Morrison, USA*



Happy MT Readers/ Listeners

I am blind and have long envied comms hobbyist friends who've been reading *MT* over the years. I look forward to getting a taste of my first issue [of *MT Express*]. Many thanks for making *MT* available in an accessible format.

Ron Miller N6MSA

You sure have come a long way since my first subscription, which was a newspaper edition that goes back to the late 70s.

Paul Robertson (writing after an *MT Express* download problem was resolved)

Weird Antennas

Wearable, Stretchable Antenna. This wearable antenna is able to send a signal to satellites using the Cospas-Sarsat worldwide search and rescue satellite system. ESA - J. Makinen



www.popsci.com/gadgets/article/2011-09/fabric-antenna-sewn-life-vests-could-help-rescuers-find-lost

What basic antenna design does that look like? Resonant frequency?

hl4

<http://physicsworld.com/cws/article/news/47371> is a web article on a [nano]antenna that deals with visible light waves. No communication application that I noticed, but interesting

Clem Small

Received my *MT* today and saw you used my email about pizza pan antennas....great discussion....Seems these antennas would work in a number of interesting areas, such as composite aircraft, molded into the plastic, maybe useful in race cars for telemetry... I wonder if an array would be useful in radio astronomy or receiving sat signals.... The useful freqs cover the hydrogen line and the modern weather sats... Maybe that would make a good article for us astronomy guys....a back yard array of pizza pans.... A very long base line interferometer of pizza pans would make quite a sight.... Sounds like a joke, but enough of 'em just might work.... Less expensive than the huge dishes that we amateurs can't afford... I'd consider it an accomplishment to record the hydrogen line!

Michael Carroll

We have built antennas into aircraft structures, but not many readers are doing stuff like that. Also looking at a Radio Astronomy article, but the broad band pizza antennas are not what you want to use.

Looking for that weak Hydrogen line sig-

nal, while the antenna is picking up dozens of TV and FM stations is not the way you want to go. But it is nice to hear from a reader.

Kent Britain

Railroads

Hi Ernest,

As a rail fan and a scanner enthusiast, I always look forward to your *MT* columns on railroad radio. Your *Back to Basics* piece in the December issue was particularly appreciated, since it contained a lot of useful information that is always good to have handy.

My particular railroad radio interest is voice communications onboard AMTRAK passenger trains. Neither my wife nor I like to fly, and when we have to travel any great distance, we like to go by train. Our favorite AMTRAK train is the Southwest Chief, which we use whenever we travel back east to visit family in Ohio. I always have my scanner along on these trips, and include some of radio traffic I monitor in the trip reports that I later submit to the On Track On Line website (www.on-track-on-line.com/). On one particular trip, the scanner proved particularly useful when the "Chief" encountered some bad weather outside of Chicago.

Again, thank you for the railroad radio columns you've written over the years, and all the useful information they contain.

Eric Beheim

Vintage with a Vengeance

I read with interest Dan Farber's column in the December issue. I, too, have a copy of *Practical Radio*, which is a goldmine of information. I want to draw attention to the opening chapters with their description of the "Radio Game," boys dx-ing with home-brewed sets, in friendly competition.

What's fascinating is the similarity of the game with young hackers and programmers today; in both cases the younger generation knows far more than the older, which can only look on with wonder. I've used these sections when I've taught Internet culture; the relationship is uncanny. A new communications technology comes along, is quickly taken to by the young, and a whole world opens up, along with a generation gap.

My second comment concerns the book as a practical guide today. The description of loose couplers, variometers, and the like, has come in handy. I'm currently a resident at the New York City media center, Eyebeam, and I have a small show in their Window Gallery, which includes a group of early radios and antennas. These are coupled together (along with a loop antenna from an early RCA BP-10 portable); the signal is sent to a contemporary guitar amplifier. The result is a beautiful and clear cacophony of stations from all over New York. (The rest of the show deals with similar themes.) You can see

photographs here: www.flickr.com/photos/asondheim/sets/72157628198851569/ The book made these hookups possible!



Thank you greatly for the article! I really recommend the book to anyone interested in the history and technology of early history

Alan Sondheim

Good-Bye to Bert

It is with sadness to tell you that Lambert "Bert" Huneault of Windsor Ontario passed away today (Dec. 3) after a lengthy illness. You will recall that Bert submitted several articles to *Monitoring Times* mostly relating to either aviation or weather.

I visited Bert in the hospital just two days ago and we were both reminiscing about how we met back in 1980 as a result of an item he wrote in the old newspaper edition you had back then. I saw he was from Windsor and I called him regarding the article and we have been friends since that day.

He will certainly be missed by his family and many friends.

Paul Robertson

Bob Grove and Bert corresponded frequently. Bert wrote in one of his *MT* articles about manning a remote weather outpost in Canada as a young man, and the surreal feeling of hearing no signals at all on HF during a severe magnetic storm. I was reminded of that story when recently reading Roy Berger's novel *2012: Rabbits and the Happy Apocalypse on Shortwave Radio* (see p75 Nov *MT*) ... Fortunately for Bert, the signals returned after three days and he was not "alone" after all.

An obituary and guest book are available at the *Windsor Star* website (www.windsorstar.com). We at *MT* extend our condolences to all who knew this intelligent and generous man.

Rachel Baughn, Editor

This column is open to your considered comments. Opinions expressed here are not necessarily those of Monitoring Times. Your letters may be edited or shortened for clarity and length. Please mail to Letters to the Editor, 7540 Hwy 64 West, Brasstown, NC 28902 or email editor@monitoringtimes.com
 Happy monitoring!
 Rachel Baughn, Editor

SCANNER



MASTER



SCANNERS

COMMUNICATIONS RECEIVERS

ACCESSORIES & ANTENNAS

SOFTWARE



REMOTE MONITORING

PROGRAMMING

CONSULTING

SYSTEM DESIGN & INSTALLATION



www.SCANNERMASTER.com

1-800-SCANNER

THE NATION'S LEADING SCANNER DEALER - NOW IN OUR 33RD YEAR

Visit Our Boston Area Scanner Museum & Store: 260 Hopping Brook Road, Holliston, MA 01746

INDEX OF ADVERTISERS

AMSAT.....	76
Antique Wireless	63
AOR	CVR2
Kevin Carey (Longwave).....	76
C Crane.....	31
CIDX.....	76
Computer Aided Technology.....	21
Grove	11, 21, 59, 65, CVR3
ICOM	CVR4
MT Express	3, 69
NASB.....	33
Scanner Master	75
Stealth.....	76
TEAK Publishing	61
Universal Radio	57, 76
W5YI	5
WiNRADiO	1
World Radio TV Handbook	73

Reach new customers with your advertising message in *Monitoring Times*! Contact Judy Grove at 1-800-438-8155 or email judy@grove-ent.com

Stock Exchange

For information on Stock Exchange or commercial advertising, contact Judy Grove at 1-800-438-8155 or judy@grove-ent.com

Line Ads \$1 per word

Many thanks...from a lapsed subscriber. Its good to be back (my name was actually in an issue about a year ago...). Like many other users, I download the .pdf version of the Mag into iPad and open it with iBooks. Works nicely.

Craig

Subscribe to MT for as little as \$17.95 (U.S. Second Class Mail)

7540 Hwy. 64 W.; Brasstown, NC 28902
1-800-438-8155 US and Can.; 828-837-9200; Fax 828-837-2216
e-mail order@grove-ent.com

	6 months	One Year	Two Years	Three Years
Electronic Subscription	<input type="checkbox"/> \$17.95	<input type="checkbox"/> \$19.95	<input type="checkbox"/> \$38.90	<input type="checkbox"/> \$57.85
US Second Class Mail	<input type="checkbox"/> \$32.95	<input type="checkbox"/> \$59.95	<input type="checkbox"/> \$119.00	<input type="checkbox"/> \$179.95
US 1st Class Mail	<input type="checkbox"/> \$22.95*	<input type="checkbox"/> \$42.95*	<input type="checkbox"/> \$79.95*	<input type="checkbox"/> \$119.95*
Canada Surface*	<input type="checkbox"/> \$35.95*	<input type="checkbox"/> \$69.95*	<input type="checkbox"/> \$125.95*	<input type="checkbox"/> \$189.95*
Canada Air*	<input type="checkbox"/> \$30.95*	<input type="checkbox"/> \$58.95*	<input type="checkbox"/> \$119.95*	<input type="checkbox"/> \$179.95*
Foreign International*	<input type="checkbox"/> \$62.95*	<input type="checkbox"/> \$119.95*	<input type="checkbox"/> \$229.95*	<input type="checkbox"/> \$349.95*
Foreign Air*	If you order MT Print Edition AND MTXpress Electronic together, MTXpress is only \$11 per year!			

* All payments must be in US funds drawn on a US bank.

MasterCard, Visa, Discover Cards and Paypal accepted!



Used Radios for Sale - apollo11@zoominternet.net

www.dxtreme.com -- Log DXtremely with DXtreme Software!

Columnist Blogs and Web Sites

These blogs and web pages were created by some of our columnists to better serve their readers. While we highly recommend these resources, they are not official instruments of *Monitoring Times*.

AMERICAN BANDSCAN
<http://americanbandscan.blogspot.com/> - by Doug Smith

ANTENNA TOPICS
www.wa5vjb.com - by Kent Britain

BELOW 500KHZ
<http://below500khz.blogspot.com/> - by Kevin Carey

FED FILES
<http://mt-fedfiles.blogspot.com/> - by Chris Parris

LARRY'S MONITORING POST
<http://monitor-post.blogspot.com/> - by Larry Van Horn

MILCOM
<http://mt-milcom.blogspot.com/> - by Larry Van Horn

SCANNING REPORT
<http://www.signalharbor.com/> - by Dan Veeneman

SHORTWAVE
<http://mt-shortwave.blogspot.com/> - by Gayle Van Horn

UTILITY WORLD
<http://mt-utility.blogspot.com/> - by Hugh Stegman
www.ominous-valve.com/uteworld.html

STEALTH Amateur Radio

Complete Guide

- Apartments
- Condos
- CC&R Neighborhoods
- Operate from...

ANYWHERE!

stealthamateur.com

Your ad could be HERE for ONLY \$50!

Discover Longwave!

BeaconFinder II Directory

- 100's of beacons
- 75+ pages, 3-hole punched
- Covers 0-530 kHz spectrum
- \$13.95 postpaid

Sounds of Longwave

- Hear Natural Radio, Milcom, WWVB, beacons, Euro-BC, Lowfers, more!
- \$13.95 postpaid (specify CD or cassette)

Kevin Carey
Box 56, W. Bloomfield, NY 14585

We're Going Back
To Space!

AMSAT®
Join Us!

www.amsat.org
(888) FB AMSAT

Join the Club!

Open to hobbyists worldwide, the CANADIAN INTERNATIONAL DX CLUB is Canada's national, general coverage radio club serving members since 1962.

For a free sample of our monthly electronic newsletter, Messenger, please e-mail CIDX at:

cidxclub@yahoo.com
Web: www.cidx.ca

HUGE 100 PAGE CATALOG

- Shortwave & Ham Gear
- Scanners & RTTY/FAX
- Antennas & Accessories
- Radio Books & CDs.

Send \$1 to

Universal Radio

6830 Americana Pkwy.
Reynoldsburg, OH 43068
Tel. 800 431-3939
www.universal-radio.com

GROVE

Your Source for Radio Scanners, Receivers, Accessories, and Publications

AOR

AR-8600II	RCV11	\$939.95
AOR SR2000A (B)	RCV36	\$2899.95
AR2300B	RCV60	\$3,699.95
AR5001D (B)	RCV68	\$4,199.95

KAITO

KA801	RCV61	\$79.95
KA1103	RCV55	\$89.95
KA1121	RCV37	\$149.95

SANGEAN

ATS-909X (Black)	RCV67-BK	\$259.95
ATS-505P	RCV7	\$109.95
ATS-909X	RCV67	\$259.95
WFR-20	RCV40	\$239.95
WFR-1	RCV56	\$299.95

GRUNDIG

S450DLX Field Radio	RCV70	\$99.95
S350 DELUXE	RCV4	\$89.95
G3	RCV65	\$99.95
G6	RCV59	\$99.95
Satellit 750	RCV58	\$299.95

ICOM

R75	RCV32	\$669.95
R2500	RCV52	\$929.95

PERSEUS RCV57 \$1199.00

WiNRADiO

WR-G33EM	RCV16	\$849.95
WR-G33EM/GPS	RCV16/GPS	\$999.95
WR-G33WSM	RCV28	\$999.95
WR-G303e	RCV46E	\$449.95
WR-G303i	RCV46	\$359.95
WR-G303i w/ pro demodulator	RCV46-P	\$429.95
WR-G313 (Internal)	RCV31	\$1149.95
WR-G313 (External)	RCV31-E	\$1149.95
WR-G305i	RCV53	\$659.95
WR-G305i w/pro demodulator	RCV53P	\$759.95
WR-G305e	RCV63	\$619.95
WR-G305e w/pro demodulator	RCV63P	\$799.95
WR-G315 (Internal)	RCV54	\$CALL
WR-G315 (External)	RCV64	\$CALL
WR-G31 DDC Excalibur	RCV66	\$899.95
WR-G33DDC Excalibur Pro	RCV62	\$1649.95

Grove means service. You won't find better customer service anywhere. BUY TODAY!

Established in 1979 by well-known communications expert Bob Grove, Grove Enterprises has become a world leader in radio monitoring equipment, accessories, and publications.

If you decide you don't like a product, Grove Enterprises doesn't penalize you for it. There is NO restocking fee so long as you call our toll free number for a return authorization within fifteen days of shipment and the item is returned in new condition. Once the item is received we will give you credit toward another item or issue a full refund (less shipping charges). Software cannot be returned if opened.

That's it! No hassle! No negotiations! Just call 1-800-438-8155 and our friendly staff will assist you with a return authorization number.

WiNRADiO Accessories

USB Adaptor	ACC 2	\$39.95
PCMCIA PC Card	ACC 28	\$89.95
WR-BT-3500 VHF/UHF Power Injector (BIAS T)	ACC29	\$99.95
Client Server Option-G313 Series	ACC14D	\$129.95
Mounting Clamps for AX-71C	ACC71	\$14.95
WR-LWA-0130 long-wire antenna adaptor	ADP35	\$39.95
AX-71C discone antenna	ANT01	\$89.95
AX-37A wide-band log-periodic antenna	ANT28	\$389.95
AX-37AM wide-band log-periodic antenna	ANT29	\$499.95
AX-07B flexible VHF/UHF antenna	ANT47	\$27.95
AX-91M magnetic antenna base	ANT48	\$27.95
AX-81S active HF antenna	ANT51	\$189.95
WR-AX-31C	ANT58	\$169.95
AX-17C indoor active HF antenna	ANT60	\$199.95
AX-24B discone antenna	ANT63	\$349.95
WR-G3E-WMB Wall-mount Bracket for G3	BRK02	\$19.95
WR-DNC-3500 Frequency downconverter	CVR02	\$219.95
FSK Decoder	DEC01	\$449.95
WR-LNA-3500 low noise amplifier	PRE03	\$199.95
WR-PPS-G3 portable power supply for G3	PWR09	\$189.95
Digital Suite	SFT 15	\$74.95
Trunking Software	SFT 23	\$74.95
G303 Professional Demodulator	SFT20	\$119.95
WR-ATO-G305 Advanced Trunking Option	SFT56	\$179.95
WaveBase 3	SFT60	\$74.95
ERD-1500 RF Sniffer	TST06	\$49.95

Shipping/ Handling Charges

Total Order	Shipping Charges
\$1-\$19.99	\$3.00
\$20-\$49.99	\$6.95
\$50-\$99.99	\$9.95
\$100-\$399.99	\$13.95
\$400-\$899.99	\$17.95
\$900-\$1499.99	\$20.95
\$1500-\$1999.99	\$24.95
\$2000-\$2499.99	\$28.95
\$2500+	\$32.95

Make sure to visit us on the web to get the latest and greatest deals!

GROVE

(800) 438-8155

Grove Enterprises, Inc. - www.grove-ent.com

(800) 438-8155; (828) 837-9200; fax: (828) 837-2216

7540 Hwy 64 W; Brasstown, NC 28902 - email: order@grove-ent.com

Icom has the receivers for the experts...

IC-R9500 The Ultimate Wide Band Receiver

- 0.005–3335.000MHz*
- USB, LSB, CW, FSK, FM, WFM, AM
- 1020 Alphanumeric Memory Channels
- P25 (Option UT-122)
- Five Roofing Filters and so much more!



For those just getting started...



IC-R75 Wide Band Receiver

- 0.03–60.0 MHz*
- Triple Conversion
- Twin Passband Tuning
- Digital Signal Processing (DSP)

AND for those on the go!

IC-R20 Advanced Ops

- RX: 0.150–3304.999MHz*
- AM, FM, WFM, SSB, CW
- 1250 Alphanumeric Memory Channels
- Dualwatch Receive
- 4-hour Digital Recorder



IC-RX7 Track Ready

- RX: 0.150–1300.0MHz*
- AM, FM, WFM
- 1825 Alphanumeric Memory Channels
- 100 Ch/Second High Speed Scan
- Computer Programmable²
- Water Resistance Equivalent to IPX4



IC-R6 Pocket Compact

- RX: .100–1309.995MHz*
- AM, FM, WFM
- 1300 Alphanumeric Memory Channels
- 100 Ch/Second High Speed Scan
- Computer Controllable¹



IC-R2500 2 Wide Band RX in 1 Black Box

- RX: 0.01–3299.99MHz*
- AM, FM, WFM, SSB, CW (Main)
- AM, FM and WFM (Sub)
- 1000 Memory Channels
- Optional D-STAR (UT-118)
- Optional P25 (UT-122)
- Optional DSP (UT-106)
- PC Controllable



IC-PCR1500 The Original "Black Box"

- RX: 0.01–3299.99MHz*
- AM, FM, WFM, SSB, CW
- Record and Save Audio as .WAV File
- USB Cable Connection
- Optional DSP

Limited Time Only!
See your dealer for details.

*Frequency specs may vary. Refer to owner's manual for exact frequency specs. ¹Optional CT-17 required. ²Optional CS-RX7 required.
©2012 Icom America Inc. The Icom logo is a registered trademark of Icom Inc. All specifications are subject to change without notice or obligation. 30704

